

GRX-4SLB 4 Button Control

Description

The GRX-4SLB-DW Architrave™ Style Control provides local access to the Lighting Control System to:

- Select groups of scenes in the Lighting Control System.
- Temporarily change the light settings for the current scene.
- Turn lighting zones Off/On.

Important Notes

1. READ ALL INSTRUCTIONS CAREFULLY BEFORE STARTING INSTALLATION.
2. This control must be installed by a qualified electrician.
3. Install in accordance with the National Electric Code and all applicable local regulations.
4. Turn power OFF at the control panel before installing controls. Do not connect high-voltage power to low-voltage terminals. Improper wiring can result in personal injury and damage to the control or to other equipment.
5. Use only a cloth with warm water and mild soap to clean face-plates (no chemical cleaners).

Wiring Notes

- System Maximums:
 - 8 Unique *GRAFIK Eye* addresses per system.
 - 16 WallStations per system.
 - *GRAFIK Eye* 3000 Series Control Units can power a maximum of 3 WallStations.
 - 2000 ft. (610 m) wiring length.
 - 0 °C—40 °C operating temperature.
 - Power: wires 1 & 2, 12 VDC-24 VFW.
 - Data: wires 3 & 4, twisted pair.
- Terminal 2 (power) is not connected between *GRAFIK Eye* 3000 Series Control Units.

Installation



Warning! Always turn Off the circuit breaker/MCB or remove the main fuse from the power line before doing any work. Failure to do so can result in serious personal injury.

Proper wiring of WallStations is dependent upon the *GRAFIK Eye* Control System that is providing power. *GRAFIK Eye* 3000 Series and *GRAFIK Eye* 4000 Series Control Units have different power limitations and wiring techniques. Please confirm the type of Control Unit to which the WallStation is being wired and use the corresponding instructions that follow.

1. Turn power Off.
2. Strip insulation from wires so that 3/8 in. (10 mm) of bare wire is exposed for #18 AWG (1.0 mm²) wire.

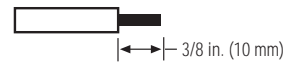

Each WallStation terminal accepts up to two #18 AWG (1.0 mm²) wires. Wiring must be done in a daisy-chain configuration.

3. Address WallStations. Each WallStation in a system **must** be assigned a unique address. Set DIP switches 1—4 of each WallStation to one of the positions illustrated below and record its location.

For this address

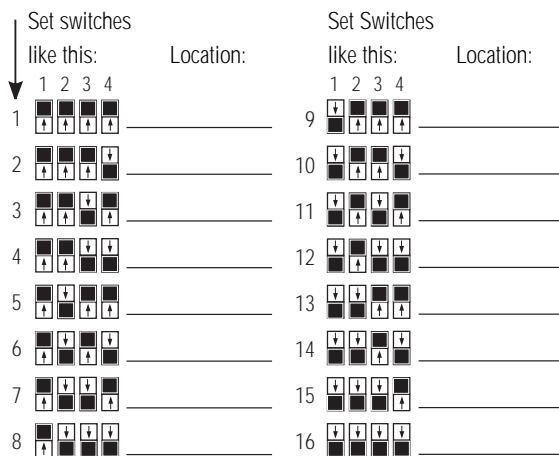

4. Select function. Set DIP switches 5 and 6 on the WallStation to select its function. DIP switch settings and their corresponding function are shown below.

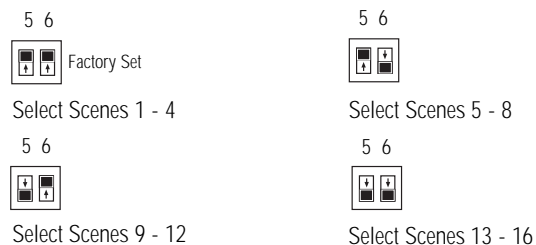
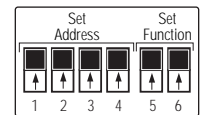

3000 Series System Wiring. Connect four #18 (1.0 mm²) twisted pair wires to the Wallstation's terminal block.

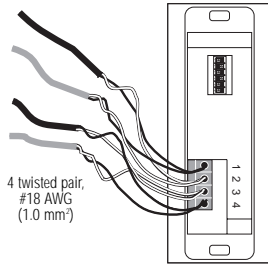

3000 Series System Wiring

4000 Series System Wiring. Connect two #18 (1.0 mm²) shielded, twisted pair wires to terminals 3 and 4 of the Wallstation's terminal block. Shielding/drain must be connected as shown, but do not connect to Earth/Ground or Wallstation*. Two #12 AWG (2.5 mm²) power wires will not fit in the terminal blocks, however, #12 AWG (2.5 mm²) is necessary due to voltage drop on the wire. Use the diagram shown below to make the connections in the wallbox.

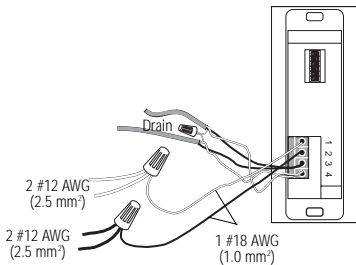

4000 Series System Wiring

Note: Use the wire connector required by local code (those shown are common in the USA).

* **Please note** that shielding/drain wires are connected to the terminal marked "D", when available.

5. Wiring must be done in a daisy-chain and 1-to-1 configuration (please see Installer's Guide included with Control Unit for more information). Each Wallstation terminal will accept up to two #18 AWG (1.0 mm²) wires.

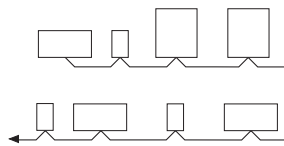

Daisy-Chain Configuration

6. Mount control as shown in diagram below with or without optional Lutron wallbox (P/N 241-663).

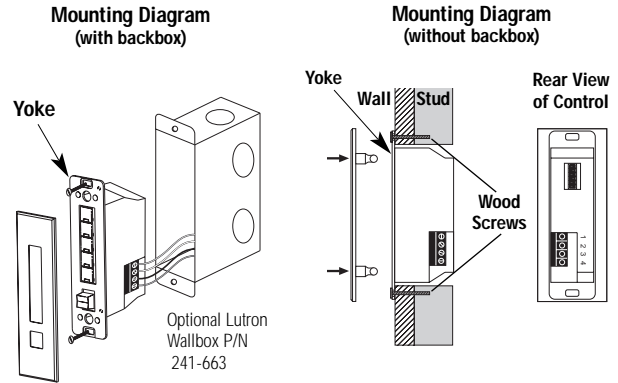

System Communications

In order for Wallstations to communicate with a Control Unit, each Wallstation must be individually configured to "talk" by putting the Wallstation in setup mode.

- Put the NTGRX-4SLB-DW in setup mode (only one Wallstation can be in setup mode at a time).
 - Press and hold the buttons indicated for about 3 seconds, until the LED(s) start cycling.

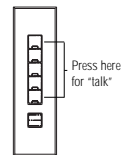

- Identify the Control Unit(s) that you want to "listen" to this Wallstation. (Control Units must be addressed in order for them to "listen"!)
 - Press and hold the top Scene button on the Control Unit for about 3 seconds, until the LEDs flash in unison. Repeat for each Control Unit that you want to "listen" to the Wallstation.

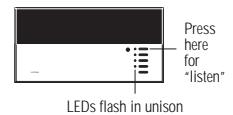

Note: To make a "listening" Control Unit **not** listen to a Wallstation: Put the Wallstation in setup mode, then press the "listening" Control Unit's OFF button until the LEDs stop flashing.

- Exit setup mode. Press and hold the same buttons indicated in Step 1 (above) for about 3 seconds until the LEDs stop cycling (or flashing).

Internet: www.lutron.com
E-mail: product@lutron.com

WORLD HEADQUARTERS
Lutron Electronics Co. Inc.,
TOLL FREE: (800) 523-9466
(U.S.A., Canada, Caribbean)
Tel: (610) 282-3800
International ++1-610-282-3800
Fax: (610) 282-1243
International ++1-610-282-1243

GREAT BRITAIN
Lutron EA Ltd.,
Tel: (171) 702-0657;
International ++44-(0)207-702-0657
Fax: (171) 480-6899;
International ++44-(0)207-480-6899

GERMANY
Lutron Electronics GmbH
Tel: (309) 710-4590;
International ++49-30-97-10-4590
Fax: (309) 710-4591;
International ++49-30-97-10-4591

FRANCE
Lutron LTC
International ++33-(0)1-44-70-71-86
Int'l Fax: ++33-(0)1-44-70-70-97

ASIAN HEADQUARTERS
Lutron Asuka Corporation (Japan)
Tel: (03) 5405-7333;
International ++81-3-5405-7333
Fax: (03) 5405-7496;
International ++81-3-5405-7496

HONG KONG SALES OFFICE
Lutron GL (Hong Kong)
Tel: 2104-7733;
International ++852-2104-7733
Fax: 2104-7633;
International ++852-2104-7633

SINGAPORE
Lutron GL (Singapore)
Tel: ++65-220-4666
Fax: ++65-220-4333

LIMITED WARRANTY

Lutron will, at its option, repair or replace any unit that is defective in materials or manufacture within one year after purchase. For warranty service, return unit to place of purchase or mail to Lutron at 7200 Suter Rd., Coopersburg, PA 18036-1299, postage pre-paid.

This warranty is in lieu of all other express warranties, and the implied warranty of merchantability is limited to one year from purchase. This warranty does not cover the cost of installation, removal or reinstallation, or damage resulting from misuse, abuse, or improper or incorrect repair, or damage from improper wiring or installation. This warranty does not cover incidental or consequential damages. Lutron's liability on any claim for damages arising out of or in connection with the manufacture, sale, installation, delivery, or use of the unit shall never exceed the purchase price of the unit.

This warranty gives you specific legal rights, and you may also have other rights which vary from state to state. Some states do not allow limitations on how long an implied warranty lasts, so the above limitation may not apply to you. Some states do not allow the exclusion or limitation of incidental or consequential damages, so the above limitation or exclusion may not apply to you.

This product may be covered under one or more of the following U.S. patents: 4,803,380; 4,835,343; 5,463,286; 5,530,322 and corresponding foreign patents

Architrave is a trademark of Lutron Electronics Co., Inc.
Lutron and GRAFIK Eye are registered trademarks of Lutron Electronics Co., Inc.
© 2001 Lutron Electronics Co., Inc.

LUTRON

Lutron Electronics Co., Inc.
Made and printed in U.S.A.
P/N 030-720 Rev. A 7/01