

Dimmer Installation Instructions

Please Leave for Occupant

Electronic Low-Voltage Dimmer

VTELV-600M: 120 V~ 60 Hz 600 W

Companion Dimmer

VT-AD: 120 V~ 60 Hz 8.3 A 277 V~ 60 Hz 6 A

This Dimmer is used to control the primary side of electronic transformer-supplied low-voltage lighting, incandescent lamps, or a combination of the two.

Important Notes

Please read before installing.

- To avoid overheating and possible damage to other equipment, do not use to control receptacles, fluorescent lighting fixtures, motor-operated or transformer-supplied appliances.
- Some fixture manufacturers do not recommend dimming their solid-state transformers. To determine if a fixture can be dimmed, consult the fixture manufacturer.
- Install in accordance with all national and local electrical codes.
- The Electronic Low-Voltage Dimmer (Main Dimmer) requires a neutral wire for operation. If no neutral wire is present, contact a licensed electrician for installation.
- A neutral wire is not necessary for the installation of the Companion Dimmer (VT-AD).
- The Main Dimmer must be wired on the load-side of a multi-location circuit.
- When "no grounding means" exists within the wallbox, then the NEC 2008, Article 404.9 allows a switch without a grounding connection to be installed as a replacement, as long as a plastic, noncombustible wallplate is used. For this type of installation, twist a wire connector onto the green ground wire of the Dimmer or remove the green ground wire.
- The Main Dimmer is not compatible with standard 3-way switches. Use only with a Companion Dimmer.
- Companion Dimmers must be used in conjunction with a Main Dimmer in a 3-way/4-way application.
- In any 3-way/4-way circuit, use only one Main Dimmer with up to four Companion Dimmers.
- Do not use where total load is greater than the rating indicated in the Derating Chart below.
- Operate between 32 °F (0 °C) and 104 °F (40 °C).
- The Main Dimmer may feel warm to the touch during normal operation.
- Recommended wallbox depth is 2.5 in (64 mm) minimum.
- Maximum total wire length between all Verti® devices is 250 ft (76 m).
- For new installations, install a test switch before installing the Dimmer or test with a breaker.
- Do not paint the Main Dimmer or Companion Dimmer.

Multigang Installation

Verti wallplates are available in one to six gang versions. When combining controls in a wallbox, the Main Dimmer must be derated; see the Derating Chart below.

Note: Companion Dimmers do not need to be derated.

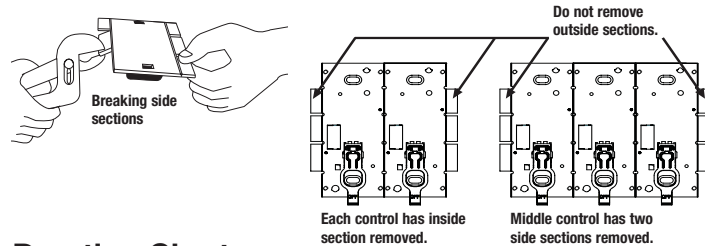

Derating Chart

Dimmer Type	Maximum Load		
	No Sides Removed	1 Side Removed	2 Sides Removed
VTELV-600M	600 W	500 W	400 W

Preparing for Installation

1 Turn the Power OFF

- Turn the power OFF at the circuit breaker (or remove the fuse).



WARNING: Verify that power is OFF before proceeding. Failure to turn power OFF could cause death or serious injury.

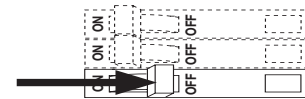

2 Remove Wallplate, Switch, and Wires from Switch

- Remove the wallplate and switch mounting screws.
- Carefully remove the switch from the wall.
- Examine and identify the wires.
- Disconnect wires from switch **Only**.

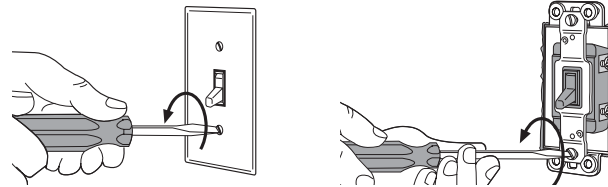

3 Check the Wiring

3a This Dimmer requires special wiring to control electronic low-voltage fixtures.

Before starting, make sure that the wires shown below are available in your wallbox. If these wires are not available in your wallbox, contact a licensed electrician to have them installed.

All wiring must comply with national and local electrical codes.

Required Wires for Main Dimmer

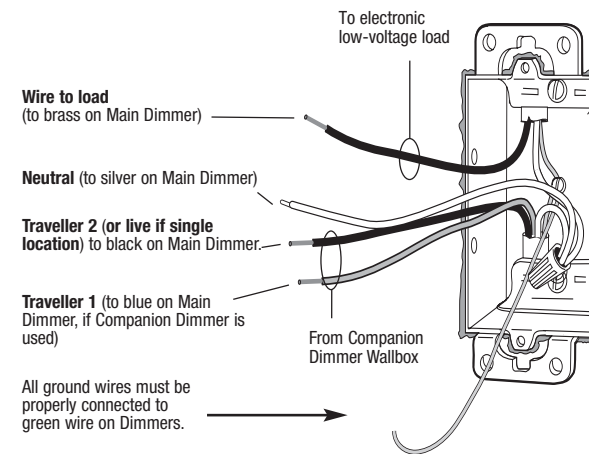

Required Wires for First Line-Side Companion Dimmer (Multi-Location only)

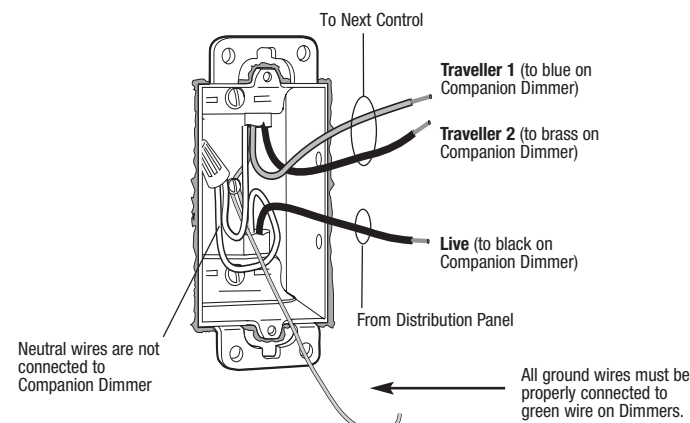

3b

Check new installations for short or open circuits **BEFORE** installing the Dimmer.

Proceed as follows:

- Make certain that the power has been turned OFF at the circuit breaker or that the fuse has been removed.
- Connect a standard switch as shown in the Test Switch Wiring Diagram below.
- Turn the power ON at the circuit breaker box or replace the fuse.
- Turn the switch ON.
If lights do not come on, there is a break in the wiring. If the breaker trips, there is a short in the wiring. If necessary, turn the power OFF at the circuit breaker box or remove the fuse, correct any wiring problems, and recheck the circuit.
- After the problem has been corrected, remove the test switch before proceeding with the installation.
- If a test switch is not available, use wire connectors to make appropriate connections to turn the lights on.

Test Switch Wiring Diagram

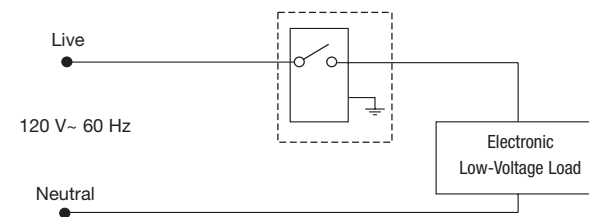

4

Prepare the Dimmer for Installation

- The Dimmer has a pre-installed Verti wallplate. Remove the wallplate before proceeding with the installation.
- The Dimmer has a pre-installed front module containing LEDs. Before proceeding with the installation, grab the module and pull it straight out. Removing the Front Module will expose the mounting holes.

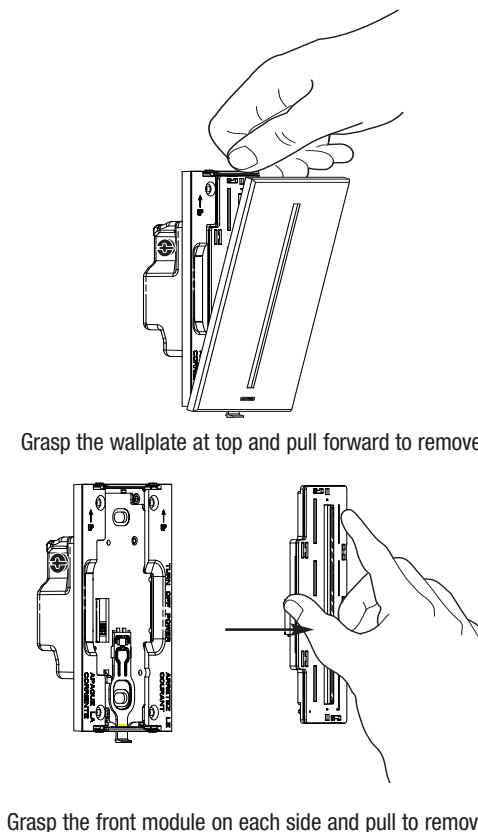

5

Wire the Main Dimmer and Companion Dimmer(s)

Important Wiring Information

When making wire connections, follow the recommended strip lengths and combinations for the supplied wire connector.
Note: All wire connectors provided are suitable for **copper wire only**. For aluminum wire, consult an electrician.

Wire Connector: Use to join 12 AWG (2.5 mm²) or 14 AWG (1.5 mm²) ground wire to 18 AWG (0.75 mm²) Dimmer wire.

Trim or strip wallbox wires to the length indicated by the strip gauge on the back of the Dimmer.

Push-In Terminals: Insert wires fully.

Note: Push-in terminals are for use with 14 AWG (1.5 mm²) **solid copper wire only**. DO NOT use stranded or twisted wire.

or

Screw Terminals: Tighten securely. Screw terminals are for use with 12 AWG (2.5 mm²) or 14 AWG (1.5 mm²) **solid copper wire only**. DO NOT use stranded or twisted wire.

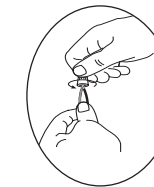

Twist wire connector tight.

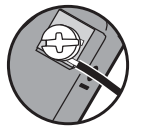
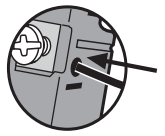

- For installations involving more than one control in a wallbox, refer to Multigang Installation before beginning.

5a - Single-Pole Wiring

Before beginning, make absolutely sure that the power is OFF!

Wiring the Main Dimmer (Only the Main Dimmer is used in this installation.)

- Connect the green ground wire to the bare or green ground wire in the wallbox.
- Black screw:** Connect the live supply wire (120 V~), disconnected from the removed switch, to this screw.
- Brass screw:** Connect the other wire (disconnected from the removed switch - **Dimmed Live**) going to the black wire of the electronic low-voltage transformer, to this screw.
- Blue screw:** Tighten the blue screw. **The blue screw is not used in a single-pole circuit.**
- Silver screw:** Connect the neutral wire in the wallbox to this screw.

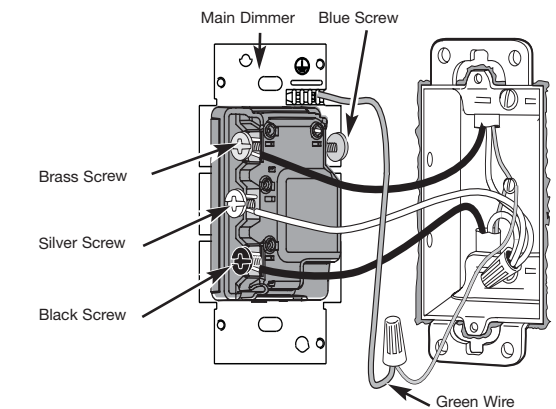

Single-Pole Wiring Diagram

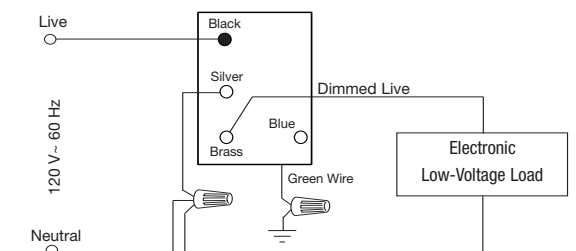

Go to step 6.

5b - 3-Way Wiring (Two Locations)

Before beginning, make absolutely sure that the power is OFF!

Wiring the Companion Dimmer on the line-side.

1. Connect the green ground wire to the bare or green ground wire in the wallbox.
2. **Black screw:** Connect the live wire (120 V~), disconnected from the removed switch, to this screw.
3. **Brass screw:** Connect wire (Traveller 2 - note wire color) to this screw.
4. **Blue screw:** Connect wire (Traveller 1 - note wire color) to this screw.

Wiring the Main Dimmer on the load-side.

1. Connect the green ground wire to the bare or green ground wire in the wallbox.
2. **Black screw:** Connect wire (Traveller 2) coming from the brass screw of the Companion Dimmer to this screw.
3. **Brass screw:** Connect the other wire (disconnected from the removed switch - Dimmed Live) going to the black wire of the electronic low-voltage transformer to this screw.
4. **Blue screw:** Connect wire (Traveller 1) coming from the blue screw of the Companion Dimmer to this screw.
5. **Silver screw:** Connect the neutral wire in the wallbox to this screw.

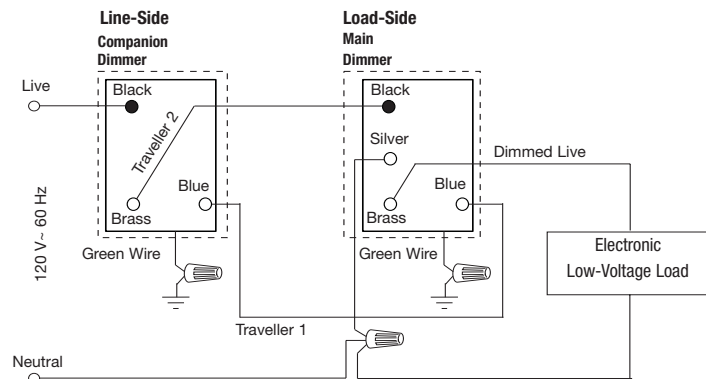

Go to step 6.

5c - 4-Way Wiring (Three to Five Locations)

Before beginning, make absolutely sure that the power is OFF!

Notes:

- Only one location can be a Main Dimmer. The other locations must be Companion Dimmers with up to four Companion Dimmers in an installation.
- The Companion Dimmer does not have a silver screw (no neutral required).

Wiring the first Companion Dimmer on the line-side.

1. Connect the green ground wire to the bare or green ground wire in the wallbox.
2. **Black screw:** Connect the live wire (120 V~) (disconnected from the removed switch) to this screw.
3. **Brass screw:** Connect wire (Traveller 2) from this screw to the black screw of the next (middle) Companion Dimmer (note wire color).
4. **Blue screw:** Connect wire (Traveller 1) from this screw to the blue screw of the next (middle) Companion Dimmer (note wire color).

Wiring the middle Companion Dimmer(s).

1. Connect the green ground wire to the bare or green ground wire in the wallbox.
2. **Black screw:** Connect the wire coming from the brass screw of the previous line-side Companion Dimmer (see above) to this screw.
3. **Brass screw:** Connect a wire from this screw to the black screw of the next load-side Companion Dimmer or the Main Dimmer (note wire color).
4. **Blue screw:** Connect the wire coming from the blue screw of the first Companion Dimmer to this screw. This wire will then continue to the blue screw of the Main Dimmer or next load-side Companion Dimmer.

Wiring the Main Dimmer.

1. Connect the green ground wire to the bare or green ground wire in the wallbox.
2. **Black screw:** Connect the wire coming from the brass screw of the middle Companion Dimmer(s) to this screw.
3. **Brass screw:** Connect the other wire (disconnected from the removed switch - Dimmed Live) going to the black wire of the electronic low-voltage transformer to this screw.
4. **Blue screw:** Connect the wire coming from the blue screws of the first and middle Companion Dimmer(s) to this screw.
5. **Silver screw:** Connect the neutral wire in the wallbox to this screw.

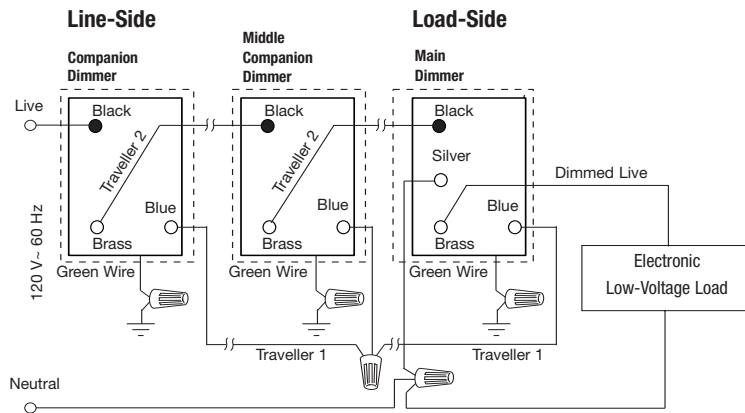

Go to step 6.

6 Mount the Dimmer or Companion Dimmer(s) to the Wallbox

- Form wires carefully into the wallbox, mount and align Dimmer (or Companion Dimmer).
- Install the front module and the wallplate.

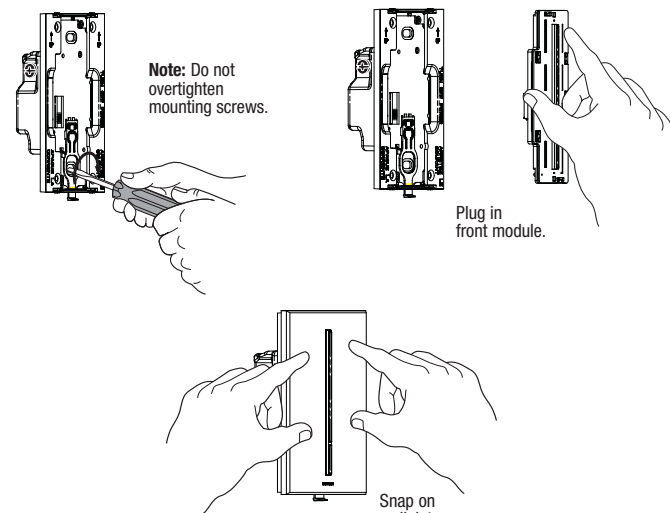

7 Turn Power ON

- Turn the power ON at the circuit breaker (or replace the fuse).

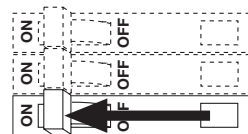

8 Dimmer Operation

Turning the System On/Off

Turn the system on by pushing the Front Accessible Service Switch (FASS™) up. Pulling the FASS switch down removes power from the load.

Note: The FASS switch is not used during normal operation.

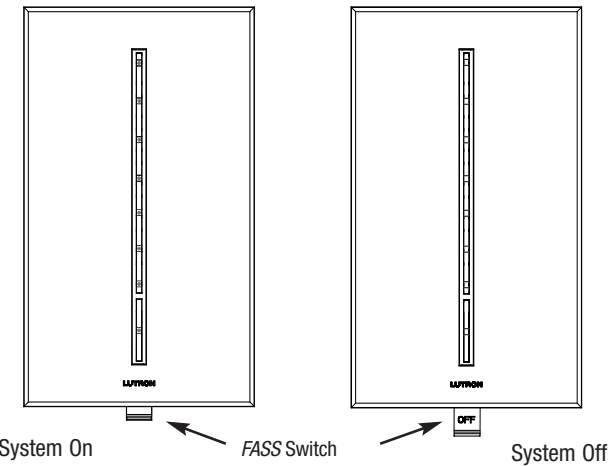

Important Notice:

To replace lamps, power may be conveniently removed by pulling the FASS switch down on the Dimmer or any Companion Dimmer. For any procedure, other than routine lamp replacement, power must be turned OFF at the main electrical panel.

Dimmer Functions

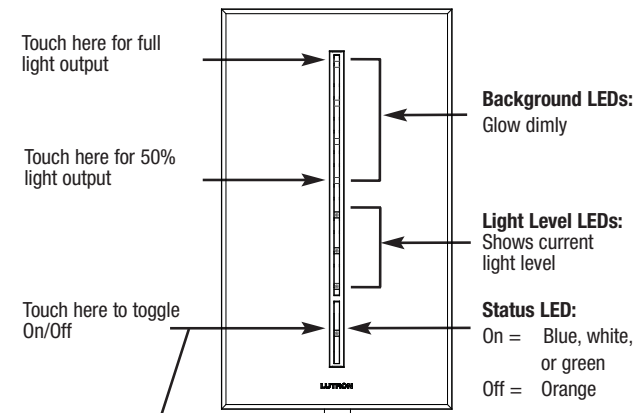

Touch and hold for delayed fade to off. As this region is held, an LED will begin to flash, and the lights will begin to fade off with a 30 second delay.

Advanced Programming Mode

The following *Verti* Dimmer settings can be modified using the Advanced Programming Mode:

- High/Low End Trims
- LED Brightness
- Sound Off/On
- Delayed Fade Wait Time
- Off Fade Time
- On Fade Time
- Locked Preset

Consult Application Note #205 on how to use the Advanced Programming Mode. Please visit www.lutron.com/verti or call **Lutron Technical Support**.

Troubleshooting

Symptom	Possible Cause
Light does not turn on and no LEDs light up.	<ul style="list-style-type: none"> • The FASS switch on the Dimmer or Companion Dimmer(s) is pulled down to the off position. • Breaker is OFF or tripped. • Dimmer is miswired. Check wiring.
Light turns on and Dimmer works, but Companion Dimmer does not work.	<ul style="list-style-type: none"> • Wire connected to the blue screw terminal on the Dimmer is not the same wire connected to the blue screw terminal on the Companion Dimmer. Check wiring.
LEDs scroll up and down.	<ul style="list-style-type: none"> • Dimmer has encountered an error condition. Call Lutron Technical Support.
Dimmer appears to work (LEDs light up) but light does not turn on.	<ul style="list-style-type: none"> • The Dimmer terminal wires connected to the black and brass screws are reversed. Switch the wires. • Lamps burned out.
Dimmer works properly, then shuts off.	<ul style="list-style-type: none"> • Dimmer is overloaded or load type is wrong. Check the load.

Worldwide Technical and Sales Assistance

For questions concerning the installation or operation of these products, call the **Lutron Technical Support Center**. Please provide the exact model number when calling.

1.800.523.9466 (U.S.A., Canada, and the Caribbean)

Other Countries call +1.610.282.3800

Fax +1.610.282.6311

Visit our web site at www.lutron.com

Limited Warranty

(Valid only in U.S.A., Canada, Puerto Rico, and the Caribbean.)

Lutron will, at its option, repair or replace any unit that is defective in materials or manufacture within one year after purchase. For warranty service, return unit to place of purchase or mail to Lutron at 7200 Suter Rd., Coopersburg, PA 18036-1299, postage pre-paid.

THIS WARRANTY IS IN LIEU OF ALL OTHER EXPRESS WARRANTIES, AND THE IMPLIED WARRANTY OF MERCHANTABILITY IS LIMITED TO ONE YEAR FROM PURCHASE. THIS WARRANTY DOES NOT COVER THE COST OF INSTALLATION, REMOVAL OR REINSTALLATION, OR DAMAGE RESULTING FROM MISUSE, ABUSE, OR DAMAGE FROM IMPROPER WIRING OR INSTALLATION. THIS WARRANTY DOES NOT COVER INCIDENTAL OR CONSEQUENTIAL DAMAGES. LUTRON'S LIABILITY ON ANY CLAIM FOR DAMAGES ARISING OUT OF OR IN CONNECTION WITH THE MANUFACTURE, SALE, INSTALLATION, DELIVERY, OR USE OF THE UNIT SHALL NEVER EXCEED THE PURCHASE PRICE OF THE UNIT.

This warranty gives you specific legal rights, and you may have other rights, which vary from state to state. Some states do not allow the exclusion or limitation of incidental or consequential damages, or limitation on how long an implied warranty may last, so the above limitations may not apply to you. This product is covered under one or more of the following U.S. patents: 5,017,837; 5038,081; 5,248,919; 5,510,679; 6,169,377; 7,190,125, D563,901, and corresponding foreign patents. U.S. and foreign patents pending. Lutron and Verti are registered trademarks and FASS is a trademark of Lutron Electronics Co., Inc. NEC is a registered trademark of National Fire Protection Association, Quincy, Massachusetts.
© 2008 Lutron Electronics Co., Inc.