

Description

The GRX-CIR receives signals from the GRAFIK Eye GRX-IT or GRX-8IT Handheld Wireless Remote Control to activate scenes on the GRAFIK Eye 3000 or 4000 Control Unit. It requires an unobstructed line-of-sight for receiving the signal (Remote Control pointed directly at the GRX-CIR's receiver). The GRX-CIR offers 360° activation and a range of up to 50 feet (15 m).

READ ALL INSTRUCTIONS CAREFULLY BEFORE STARTING INSTALLATION!

CAUTION!

- Install in accordance with all applicable regulations.
- The GRX-CIR is a Class 2/PELV control; do not connect line-voltage/mains cable to Class 2/PELV terminals. Improper wiring can result in personal injury or damage to the control or to other equipment.
- GRAFIK Eye Wallstations must be connected to the GRAFIK Eye Control Unit by using Class 2/PELV wiring methods per the National Electrical Code. Check with your local electrical inspector for the local code requirements and wiring practices allowed in your area.

Wiring Notes

Proper wiring of Wallstations is dependent upon the GRAFIK Eye Control System that is providing power. GRAFIK Eye 3000 Series and GRAFIK Eye 4000 Series Control Units have different power limitations and wiring techniques. Please confirm the type of Control Unit to which the Wallstation is being wired and use the corresponding instructions.

■ System Maximums:

- 2000 ft. (600 m) wiring length (based on specified cable). Please see Lutron's Application Note #14 for more details concerning allowable cable runs.
- 0 °C—40 °C (32 °F—104°F) operating temperature.

■ Wallstation Wiring

- **3000 Series:** Four #18 AWG (1.0 mm²) Class 2/PELV wires (2 twisted pair). Lutron offers a one-cable (non-plenum), low-voltage solution (P/N GRX-CBL-346S). Other suggested cables are Belden No. 9156, Alpha No. 1132, or equivalent, for GRAFIK Eye 3000 Series Control Units.
- **4000 Series:** Two #12 AWG (2.5 mm²) Class 2/PELV wires and a twisted, shielded pair of #18 AWG (1.0 mm²) Class 2/PELV wires. Lutron offers a one-cable (non-plenum), low-voltage solution (P/N GRX-CBL-46L).
- Power: wires 1 & 2, 12 VDC-24 VFW.
- Data: wires 3 & 4, twisted pair.

■ Terminal 2 (power) is not connected between GRAFIK Eye 3000 Series Control Units.

■ Do NOT touch the lens on the receiver.

■ Do NOT locate a GRX-CIR near ventilation ducts, lighting fixtures, or in direct sunlight.

■ Locate the GRX-CIR to allow line-of-sight reception of infrared signals.

Installation

1. Trace the 2.2" square template (below) onto the ceiling where the receiver will be mounted. Using a knife or a saw, cut out the square.

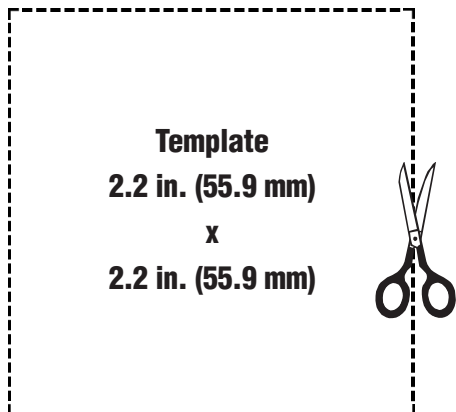

2. Place the Metal collar into the hole with the four "fingers" up and press it tightly against the ceiling.

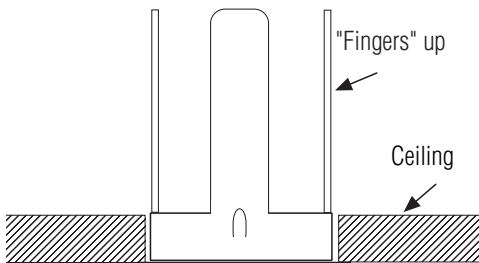

3. While keeping the collar pressed tightly against the ceiling, reach through the collar and bend all four "fingers" down tightly against the ceiling so that the collar does not sag.

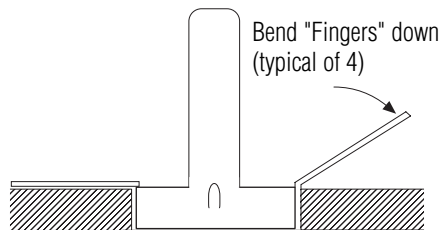

4. Address the Control Units. To assign addresses to the GRAFIK Eye 3000 or 4000 Control Units, see the Instructions shipped with each Unit.
5. Address the GRX-CIR. Each GRX-CIR in a system MUST be assigned a unique address. Set DIP switches 1—4 on each GRX-CIR to one of the positions illustrated on Page 4 and record its location.

For this Address:

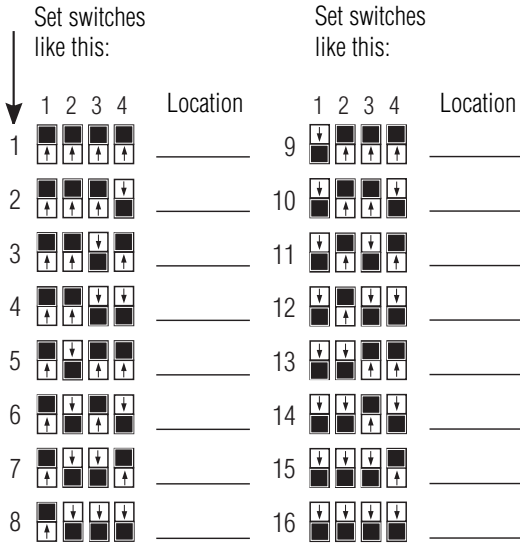

6. Select function. Set DIP switches 5 and 6 on the GRX-CIR to select its function (functions when using a GRX-8IT are shown in parantheses).

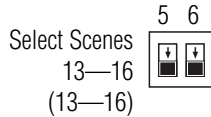
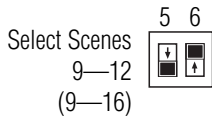
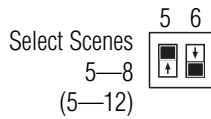
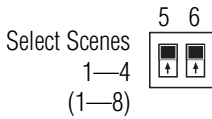

- Strip insulation from wires so that 3/8 in. (10 mm) of bare wire is exposed.
- Wiring must be done in a daisy-chain and 1-to-1 configuration (please see Installer's Guide included with Control Unit for more information).

3000 Series System Wiring: Connect four #18 AWG (1.0 mm²) twisted pair wires to the GRX-CIR as shown at right.

4000 Series System Wiring: Connect one of the #18 AWG (1.0 mm²) shielded, twisted pair wires to the GRX-CIR's blue lead, and the other wire to the yellow lead. Connect one #12 AWG (2.5 mm²) wire to the GRX-CIR's red lead, and the other #12 AWG (2.5 mm²) wire to the white/black lead. Please note that #12 AWG (2.5 mm²) is necessary due to voltage drop on the wire. The Drain wire must also be daisy-chained, but do not connect to Earth/Ground or GRX-CIR.

Use the diagrams on the next page to make the connections in the wallbox.

3000 Series Control Unit

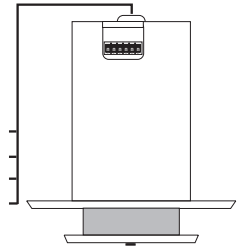
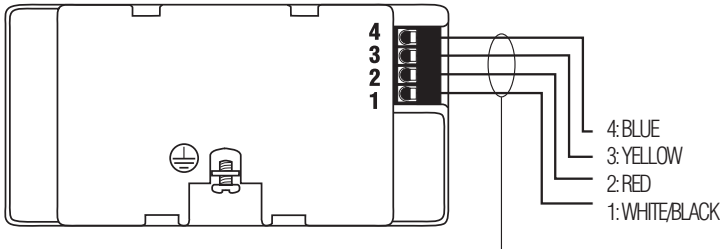

CLASS 2/PELV WIRING
4: MUX 2: 12 DC
3: MUX 1: COMMON

4000 Series Control Unit

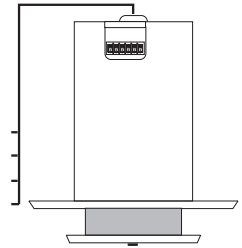
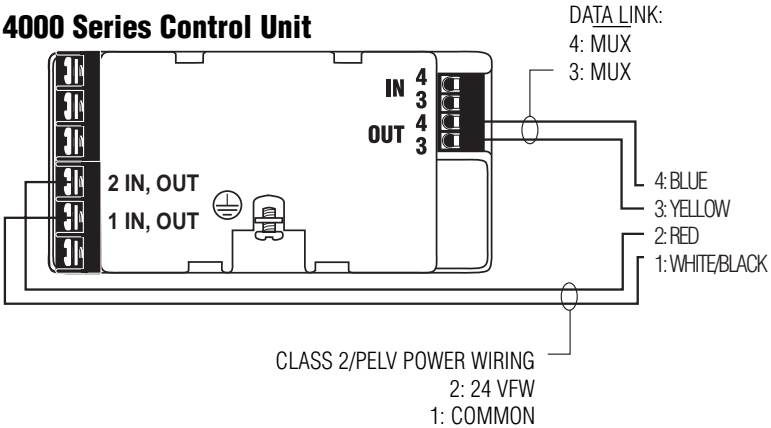

9. Mount the GRX-CIR by pushing the unit up and into the Metal Collar as shown at right.

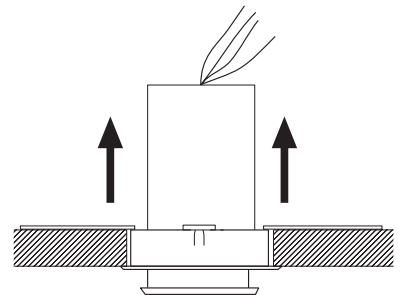

System Communications

In order for the GRX-CIR to communicate with a Control Unit, each GRX-CIR must be individually configured to “talk” by putting the GRX-CIR in setup mode (only one GRX-CIR can be in setup mode at a time). The GRX-CIR can be put into setup mode only by using a GRX-IT or GRX-8IT Handheld Wireless Remote Control.

1. To enter setup mode: Point the Remote Control directly at the GRX-CIR’s receiver and then press and hold the buttons indicated for about 3 seconds, until the GRX-CIR’s LED starts flashing.

2. Identify the Control Unit(s) that you want to “listen” to this GRX-CIR. (Control Units **must** be addressed!)

Press and hold the top Scene button on the Control Unit for about 3 seconds, until the Control Unit’s LEDs flash in unison. Repeat for each Control Unit that you want to “listen” to this GRX-CIR.

Note: (To make a “listening” Control Unit not listen to a GRX-CIR: Put the GRX-CIR in setup mode, then press the “listening” Control Unit’s OFF button until the Control Unit’s LEDs stop flashing.)

3. **Exit setup mode.** Press and hold the buttons indicated in Step 1 for about 3 seconds, until the GRX-CIR’s LED stops flashing.

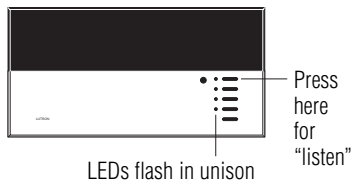
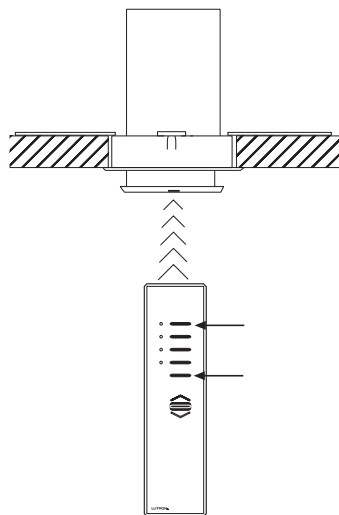

Troubleshooting

Please be sure that the Handheld Wireless Remote Control's batteries are charged and inserted properly!

Symptom	Causes	Solution
GRX-CIR will not go into Program Mode; programming LED is not lit.	Power is off.	Restore power at power panel.
	Miswire.	Confirm all connections. Correct swapped wires in daisy-chain. Connect all wires in multicontrol chain.
	GRAFIK Eye Control Units do not have addresses.	Address GRAFIK Eye Control Units.
GRX-CIR does not work.	Miswire.	Confirm all connections.
	GRAFIK Eye Control Units are not programmed.	Address GRAFIK Eye Control Units (see instructions shipped with Control Unit) and program the GRX-CIR per the installation instructions.
GRX-CIR is intermittent or is not working at all.	GRX-CIR does not have a unique Address.	Confirm that the GRX-CIR has a unique Address as set by the DIP switches on the control.

Wallstation circuits are classified as Class 2 circuits (U.S.A.) and PELV circuits (IEC). Unless otherwise specified, the voltages do not exceed 24 VAC or 15 VDC. As Class 2 circuits, they comply with the requirements of NFPA 70. National Electrical Code (NEC). As PELV circuits, they comply with the requirements of IEC 60364-4-41, VDE 0100 Part 410, BS7671:1992 and other equivalent standards. When installing and wiring to these Wallstations, follow all applicable national and/or local wiring regulations. External circuits connected to input, output, RS232, DMX512, and other communication terminals of Wallstations, must be supplied from a Listed Class 2 source or comply with the requirements for PELV circuits as applicable in your country.

Internet: www.lutron.com
E-mail: product@lutron.com

WORLD HEADQUARTERS
Lutron Electronics Co. Inc.,
TOLL FREE: (800) 523-9466
(U.S.A., Canada, Caribbean)
Tel: (610) 282-3800;
International 1- 610-282-3800
Fax: (610) 282-3090;
International 1-610-282-3090

GREAT BRITAIN
Lutron EA Ltd.,
Tel: (171) 702-0657;
International 44-171-702-0657
Fax: (171) 480-6899;
International 44-171-480-6899

GERMANY
Lutron Electronics GmbH BCA
Tel: (309) 710-4590;
International 49 309 710-4590
Fax: (309) 710-4591;
International 49 309 710-4591

ASIAN HEADQUARTERS
Lutron Asuka Corporation
Tel: (03) 5405-7333;
International 81-3-5405-7333
Fax: (03) 5405-7496;
International 81-3-5405-7496

HONG KONG SALES OFFICE
Lutron GL (Hong Kong)
Tel: 2104-7733;
International 852-2104-7733
Fax: 2104-7633;
International 852-2104-7633

SINGAPORE
Lutron GL (Singapore)
Tel: 65 220 4666
Fax: 65 220 4333

WARRANTY

Lutron warrants each new unit to be free from defects in materials and workmanship and to perform under normal use and service. This warranty shall run only for a period of one year from the date of purchase and Lutron's obligations under this warranty are limited to remedying any defect or replacing any defective part and shall be effective only if the defective unit is shipped to Lutron postage prepaid within 12 months after purchase. Damage due to abuse, misuse, inadequate wiring or installation is not covered by this warranty.

In no event shall Lutron or any other seller be liable for any other loss or damage, including consequential or special damages that may arise through the use by a purchaser or others of this device and the purchaser assumes and will hold harmless Lutron in respect of all such loss.

Although every attempt is made to ensure that catalogue information is accurate and up-to-date, please check with Lutron before specifying or purchasing this equipment to confirm availability, exact specifications, and suitability for your application.

Lutron and GRAFIK Eye are registered trademarks of Lutron Electronics Co., Inc.

© 1999 Lutron Electronics Co., Inc.

LUTRON®

Lutron Electronics Co., Inc.
Made and printed in U.S.A.
P/N 030-616 Rev.A 9/99