

## Troubleshooting

Symptom	Possible Cause
Light does not turn on, but LED on switch is on.	<ul style="list-style-type: none"> <li>Lamps burned out or not installed properly.</li> <li>Switch is not properly wired.</li> </ul>
Light does not turn on, and LED on switch is off.	<ul style="list-style-type: none"> <li>Front Accessible Service Switch (FASS) on the switch is to the left (see Step 4).</li> <li>Breaker is off or tripped.</li> <li>Switch is not properly wired.</li> </ul>

The *Spacer System* switch is currently UL listed for use with the following ballasts:

Manufacturer	Model No.
Advance Transformer Co.	REL-2P32-RH-TP
Magnetek	B2321120RH
GE Lighting/ Motorola Lighting Inc.	G2-RN-T8-1LL-120
Valmont Electric	E232P1120G01
Sylvania	QT2X32/120IS

Please call the **Lutron Technical Support Center** for an up to date listing.

## Worldwide Technical and Sales Assistance

If you have questions concerning the installation or operation of this product, call the **Lutron Technical Support Center**. Please provide exact model number when calling.

+1-800-523-9466 (U.S.A., Canada, and the Caribbean)

+1-888-235-2910 (Mexico)

Other countries call +1-610-282-3800

Fax +1-610-282-3090

Visit our web site at [www.lutron.com](http://www.lutron.com)

# LUTRON®

Symptom	Possible Cause
Switch does not respond to the <i>Spacer System</i> Infrared Hand-held Remote Control (transmitter).	<ul style="list-style-type: none"> <li>Transmitter batteries are installed incorrectly.</li> <li>Transmitter batteries are dead or low.</li> <li>Transmitter is not aimed at the <i>Spacer System</i> switch.</li> <li>Transmitter <b>is not a <i>Spacer System</i></b> transmitter.</li> <li>All scenes are programmed to OFF.</li> </ul>
Switch does not respond to a non-Lutron infrared remote control (transmitter).	<ul style="list-style-type: none"> <li>Transmitter is not a programmable type transmitter (i.e. learnable or stored code).</li> <li>Transmitter was not set up properly.</li> </ul>
<i>Spacer System</i> switch operates normally but does not respond to the SPS-5WC Scene Selector control.	<ul style="list-style-type: none"> <li>There is an obstruction between the Scene Selector control and the <i>Spacer System</i> switch.</li> </ul>

## Limited Warranty

(Valid only in US, Canada, Puerto Rico, and the Caribbean.)

Lutron will, at its option, repair or replace any unit that is defective in materials or manufacture within one year after purchase. For warranty service, return unit to place of purchase or mail to Lutron at 7200 Suter Rd., Coopersburg, PA 18036-1299, postage pre-paid.

**THIS WARRANTY IS IN LIEU OF ALL OTHER EXPRESS WARRANTIES, AND THE IMPLIED WARRANTY OF MERCHANTABILITY IS LIMITED TO ONE YEAR FROM PURCHASE. THIS WARRANTY DOES NOT COVER THE COST OF INSTALLATION, REMOVAL OR REINSTALLATION, OR DAMAGE RESULTING FROM MISUSE, ABUSE, OR DAMAGE FROM IMPROPER WIRING OR INSTALLATION. THIS WARRANTY DOES NOT COVER INCIDENTAL OR CONSEQUENTIAL DAMAGES. LUTRON'S LIABILITY ON ANY CLAIM FOR DAMAGES ARISING OUT OF OR IN CONNECTION WITH THE MANUFACTURE, SALE, INSTALLATION, DELIVERY, OR USE OF THE UNIT SHALL NEVER EXCEED THE PURCHASE PRICE OF THE UNIT.**

This warranty gives you specific legal rights, and you may have other rights which vary from state to state. Some states do not allow limitations on how long an implied warranty lasts, so the above limitation may not apply to you. Some states do not allow the exclusion or limitation of incidental or consequential damages, so the above limitation or exclusion may not apply to you.

This product is covered under one or more of the following U.S. patents: 4,835,343; 5,909,087; and corresponding foreign patents. U.S. and foreign patents pending. Lutron, Claro, and Spacer are registered trademarks and FASS, Spacer System, and The Hand are trademarks of Lutron Electronics Co., Inc. NEC is a registered trademark of the National Fire Protection Association, Quincy, Massachusetts.

© 2005 Lutron Electronics Co., Inc.

Lutron Electronics Co., Inc.  
7200 Suter Road  
Coopersburg, PA 18036-1299, U.S.A.  
Made and printed in the U.S.A. 8/05 P/N 030-675 Rev. C

English

P/N 030-675 C

# spacer SYSTEM™

Personal Space Light Control

## Installation Instructions for Single-Location Control

**Please Leave for Occupant**

**Read all instructions completely before installation.**

Use *Spacer System™* infrared hand-held remote controls (SPS-4IT, SPS-FSIT) for programming and recalling lighting scenes, and switching from the palm of your hand.

## Important Notes

- Caution:** To avoid overheating and possible damage to other equipment, do not use to control receptacles, incandescent lighting fixtures, motor-operated or transformer-supplied appliances.
- This switch requires a neutral wire for operation. See wiring requirements in Step 2 (next page) before starting installation.
- When no "grounding means" exist within the wallbox then the NEC® 2002, Article 404-9 allows a dimmer without a grounding connection to be installed as a replacement, as long as a plastic, noncombustible wallplate is used. For this type of installation, cap or remove the green ground wire on the dimmer and use an appropriate wallplate such as Lutron's *Claro®* series wallplates.
- Install in accordance with all national and local electrical codes.
- Do not paint front or back of switch.
- Use only to control electronic fluorescent ballasts.
- Operate between 0 °C (32 °F) and 40 °C (104 °F).
- Switch may feel warm to the touch during normal operation.
- For new installations, wire a test switch before installing the control.
- Recommended wallbox depth is 2 1/2" (64 mm) minimum.
- Clean with a soft damp cloth only.** Do not use any chemical cleaners.

## Switch for Electronic Fluorescent

### Ballasts

SPSF-S6A	120 V Electronic Fluorescent Ballast Switch with IR Receiver
SPSF-S6A-277	277 V Electronic Fluorescent Ballast Switch with IR Receiver

Rated at 120 V~ or 277 V~ 60 Hz  
6 Amp. maximum total current

## Installation Note

**Important:** Switches used together with *Spacer System* dimmers to create scenes with a *Spacer System* wall mounted scene selector (SPS-5WC) must be installed in a single multigang wallbox with no dividers, barriers, or other controls between switches. Individually mounted wallboxes are not acceptable. For scene programming and functions, refer to the instructions supplied with a *Spacer System* infrared hand-held remote control or wall mounted scene selector.

## Multigang Installations

Lutron *Claro* wallplates are available in 1 to 6 gang versions. Purchase *Claro* multigang wallplates separately. When combining switches with other controls in the same wallbox, remove all inner side sections prior to wiring. Using pliers, bend side sections up and down until they break off.

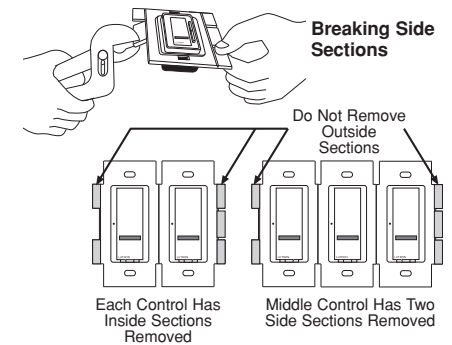

Reduction of the *Spacer System* switch load capacity **is required** when removing side sections. See table below.

	No sides removed	1 side removed	2 sides removed
SPSF-S6A	6 Amps	5 Amps	3.5 Amps
SPSF-S6A-277	6 Amps	5 Amps	3.5 Amps

To determine total ballast load, add the line current found on the ballast label for all the ballasts in the circuit. This will indicate the total load for the switch.



"The Hand™" Infrared Wireless Remote Control **will not** operate the *Spacer System* Dimmers or Switches. Use *Spacer System* infrared hand-held remote controls only (sold separately).

# LUTRON®

## Single-Location Installation

For installations combining switches with other controls in a wallbox, refer to Multigang Installations on page 1 before beginning.

**IMPORTANT NOTE:** This switch requires special wiring to control electronic ballasts. See wiring requirements in Step 2 before starting installation.

✓ Check off Steps as completed.

**Step 1** Turn power off at circuit breaker panel or remove fuse from fusebox.

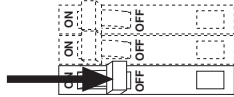

**Step 2** The following wires are required in the wallbox for installation.

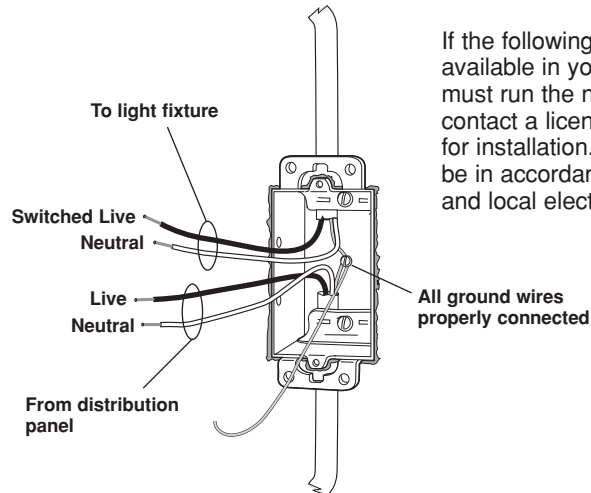

If the following wires are not available in your wallbox, you must run the needed wires or contact a licensed electrician for installation. All wiring must be in accordance with national and local electrical codes.

**Step 3** Wire the *Spacer System* Switch.

Using the wire connectors provided:

- 3a** **Connect the ground wire:**  
Connect the *Spacer System* Switch green ground wire to the bare copper or green ground wire in the wallbox.
- 3b** **Connect the black wire:**  
Connect the *Spacer System* Switch black wire to the live wire coming from the distribution panel.
- 3c** **Connect the red wire:**  
Connect the *Spacer System* Switch red wire to the black wire on the electronic ballast.
- 3d** **Connect the white wire:**  
Connect the *Spacer System* Switch white wire to neutral.

### Wiring Diagram

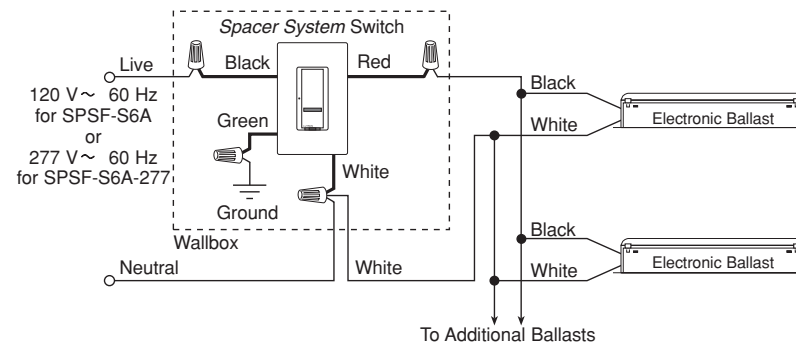

## Operation of *Spacer System* Switch

### Basic Operation

Tap once to turn On.  
Tap again to turn Off.

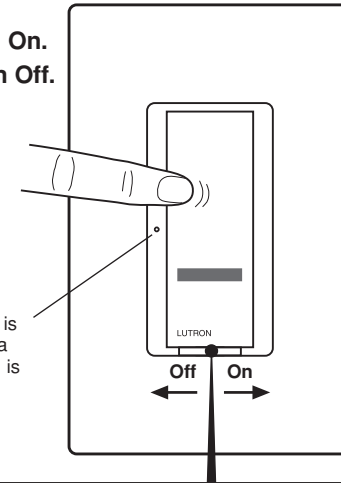

**LED** - Indicates light is ON or glows softly as a night light when switch is OFF.

**IMPORTANT NOTICE:**  
*FASS* - Front Accessible Service Switch - to replace bulb, power may be conveniently removed by sliding *FASS* switch to the left.  
For any procedure other than routine lamp replacement, power must be disconnected at the main electrical panel.

**Power Failure Memory** - Light(s) return to state prior to power failure.

## Important Wiring Information

When making wire connections, follow the recommended strip lengths and combinations for the supplied wire connectors. **Note:** Wire connectors provided are suitable for **copper wire only**. For aluminum wire, consult an electrician.

### Small:

Strip insulation 3/8" (10 mm) for 14 AWG wire  
Strip insulation 1/2" (13 mm) for 16 or 18 AWG wire  
Use to join one 14 AWG supply wire with one 16 or 18 AWG control wire.

### Large:

Strip insulation 1/2" (13 mm) for 10, 12 or 14 AWG wire  
Strip insulation 5/8" (16 mm) for 16 or 18 AWG wire  
Use to join one or two 12 or 14 AWG supply wires with one 10, 12, 14, 16, or 18 AWG control wire.



Twist wire connector tight.  
Be sure no bare wire is exposed.



**Step 4** Mount and align switch. Install *Claro* wallplate (sold separately).

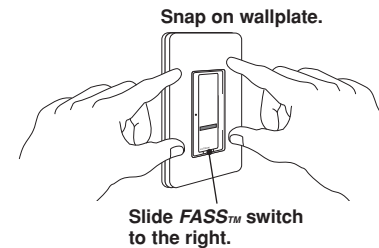
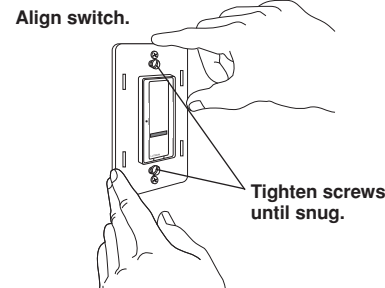

**Step 5** Turn power ON.

