

Description**Incandescent Dimmers** NT-Series

NT-600, NT-1000, NT-1500, NT-2000, NT-603P, NT-1003P, NT-1503P 120 V~ 60 Hz

These dimmers are for use with incandescent and halogen lamps only, 120 V~ 60 Hz. Do not connect to receptacles, fluorescent fixtures, motor-operated appliances, or transformer-supplied appliances.

Magnetic Low-Voltage Dimmers NTLV-Series

NTLV-600, NTLV-1000, NTLV-1500, NTLV-603P, NTLV-1003P, NTLV-1503P 120 V~ 60 Hz

NTLV-600-277, NTLV-1000-277 277 V~ 60 Hz

These dimmers are for use with magnetic low-voltage incandescent and halogen lamps only. Do not connect to receptacles, fluorescent fixtures, or motor-operated appliances. Use with core and coil (magnetic) low-voltage transformers. Do not use to control a solid-state electronic low-voltage transformer. Call the **Lutron Technical Support Center** for more information. Ask for Application Note 19: "Guide to Dimming Low-Voltage Lighting." Operation of a dimmed low-voltage circuit with all lamps removed or inoperative may result in current flow in excess of normal levels. To avoid possible transformer failure, Lutron strongly recommends the following:

- a. Do not operate dimmed low-voltage circuits without operative lamps in place.
- b. Replace burned-out bulbs immediately.
- c. Use transformers that incorporate thermal protection or fused transformer primary windings in order to prevent transformer failure caused by excess current.

Electronic Low-Voltage Dimmers NTELV-Series

NTELV-300, NTELV-600 120 V~ 60 Hz

These dimmers are for use with electronic transformer-supplied low-voltage lighting only. **Do not** connect to magnetic transformer-supplied low-voltage fixtures, receptacles, fluorescent fixtures, or motor-operated appliances. Some fixture manufacturers do not recommend dimming their solid-state transformers. To determine if a fixture may be dimmed, consult Lutron or the fixture manufacturer. These dimmers are overload-protected. If more than the rated load is applied, power to the circuit will shut off until the dimmer cools. If this happens, remove excess load from the circuit.

Fan-Speed Controls NTFS-Series

NTFS-6E, NTFS-12E 120 V~ 60 Hz

These controls are for use only with fan or blower units that are operated by shaded-pole or permanently-split capacitor motors. Use with other types of motors may damage equipment and void warranty. Use with fans marked "Suitable for use with solid-state fan-speed controls only." Set multi-speed fans to their highest setting before installing controls.

Incandescent Dimmers NT-Series
Magnetic Low-Voltage Dimmers NTLV-Series
Electronic Low-Voltage Dimmers NTELV-Series
Fan-Speed Controls NTFS-Series
Quiet Fan-Speed Controls NTFSQ-Series
Fluorescent Dimmers NTF-Series

Quiet Fan-Speed Controls**NTFSQ-Series**

NTFSQ 120 V~ 60 Hz

These controls are for use with a single ceiling paddle fan only, rated at 1.5 A maximum. (The current rating of your fan motor may be determined from the motor nameplate, packaging, or by contacting the manufacturer.) Do not wire into a circuit with a GFCI breaker or receptacle. Set multi-speed fans to their highest setting before installing controls. Do not use these controls for light fixtures. Not recommended for use with Hunter Original[®] Series fan; contact Lutron's Customer Service department for suitable controls.

Fluorescent Dimmers**NTF-Series**

NTF-10, NTFTU-5A 120 V~ 60 Hz

NTF-10-277 277 V~ 60 Hz

These dimmers are for use with Lutron's FDB, ECO, HL3, or CB3 Series Electronic Fluorescent Dimming Ballasts only. Refer to individual series specification sheets for maximum capacity. Do not use with other ballasts.

Important Notes**Please read before installing.**

1. Install in accordance with national and local electrical codes.
2. When no "grounding means" exist within the wallbox then the NEC[®] 2005, Article 404-9 allows a dimmer without a ground connections to be installed as a replacement, as long as a plastic, noncombustible wallplate is used. For this type of installation, cap or remove the green ground wire on the dimmer and use an appropriate wallplate such as Lutron's Nova T[®] series wallplates.
3. These controls are designed to operate in ambient temperatures from 0 °C to 40 °C (32 °F to 104 °F).
4. Strip wallbox wires. **Important:** When making wire connections, follow the recommended strip lengths and combinations for the supplied wire connectors. Twist wire connector tight making sure that no bare wire is exposed. **Note:** Wire connectors provided are suitable for copper wire only. For aluminum wire, consult an electrician.
5. Check for short circuits in new installations before wiring controls. With power OFF, use standard switch and connect to lamp and voltage line. Turn power ON. If breaker trips, a short is present. Correct wiring and check circuit again. Install control only when short is no longer present.
6. Multiphase applications: Use a separate neutral for each phase containing a control circuit. For more information, call the **Lutron Technical Support Center** and ask for Application Note 17, "Common Neutral Interaction."
7. To ensure proper dimming performance and full lamp life, fluorescent lamps must be operated at full intensity for 100 hours prior to dimming.

Cleaning Instructions

To clean, wipe with a clean damp cloth. **DO NOT** use any chemical cleaning solutions.



Wiring Diagrams

Model Number	Wiring Diagram
NT-600, NT-1000, NT-1500, NT-2000, NTFTU-5A	1
NT-603P, NT-1003P, NT-1503P	2
Single-Pole	3
3-Way	4
4-Way	4
NTLV-600, NTLV-1000, NTLV-1500	1
NTLV-600-277, NTLV-1000-277	7
NTLV-603P, NTLV-1003P, NTLV-1503P	2
Single-Pole	3
3-Way	4
4-Way	4
NTELV-300, NTELV-600	7
NTFS-6E, NTFS-12E	5
NTFSQ	1
NTF-10, NTF-10-277	6

Wiring Diagram 1

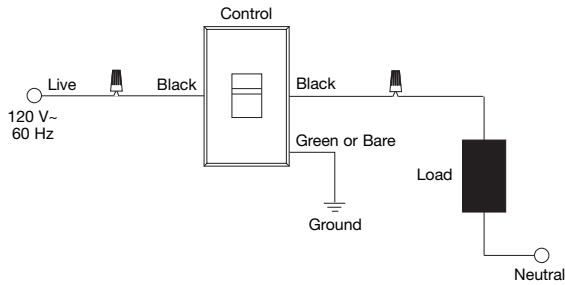

Wiring Diagram 2

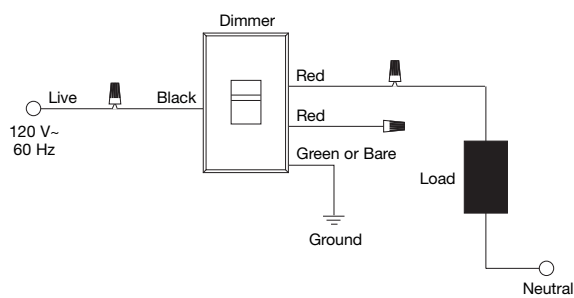

Wiring Diagram 3

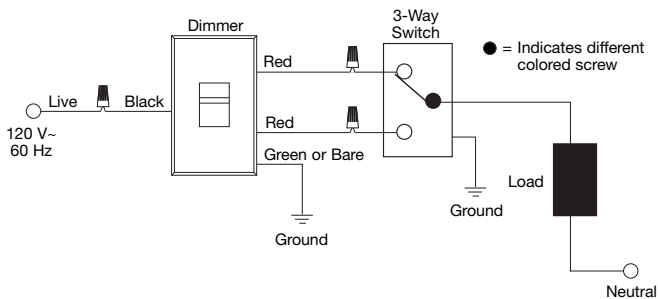

NOTE: Dimmers may be wired on either the line side or the load side of the switch.

Wiring Diagram 4

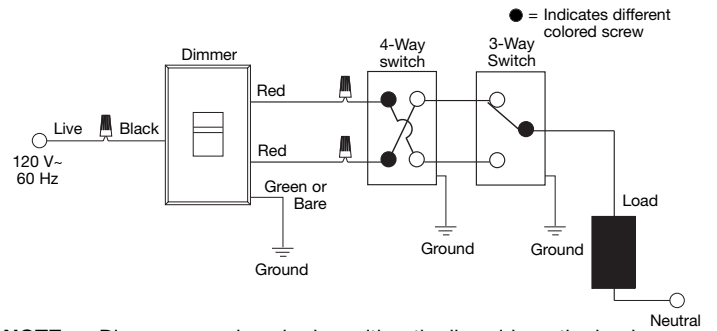

NOTE: Dimmers may be wired on either the line side or the load side of the switch(es).

Wiring Diagram 5

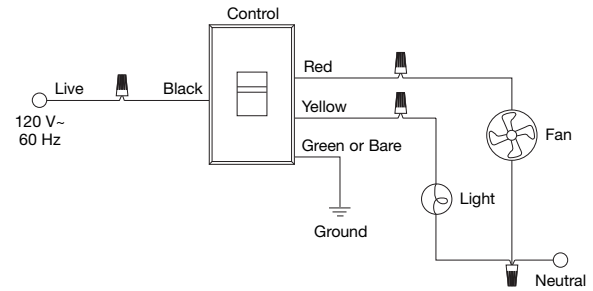

Wiring Diagram 6

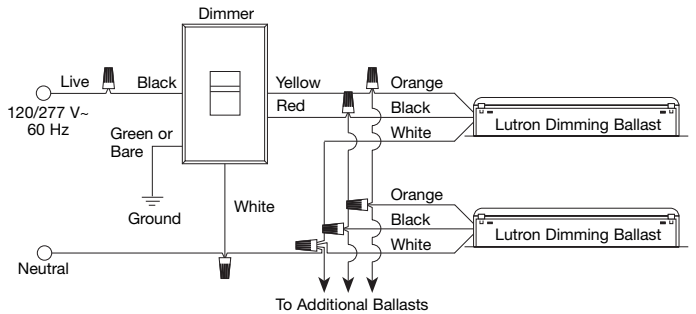

Wiring Diagram 7

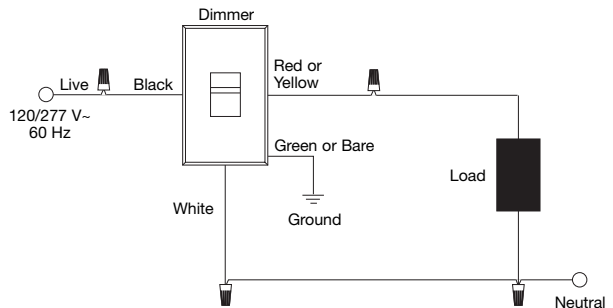

Installation

If more than one control is to be installed in the same wallbox, review the Multigang Installation section (back page) before beginning. Lutron multigang faceplates are available for ganging multiple units.

1. Turn power OFF at circuit breaker or remove fuse.
WARNING: Wiring with power on may result in personal injury. Damage to this product caused by wiring with power on voids warranty.
2. Remove faceplate and faceplate adapter from control to prevent damage and to access mounting holes. Pull from top of faceplate to remove. Unscrew faceplate adapter. Set aside.
3. Wire control per appropriate wiring diagram (see previous page) using wire connectors provided.
Note: Color names refer to the wire colors on the control.
4. Push wires into wallbox, allowing room for control to be inserted. Do not pinch wires between wallbox and control.
5. Mount control to wallbox using control mounting screws provided. Controls must be mounted vertically. See stamp on control for correct positioning.
6. Mount adapter plate with adapter mounting screws provided (see below).
7. Snap on slider and faceplate.
8. Turn power ON at circuit breaker or replace fuse.

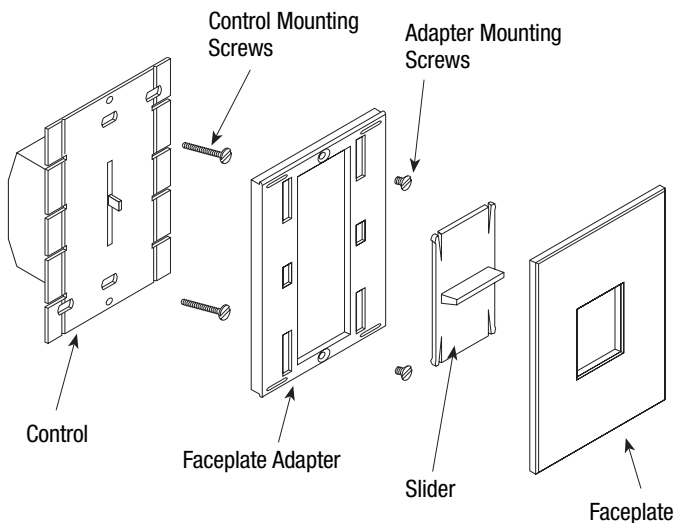

Operation

Slide-to-Off Controls

Raise slider to increase light intensity. Lower slider to decrease light intensity and turn off.

Preset Dimmers

Push button in center of slider to alternately turn lights on to preset level (set by slider) or turn lights off. Raise slider to increase light intensity. Lower slider to decrease light intensity.

3-Way and 4-Way Switches

When switching power from remote location, lights will turn on to level set on dimmer (by slider), or turn off. Move slider up or down to turn lights on or off.

Fluorescent Dimmers

Dimmers are factory calibrated and do not require low-end light adjustment. If lamps flicker or drop out at the minimum dimming level there may be an installation error. Continued use of the system in this mode will cause premature lamp failure. If this is occurring, call the **Lutron Technical Support Center** at: 1-800-523-9466.

To ensure proper dimming performance and full lamp life, fluorescent lamps must be operated at full intensity for 100 hours prior to dimming.

Multigang Installation

Multiple controls can be installed in a multigang wallbox or a series of interconnected wallboxes for a clean, consolidated appearance. Lutron multigang faceplates are available to complete the installation. Refer to instruction sheet supplied with multigang faceplates for installation.

For new installations, controls can be ganged without removing side sections, but, to reduce the size of the multigang installation or to fit existing wallboxes, inner side sections must be removed. Because side sections are designed to dissipate heat, removing them derates the capacity of the control.

Note: When ganging any combination of small and large controls, place all small controls on one end of the gang and all large controls on the other. Use the chart below to determine the size and rating of each control.

Control Size and Derating Chart

Model	Control Size	No Sides Removed	1 Side Removed	2 Sides Removed
NT-600	S	600 W	500 W	300 W
NT-1000	S	1000 W	900 W	700 W
NT-1500	L	1500 W	1250 W	1000 W
NT-2000*	L	1950 W	—	—
NTLV-600	S	600 VA	500 VA	300 VA
NTLV-600-277	S	600 VA	500 VA	300 VA
NTLV-1000	S	1000 VA	900 VA	700 VA
NTLV-1000-277	S	1000 VA	900 VA	700 VA
NTLV-1500	L	1500 VA	1250 VA	1000 VA
NT-603P	S	600 W	500 W	300 W
NT-1003P	S	1000 W	900 W	700 W
NT-1503P	L	1500 W	1250 W	1000 W
NTLV-603P	S	600 VA	500 VA	300 VA
NTLV-1003P	S	1000 VA	900 VA	700 VA
NTLV-1503P	L	1500 VA	1250 VA	1000 VA
NTELV-300	S	300 W	300 W	250 W
NTELV-600	S	600 W	500 W	400 W
NTFS-6E	S	6 A	4.2 A	2.5 A
NTFS-12E	L	12 A	10 A	8.3 A
NTFSQ	S	1.5 A	1.5 A	1.5 A
NTF-10	S	16 A	16 A	16 A
NTF-10-277	S	8 A	8 A	8 A
NTFTU-5A	S	5 A	4 A	3.3 A
NT-1PS	S	20 A	20 A	20 A
NT-3PS	S	20 A	20 A	20 A
NT-4PS	S	20 A	20 A	20 A

*NT-2000 cannot have side sections removed.

Note: The Wallbox Requirement Charts on this sheet do not apply for the NT-2000. See the NT-2000 instruction sheet for the appropriate requirements.

Worldwide Technical and Sales Assistance

If you have questions concerning the installation or operation of these products, call the **Lutron Technical Support Center**. Please provide exact model number when calling.

1-800-523-9466 (U.S.A., Canada, and the Caribbean)

Other Countries call +1-610-282-3800

Fax +1-610-282-3090

Visit our web site at www.lutron.com

Side Sections Removed (Derating Required)

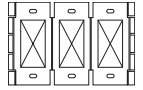

Wallbox Gang Size Requirement Chart

	Number of Small Controls							
	0	1	2	3	4	5	6	6
Number	0	1	2	3	4	5	6	6
of Large	1	3	4	5	6	7	8	8
Controls	2	3	5	6	7	8	9	10
	3	5	7	8	9	10	11	12
	4	7	9	10	11	12	13	14

Remove inner side sections from controls. Using pliers, bend side sections up and down until they break off.

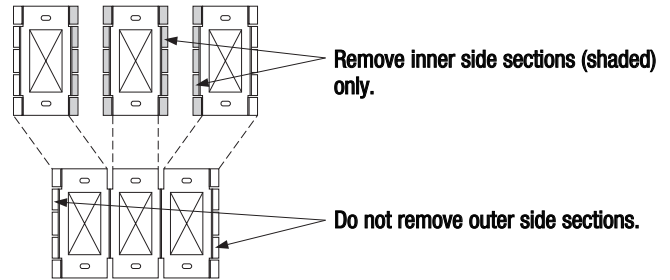

No Side Sections Removed (Derating Not Required)

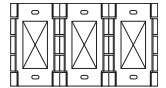

Wallbox Gang Size Requirement Chart

	Number of Small Controls				
	0	1	2	3	4
Number	0	1	1+1	4	4+1
of Large	1	3	5	6	8
Controls	2	4	6	7	9
	3	6	8	10	11
	4	9	11	12	14

Note: When ganging an even number of small controls with side sections intact, use gangable 3"x2" (76 mm x 51 mm) wallboxes. Space an additional wallbox 3/4" (19 mm) apart from the other wallboxes. A 3/4" (19 mm) chase nipple is recommended as a spacer between wallboxes.

Example: Wallbox arrangement required for ganging 4 small controls with no side sections removed:

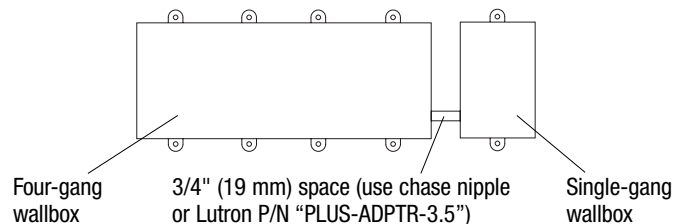

Limited Warranty

(Valid only in U.S.A., Canada, Puerto Rico, and the Caribbean.)

Lutron will, at its option, repair or replace any unit that is defective in materials or manufacture within one year after purchase. For warranty service, return unit to place of purchase or mail to Lutron at 7200 Suter Rd., Coopersburg, PA 18036-1299, postage pre-paid. **THIS WARRANTY IS IN LIEU OF ALL OTHER EXPRESS WARRANTIES, AND THE IMPLIED WARRANTY OF MERCHANTABILITY IS LIMITED TO ONE YEAR FROM PURCHASE. THIS WARRANTY DOES NOT COVER THE COST OF INSTALLATION, REMOVAL OR REINSTALLATION, OR DAMAGE RESULTING FROM MISUSE, ABUSE, OR DAMAGE FROM IMPROPER WIRING OR INSTALLATION. THIS WARRANTY DOES NOT COVER INCIDENTAL OR CONSEQUENTIAL DAMAGES. LUTRON'S LIABILITY ON ANY CLAIM FOR DAMAGES ARISING OUT OF OR IN CONNECTION WITH THE MANUFACTURE, SALE, INSTALLATION, DELIVERY, OR USE OF THE UNIT SHALL NEVER EXCEED THE PURCHASE PRICE OF THE UNIT.**

This warranty gives you specific legal rights, and you may have other rights which vary from state to state. Some states do not allow the exclusion or limitation of incidental or consequential damages, or limitation on how long an implied warranty may last, so the above limitations may not apply to you.

Lutron Electronics Co., Inc.

7200 Suter Road

Coopersburg, PA 18036-1299 U.S.A.

Made and printed in U.S.A. 9/06 P/N 030-772 Rev. B