

Description

Fluorescent Control

NTFTU-5A-277
CPW0091

This control is for use with *Advance[®] Mark X[®] Series Electronic Fluorescent Dimming Ballasts* only. Refer to the model numbers on the back page for maximum capacity. Do not use with other ballasts.

Important Notes

Please read before installing.

- CAUTION:** To avoid overheating and possible damage to other equipment, do not install to control receptacles, motor-operated appliances, or transformer supplied appliances.
- Install in accordance with national and local electrical codes.
- When no "grounding means" exist within the wallbox then the NEC[®] 2002, Article 404-9 allows a dimmer without a grounding connection to be installed as a replacement, as long as a plastic, noncombustible wallplate is used. For this type of installation, cap or remove the green ground wire on the dimmer and use an appropriate wallplate such as Lutron's Nova T[®] series wallplates.
- These controls are designed to operate in ambient temperatures from 0 °C to 40 °C (32 °F to 104 °F).
- Strip wallbox wires. **Important:** When making wire connections, follow the recommended strip lengths and combinations for the supplied wire connectors. Twist wire connector tight making sure that no bare wire is exposed. **Note:** Wire connectors provided are suitable for copper wire only. For aluminum wire, consult an electrician.

Small:

Strip insulation 3/8" (10 mm) for 14 AWG wire
Strip insulation 1/2" (13 mm) for 16 or 18 AWG wire
Use to join one 14 AWG supply wire with one 16 or 18 AWG control wire.

Large:

Strip insulation 1/2" (10 mm) for 10, 12 or 14 AWG wire
Strip insulation 5/8" (13 mm) for 16 or 18 AWG wire
Use to join one or two 12 or 14 AWG supply wires with one 10, 12, 14, 16, or 18 AWG control wire.

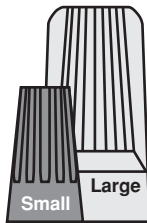

- Check for short circuits in new installations before wiring controls. With power OFF, use appropriate switch and connect to lamp and voltage line. Turn power ON. If breaker trips, a short is present. Correct wiring and check circuit again. Install control only when short is no longer present.
- Multiphase applications: Use a separate neutral for each phase containing a control circuit. For more information, call the **Lutron Technical Support Center** and ask for Application Note 17, "Common Neutral Interaction."
- To ensure proper dimming performance and full lamp life, fluorescent lamps must be operated at full intensity for 100 hours prior to dimming.
- Low-end Trim: Controls are factory calibrated to be used with *Advance Mark X* ballasts and should not require low-end light adjustment.

Cleaning Instructions

To clean, wipe with a clean damp cloth. **DO NOT** use any chemical cleaning solutions.

Wiring Diagram

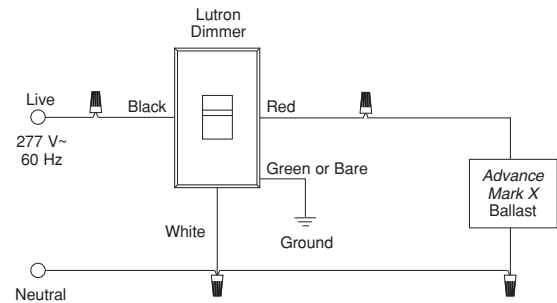

Installation

If more than one control is to be installed in the same wallbox, review the Multigang Installation section (back page) before beginning. Lutron multigang faceplates are available for ganging multiple units.

- Turn power OFF at circuit breaker or remove fuse.
WARNING: Wiring with power on may result in personal injury. Damage to this product caused by wiring with power on voids warranty.
- Remove faceplate and faceplate adapter from control to prevent damage and to access mounting holes. Pull from top of faceplate to remove. Unscrew faceplate adapter. Set aside.
- Wire Control per wiring diagram (see above) using wire connectors provided.
Note: Color names refer to the wire colors on the control.
- Push wires into wallbox, allowing room for control to be inserted. Do not pinch wires between wallbox and control.
- Mount control to wallbox using control mounting screws provided. Controls must be mounted vertically. See stamp on control for correct positioning.
- Mount adapter plate with adapter mounting screws provided (see below).
- Snap on slider and faceplate.
- Turn power ON at circuit breaker or replace fuse.

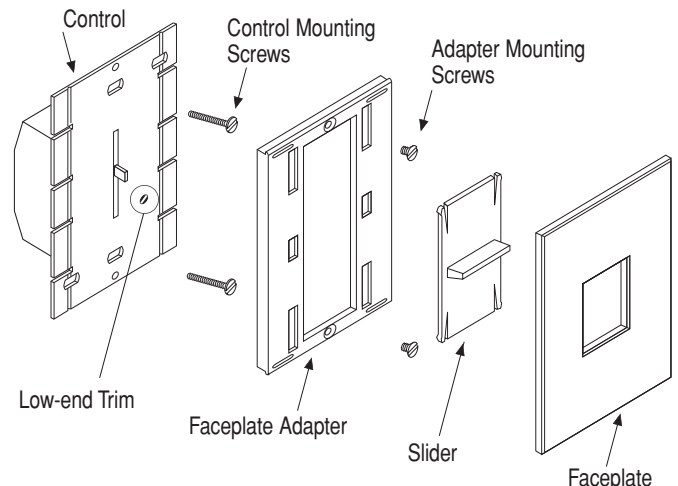

Operation

Slide-to-Off Controls

Raise slider to increase light intensity. Lower slider to decrease light intensity and turn off.

Multigang Installation

Multiple controls can be installed in a multigang wallbox or a series of interconnected wallboxes for a clean, consolidated appearance.

Lutron multigang faceplates are available to complete the installation. Refer to instruction sheet supplied with multigang faceplates for installation.

For new installations, controls can be ganged without removing side sections, but, to reduce the size of the multigang installation or to fit existing wallboxes, inner side sections must be removed. Because side sections are designed to dissipate heat, removing them derates the capacity of the control.

Note: When ganging any combination of small and large controls, place all small controls on one end of the gang and all large controls on the other. Use the chart below to determine the rating of each control.

Advance Mark X Model No.	Lamp	Maximum number of ballasts		
		No sides removed (5 Amps)	1 side removed (4 Amps)	2 sides removed (3.3 Amps)
VEZ-132	F25T8	45	36	30
VEZ-132	F32T8	38	30	25
VEZ-2S32	F25T8	22	18	15
VEZ-2S32	F32T8	19	15	12
VEZ-3S32	F25T8	15	12	10
VEZ-3S32	F32T8	13	10	8
VEZ-2Q26	26WQ-CFL	23	19	15
VEZ-1T32	26W-CFL	45	36	30
VEZ-1T32	32W-CFL	35	28	23
VEZ-1T42	42W-CFL	27	22	18
VEZ-2T42	42W-CFL	13	11	9
VEZ-154	54W-HO	21	17	14
VEZ-2S54	54W-HO	11	8	6
VEZ-1TTS40	T5-40W	33	26	22
VEZ-2TTS40	T5-40W	16	13	11

Technical Assistance



If you have questions concerning the installation or operation of this dimmer, call the **Lutron Technical Support Center**. Please provide exact model number when calling.



If you have questions concerning the installation or operation of the ballasts, call the **Advance Technical Support Center**.

Lutron

+1-800-523-9466 - U.S.A., Canada, and the Caribbean (24 hrs/7 days)

+1-610-282-3800 - Other countries (8am – 8pm ET)

Fax: +1-610-282-3090

<http://www.lutron.com>

Advance Transformer

+1-800-372-3331 - U.S.A. and Canada (7:30am – 4:30pm CT)

Fax: +1-847-768-7768

<http://www.advancetransformer.com>

Side Sections Removed

(Derating Required)

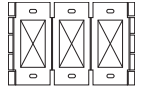

Wallbox Gang Size Requirement Chart

		Number of Small Controls						
		0	1	2	3	4	5	6
Number of Large Controls	0	0	1	2	3	4	5	6
	1	1	3	4	5	6	7	8
	2	3	5	6	7	8	9	10
	3	5	7	8	9	10	11	12
	4	7	9	10	11	12	13	14

Remove inner side sections from controls. Using pliers, bend side sections up and down until they break off.

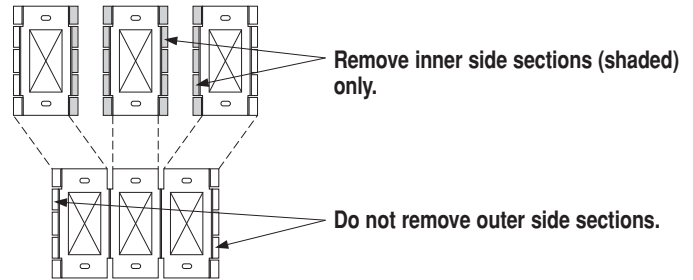

No Side Sections Removed

(Derating Not Required)

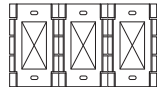

Wallbox Gang Size Requirement Chart

		Number of Small Controls						
		0	1	2	3	4	5	6
Number of Large Controls	0	0	1	1+1	4	4+1	7	7+1
	1	1	3	5	6	8	9	11
	2	4	6	7	9	10	12	13
	3	6	8	10	11	13	14	16
	4	9	11	12	14	15	17	18

Note: When ganging an even number of small controls with side sections intact, use gangable 3"x2" (76 mm x 51 mm) wallboxes. Space an additional wallbox 3/4" (19 mm) apart from the other wallboxes. A 3/4" (19 mm) chase nipple is recommended as a spacer between wallboxes.

Example: Wallbox arrangement required for ganging 4 small controls with no side sections removed:

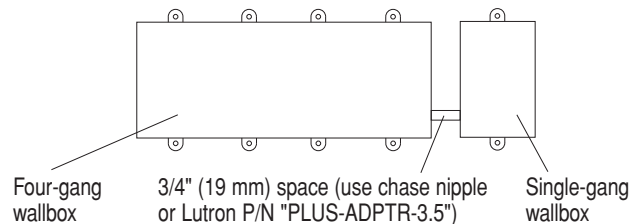

Limited Warranty

(Valid only in U.S.A., Canada, Puerto Rico, and the Caribbean.)

Lutron will, at its option, repair or replace any unit that is defective in materials or manufacture within one year after purchase. For warranty service, return unit to place of purchase or mail to Lutron at 7200 Suter Rd., Coopersburg, PA 18036-1299, postage pre-paid.

THIS WARRANTY IS IN LIEU OF ALL OTHER EXPRESS WARRANTIES, AND THE IMPLIED WARRANTY OF MERCHANTABILITY IS LIMITED TO ONE YEAR FROM PURCHASE. THIS WARRANTY DOES NOT COVER THE COST OF INSTALLATION, REMOVAL OR REINSTALLATION, OR DAMAGE RESULTING FROM MISUSE, ABUSE, OR DAMAGE FROM IMPROPER WIRING OR INSTALLATION. THIS WARRANTY DOES NOT COVER INCIDENTAL OR CONSEQUENTIAL DAMAGES. LUTRON'S LIABILITY ON ANY CLAIM FOR DAMAGES ARISING OUT OF OR IN CONNECTION WITH THE MANUFACTURE, SALE, INSTALLATION, DELIVERY, OR USE OF THE UNIT SHALL NEVER EXCEED THE PURCHASE PRICE OF THE UNIT.

This warranty gives you specific legal rights, and you may have other rights which vary from state to state. Some states do not allow the exclusion or limitation of incidental or consequential damages, or limitation on how long an implied warranty may last, so the above limitations may not apply to you.

Lutron Electronics Co., Inc.

7200 Suter Road

Coopersburg, PA 18036-1299 U.S.A.

Made and printed in U.S.A. 1/06 P/N 030-870 Rev. B