

GRAFIK Eye® 3000 Series Installer's Guide

Models 3100 and 3500

PLEASE LEAVE FOR OCCUPANT



GRAFIK Eye 3000 Series Control Units

supply power to, and control the brightness of two, three, four, or six zones of lighting. GRAFIK Eye Control Units control the intensity of all the light sources in a room. You can adjust the lights for a special event or activity with the press of a button!

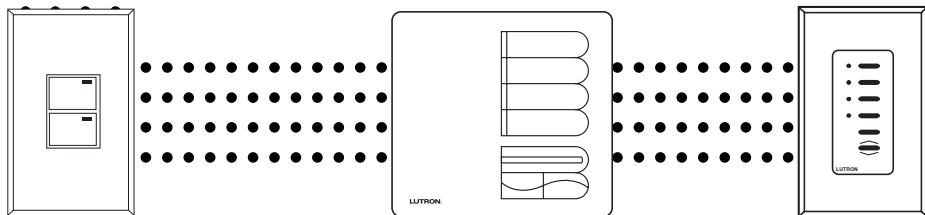

IMPORTANT! GRAFIK Eye lighting controls must be installed by a qualified electrician in accordance with all applicable regulations. Improper wiring can result in personal injury or damage to GRAFIK Eye lighting controls or other equipment. Always turn off circuit breaker/MCB or remove main fuse from power line before doing any work. To avoid overheating and possible damage to equipment, do not install dimming devices to dim receptacles, motor-operated appliances, or fluorescent lighting not equipped with Lutron Hi-lume®, Eco-10™, or Tu-Wire™ Electronic Dimming Ballasts. In dimmed magnetic low-voltage circuits, you can prevent transformer overheating and failure by avoiding excessively high current flow: Do not operate GRAFIK Eye lighting controls with any lamps removed or burned out; Replace any burned out lamps immediately; Use only transformers that incorporate thermal protection or fused primary windings. This lighting control is designed for residential and commercial use. GRAFIK Eye Controls are designed for indoor use only.

Do you have:	Then read this on page:
Control Unit only? Follow Step 1 and Step 3	STEP 1: Installing 3000 Series Control Units How to wire and mount GRAFIK Eye 3000 Series Control Units.	3
Wallstations too?	STEP 2: Installing Wallstations DIP switch address settings, wiring, and mounting.	4
	STEP 3: Setting Up Control Units Identifying load types and setting up lighting scenes.	6
	STEP 4: Setting Up System Communications Assigning Wallstations to the Control Units they should operate.	10
Questions about Class 2/PELV wiring?	Appendix A: More about Class 2/PELV Wiring	12
	Appendix B: Special Mounting Considerations	14
	Appendix C: Power Boosters, Electronic Low Voltage Interfaces, and Fluorescent Dimming Ballast Interfaces	14
	Appendix D: GRX-TVI 0-10 Volt Ballast Interface	15
	Appendix E: HP 2•4•6 Dimming Modules	17
	Appendix F: Infrared Controls	18
Problems?	Appendix G: Troubleshooting	18

Questions? Need technical assistance?

Phone Assistance . . . Worldwide!

- **In the U.S., Canada and the Caribbean:**
1-800-523-9466
- **In Mexico, Central and South America:**
1-610-282-3800
- **In Japan:** 03-5405-7333
- **In Hong Kong:** 2104-7733
- **In the U.K.:** 0800-282-107
- **In Europe:** 44-171-702-0657
- **All others:** 1-610-282-3800
- **Website address:** www.lutron.com
- **E-mail:** product@lutron.com

Warranty

Lutron warrants each new unit to be free from defects in materials and workmanship and to perform under normal use and service. This warranty shall run only for a period of one year from the date of purchase and Lutron's obligations under this warranty are limited to remedying any defect or replacing any defective part and shall be effective only if the defective unit is shipped to Lutron postage prepaid within 12 months after purchase. Damage due to abuse, misuse, inadequate wiring or installation is not covered by this warranty. In no event shall Lutron or any other seller be liable for any other loss or damage, including consequential or special damages that may arise through the use by a purchaser or others of this device and the purchaser assumes and will hold harmless Lutron in respect of all such loss. Although every attempt is made to ensure that catalogue information is accurate and up-to-date, please check with Lutron before specifying or purchasing this equipment to confirm availability, exact specifications and suitability for your application. This product may be covered by one or more of the following U.S. patents: 4,797,599; 4,803,380; 4,825,075; 4,893,062; 5,030,893; 5,191,265; 5,430,356; 5,463,286; 5,530,322; 5,808,417; DES 308,647; DES 310,349; DES 311,170; DES 311,371; DES 311,382; DES 311,485; DES 311,678; DES 313,738; DES 335,867; DES 344,264; DES 370,663; DES 378,814 and corresponding foreign patents. U.S. and foreign patents pending. Lutron, GRAFIK Eye, and Hi-Lume are registered trademarks; Hi-Power, Eco-10, LIAISON, Designer, Tu-Wire, and Architrave are trademarks of Lutron Electronics Co., Inc. © 1999 Lutron Electronics Co., Inc.



Safety standards listed above apply to one or more products in the GRAFIK Eye product line. Consult factory for specific information.

STEP 1: Installing Control Units

This section shows how to install Control Units and make sure they are properly operating all connected loads.

CAUTION!

First test loads for short circuits.

1. Turn power OFF at the breaker/MCB panel or fuse box.
2. Connect standard light switch between live lead and the load wire to test circuit.
3. Turn power on and check for short or open circuits: If load does not operate, circuit is open. If the breaker/MCB trips (fuse blows or opens), circuit is shorted. Correct short or open circuits and test again.

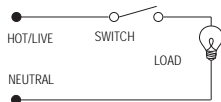

Load Types

The Control Units can control incandescent, halogen (tungsten), magnetic low-voltage, and neon/cold cathode load types. Electronic low-voltage and fluorescent load types can be controlled with an appropriate interface.

- Not all zones need to be connected; however, connected zones must have a load of at least 25W (40W for AU and CE models).
- No zone may be loaded with more than 800 W (1200 for AU models).
- Unit must not carry more than 16A of total lighting load (10A for CE models).
- All Electronic Low-Voltage (ELV) lighting used with the Electronic Low-Voltage Interface must be rated for **reverse phase-control dimming**. Before installing an ELV light source, verify with the manufacturer that their transformer can be dimmed. When dimming, an Electronic Low-Voltage Interface **MUST** be used with the Series Control Unit.

Installation instructions. First, turn power off.

Preparation

1. **Mount Wallbox.** Use standard U.S. wallbox, 3 1/2 in. (87 mm) deep is strongly recommended, 2 3/4 in. (68 mm) deep minimum. Always allow at least 4 1/2 in. (110 mm) clearance above and below the faceplate to ensure proper heat dissipation.
2. **Pull Wires.** Use the rearmost knockouts when pulling wires into the wallbox. This will provide the most clearance when mounting the Control Unit.
3. **Remove Cover.** Remove the Control Unit's cover and hinged faceplate by pulling outward at each corner.

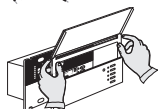
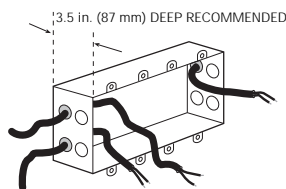

<u>Model Number</u>	<u>Wallbox Size/Max. Unit Load</u>		
	<u>100-127V</u>	<u>230V</u>	<u>220-240V</u>
3102/3502	2-Gang U.S./1200W/VA	4-Gang U.S./10A	2-Gang U.S./1600W/VA
3103/3503	3-Gang U.S./1500W/VA	4-Gang U.S./10A	3-Gang U.S./2400W/VA
3104/3504	4-Gang U.S./2000W/VA	4-Gang U.S./10A	4-Gang U.S./3000W/VA
3106/3506	4-Gang U.S./2000W/VA	4-Gang U.S./10A	4-Gang U.S./300W/VA

† Lutron P/N 241-400.

Line Voltage/Mains Wiring

IMPORTANT WIRING NOTES!

- Use properly certified cable for all line voltage/mains cables and Class 2/PELV cables.
- In Europe, acceptable types of cable include HAR certified cable with insulated cores enclosed in a sheath. This cable must bear the appropriate certification mark pertaining to national wiring rules for fixed installations. If certified cable with insulated cores enclosed in a sheath is used for the Power cables, the Class 2/PELV wiring can be any of the specified cables in **Appendix A: More about Class 2/PELV Wiring**.
- Proper short-circuit and overload protection must be provided at the distribution panel. You can use up to a 20A (16A for AU, and 10A for CE models) maximum circuit breaker/MCB or equivalent (tripping curve C according to IEC60898/EN60898 is recommended) with adequate short-circuit breaking capacity for your installation.
- Install in accordance with all local and national electrical codes.
- **CAUTION!** Do not connect line voltage/mains cable to Class 2/PELV terminals.
- Earth/Ground terminal connection must be made as shown in wiring diagrams.

- Do not mix different load types on the same zone!
- Fluorescent and electronic low voltage loads require interfaces. Zone loads that exceed 800W/VA (1200W/VA for AU models) and total unit loads that exceed the unit capacity require power boosters. Refer to Appendices C, D, E, and F.

Wire the Control Unit (see Page 16)

1. Strip 1/2 in. (12 mm) insulation from all wires in wallbox and connect them to appropriate terminals on the back of the Control Units. The recommended installation torque is 9.0 in.•lbs. (1.0 N•m) for line voltage connections and 10 in.•lbs. (1.3 N•m) for the earth/ground connection. Each power terminal can accept up to two #12 AWG (2.5 mm²) wires. (Does not apply to Class 2/PELV terminal block.)

Class 2/PELV Wiring

Connect Class 2/PELV wiring *only* if your project has Wallstations and/or more than one Control Unit.

Use recommended cable as specified in **Appendix A: More About Class 2/PELV Wiring**.

Wiring Note

- Use the rearmost knockouts when pulling wires into the wallbox. This will provide the most clearance when mounting the Control Unit.
1. Strip 1 in. (25 mm) of insulation from the Class 2/PELV cable.
 2. Strip 3/8 in. (8 mm) of insulation from each wire.
 3. **Connect the Class2/PELV wires to the Class 2/PELV terminal block.** Make sure no bare wire is exposed after making connections. The recommended installation torque is 3.5 in. • lbs. (0.4 N • m) for Class 2/PELV connections.
 4. The Class 2/PELV cable and terminal block should be separated from line voltage/mains cables by at least 1/4 in. (7 mm).

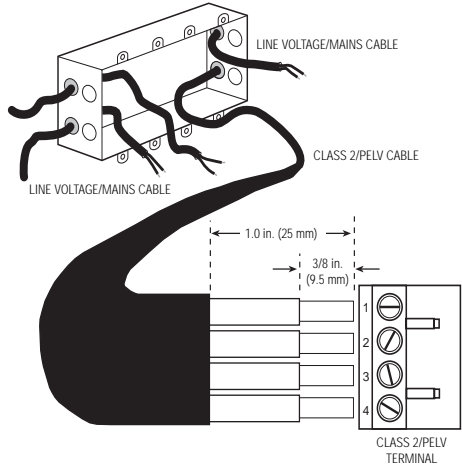

Mounting

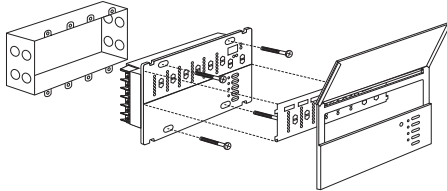

1. Mount as shown using the four screws provided. (When mounted in the wallbox, the Class 2/PELV cable and terminal block should remain separated from the line voltage/mains cables.)
2. Reattach the faceplate to the Control Unit by pushing inward at each corner.

Testing: Do the lights work?

1. **Restore Power.**
2. **Press Scene 1 button** on front of the GRAFIK Eye Control Unit. The Scene 1 LED will light.
3. **Press zone ▲ or ▼** to raise or lower the light levels. Make sure that the Control Unit is dimming all connected loads. Refer to **Appendix G: Troubleshooting**, or call Lutron.

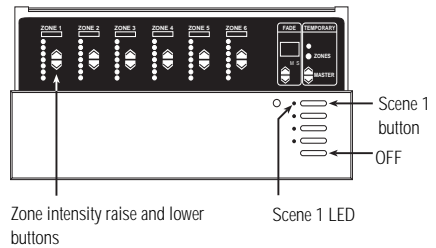

STEP 2: Installing Wallstations

IMPORTANT WIRING NOTES!

Review Appendix A BEFORE wiring!

- Wallstations must be installed by a qualified electrician.
- Wallstations use Class 2 or PELV wiring methods as applicable in your locale.
 - **Using Class 2 wiring methods:** Wallstations must be connected in accordance with the 1996 National Electrical Code, Article 725-54(a), (1) Exception No. 3 or the Canadian 1994 CE Code Handbook, Rule 16-212, Subrule (4). Check with your local electrical inspector to comply with local codes and wiring practices.
 - **Using PELV wiring methods:** Wallstations that are connected to terminals 1—4 must always meet the requirements of DIN VDE 0100 Part 410 and IEC 60364-4-41 for PELV circuits. See "What is PELV?" in Appendix A.
- Wallstations must be mounted in a wallbox. Please refer to instruction sheet included with each Wallstation to determine wallbox requirements.
- Note that the NTGRX-1S can use line voltage/mains branch circuit wiring. Refer to the installation instructions packaged with the Wallstation.

Examples of Wallstations

NTGRX-2B-SL	Entrance/Special Function Control
NTGRX-4S	Scene Selection Control with Raise/Lower
NTGRX-4S-IR	Scene Selection Control/Infrared Receiver
NTGRX-4B	Scene Selection Control
NTGRX-4M	Master Control
NTGRX-4PS	Partition Control
GRX-CIR*	Infrared Ceiling Receiver
GRX-4S-DW*	Architrave™ Door Jamb Control
GRX-AV*	Interface Control
GRX-RS232*	RS-232 Interface Control
GRX-PRG*	Personal Computer Interface
GRX-IT/GRX-8IT	Infrared Handheld Transmitter (see Appendix C)
EGRX-4S*	European Style 4S Control
EGRX-4S-IR*	European Style 4S Control/Infrared Receiver

... and more!

Set DIP switches 1—4 with unique system address

Each Wallstation must have a *unique* system address (1—16) to identify the Wallstation and enable it to communicate with the Control Unit(s).

To set its address, set DIP switches 1—4 to one of the configurations shown at right (GRX-PRG automatically assumes address 16). Document your assignments by noting each Wallstation's address.

DIP SWITCHES 1—4
SET ADDRESS

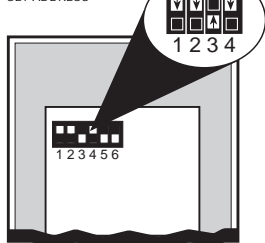

FOR THIS ADDRESS . . .

	SET SWITCHES LIKE THIS:	RECORD LOCATION AND TYPE OF CONTROL HERE	SET SWITCHES LIKE THIS:	RECORD LOCATION AND TYPE OF CONTROL HERE
1	1: ↑, 2: ↑, 3: ↑, 4: ↑	_____	9	9: ↓, 10: ↓, 11: ↓, 12: ↓
2	1: ↓, 2: ↑, 3: ↑, 4: ↓	_____	10	10: ↓, 11: ↓, 12: ↓, 13: ↓
3	1: ↓, 2: ↓, 3: ↓, 4: ↓	_____	11	11: ↓, 12: ↓, 13: ↓, 14: ↓
4	1: ↓, 2: ↓, 3: ↓, 4: ↑	_____	12	12: ↓, 13: ↓, 14: ↓, 15: ↓
5	1: ↓, 2: ↓, 3: ↓, 4: ↓	_____	13	13: ↓, 14: ↓, 15: ↓, 16: ↓
6	1: ↓, 2: ↓, 3: ↓, 4: ↓	_____	14	14: ↓, 15: ↓, 16: ↓, 17: ↓
7	1: ↓, 2: ↓, 3: ↓, 4: ↓	_____	15	15: ↓, 16: ↓, 17: ↓, 18: ↓
8	1: ↓, 2: ↓, 3: ↓, 4: ↓	_____	16*	16: ↓, 17: ↓, 18: ↓, 19: ↓

* Reserved for GRX-PRG, if present on link.

Set DIP switches 5, 6 and/or 7 to specify function

For most Wallstations, you must also set DIP switches to specify exactly how the Wallstation is to function. Please refer to the Instructions shipped with each Wallstation for more detailed information.

NTGRX-4S, -4S-DW, -4S-IR, -CIR, -4B

Scene Selection Control

Switches 5 and 6 determine which scenes the unit will select:



NTGRX-4M

Master Control

Switches 5 and 6 determine whether bottom button turns lights on or off:



NTGRX-2B-SL

Multi-Control

Switches 5, 6 and 7 determine the function of the unit's two buttons:

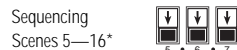
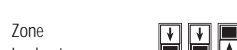
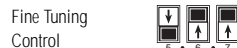

* When using a Wallstation to access scenes 5—16, the scene LEDs will illuminate only on the Wallstation—not on the GRAFIK Eye Control Unit.

Turn off power and wire

Review **Appendix A: More About Class 2/PELV Wiring** before proceeding!

1. Mount 1-gang U.S. wallbox*, 2 3/4 in. deep (68 mm) **minimum**.
2. Strip 3/8 in. (9 mm) insulation from both twisted pairs in the wallbox.
3. Connect two #18 AWG (1.0 mm²) twisted pairs for Class 2/PELV wiring (daisy-chain between stations)†.
4. Confirm all connections.

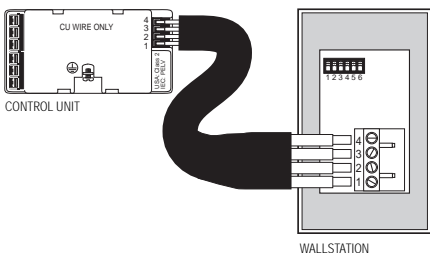

Mounting

Place twisted pairs in wallbox and mount as shown. Restore power.

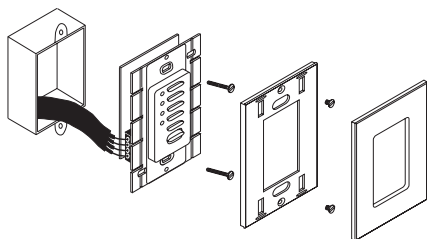

* Some Wallstations have special mounting considerations. Please refer to the detailed instructions supplied with each Wallstation.

† If shielded wire is used, the drain wire must also be daisy-chained. **Do not** connect drain wire to earth/ground or Wallstation (unless a "D" terminal is present).

STEP 3: Setting Up GRAFIK Eye Control Units

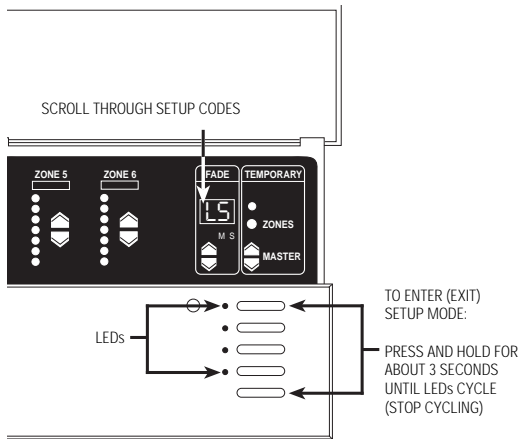

This section shows how to set up a GRAFIK Eye Control Unit, including:

- Identifying the load type for each zone of lighting connected to the Control Unit.
- Setting up the scenes to create the desired lighting effects, and make sure the Control Unit is working correctly.

To set up the GRAFIK Eye Control Unit, enter the "setup mode" and use the menu of setup codes that appear in the FADE window. Step-by-step instructions for using the setup codes are on the following pages.

How to enter and exit setup mode

To enter setup mode: Press and hold the Scene 1 and OFF button for about three seconds, until the scene LEDs start cycling.

To exit setup mode: Exit setup mode the same way you entered it. Press and hold the Scene 1 and OFF button for about 3 seconds, until scene LEDs stop cycling. The Control Unit is out of setup mode; back in normal operating mode.

In setup mode, the FADE window displays the setup codes. To scroll through the menu of setup codes, press the FADE ▲ or ▼ buttons.

The following is a list of the setup codes and their descriptions:

Code	Stands for	Description
Sd	Save Options	Select from several save options (p. 9)
Sc	Scene	Set unaffected zones and set any of the 16 scenes (p. 9)
R-	Address	Identify Control Units when setting up system communications (p. 10)
LS*	Load Select	Identify load type (p. 7)
LE	Low End	Set low end trim (p. 8)

*When you enter setup mode, this code appears first.

- If you press FADE ▲, you will see R-, Sc, then Sd.
- If you press FADE ▼, you will see LE.

Identifying the load type for each zone

Lutron ships GRAFIK Eye Control Units with all zones set for incandescent/halogen (tungsten) lighting. If your project has non-incandescent loads, change all non-incandescent zones to the correct load type.

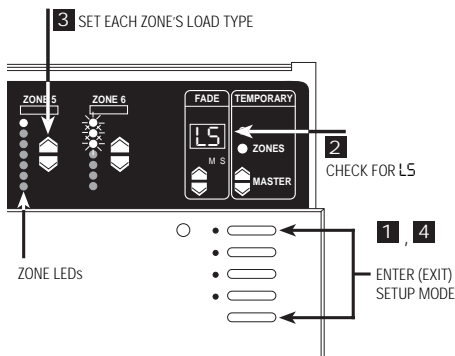

- 1. Enter setup mode.** Press and hold Scene 1 and OFF buttons for about 3 seconds, until scene LEDs cycle.
- 2. Check for LS in FADE window.** (LS is the first code to appear when you enter setup mode. For the LS mode, ZONE LEDs turn on from top to bottom.)
- 3. Set each zone's load type.** Press ZONE ▲ and ▼ until ZONE LEDs match the load type connected to each zone. Refer to chart on next page.
- 4. Exit setup mode.** Press and hold Scene 1 and OFF buttons for about 3 seconds, until scene LEDs stop cycling.

In the 6-Zone Control Unit shown here:

- Zone 5 is set for incandescent or magnetic low-voltage.
- Zone 6 is set for neon/cold cathode.

FOR THIS LOAD TYPE...	INCANDESCENT, HALOGEN (TUNGSTEN)	MAGNETIC LOW VOLTAGE	HP 2•4•6 LOADS* (120V SUPPLY ONLY)	ELECTRONIC LOW VOLTAGE*	Hi-lume® OR Eco-10™ FLUORESCENT*	TU-WIRE™ COMPACT FLUORESCENT*	NEON/COLD CATHODE	NON-DIM* (LAST ON, FIRST OFF)	NON-DIM* (FIRST ON, FIRST OFF)
-----------------------	----------------------------------	----------------------	------------------------------------	-------------------------	----------------------------------	-------------------------------	-------------------	-------------------------------	--------------------------------

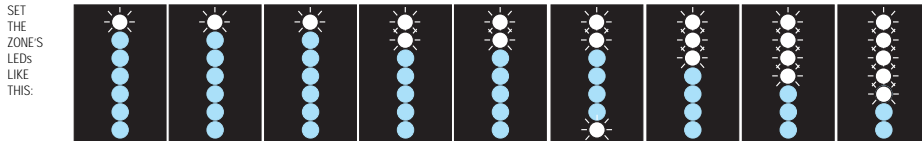

- Set all zones connected to HP 2•4•6 Dimming Modules as shown—no matter what load type they are (including non-dim or switching). The HP 2•4•6 can be used to switch non-capacitive ballasts. To fine-tune the dimming of these “HP-powered” zones, you must adjust high- and low-end trim on the HP 2•4•6 Dimming Module as described in the Instruction Sheet supplied with the unit. Do **NOT** use HP 2•4•6 Dimming Modules with generator-supplied line/mains voltage.
- All electronic low-voltage (ELV) lighting used with the Electronic Low-Voltage Interface (ELVI) must be rated for reverse phase control dimming. Before installing an ELV light source, verify with the manufacturer that their transformer can be dimmed. When dimming, an ELVI **MUST** be used with the 3000 Series Control Unit.
- Any zones set for Lutron Hi-lume or Eco-10 fluorescent lighting **must** have GRX-FDBI or GRX-TVI Fluorescent Interfaces. Consult Lutron for more information.
- Please note that the Tu-Wire Compact Fluorescent, unlike other fluorescent load types, **does not** require an FDBI interface. This load type is not available in GRX-CE models.
- Use non-dim for any lights to be switched on and off only—not dimmed (unless using HP Dimming Module).
 - Fluorescent non-dim loads with electronic or magnetic ballasts must: use a GRX-TVI Interface *and* be set for non-dim mode, or use an HP 2•4•6 *and* be set for HP 2•4•6 loads.

What is a scene?

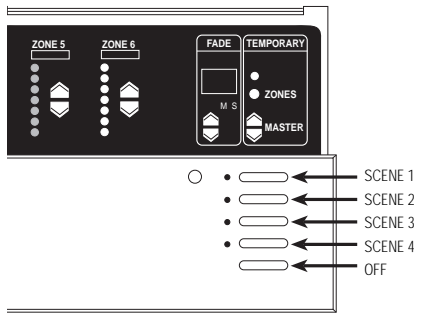

Scenes are the preset light levels and fade times stored in the Control Unit. To create a scene, set the appropriate intensity for each ZONE. To recall a scene, simply press one of the buttons. The first button calls up Scene 1; the second, Scene 2; and so on. The last button turns lights Off. For example, typical scene settings for a living room might be:

SCENE	ACTIVITY OR EVENT	LIGHT LEVELS FOR ZONES			
		Cove Lights	Hanging Lights	Down Lights	Scenes
1	General use	70%	10%	20%	20%
2	Entertaining	80%	25%	90%	40%
3	Reading	10%	60%	40%	0%
4	TV	20%	0%	30%	20%

Scenes 1—4 can be selected on the Control Unit. However, all Control Units are capable of storing up to 16 scenes. Scenes 5 through 16 can be selected using Wallstations.

How to set up lighting scenes

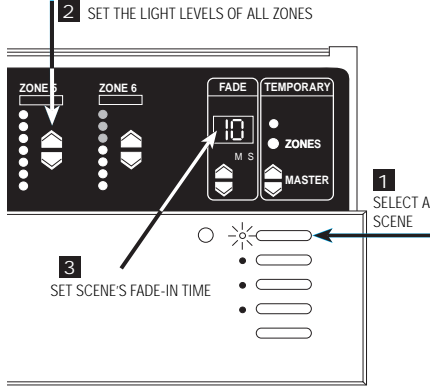

Note: Control Unit must be in Sd mode. See page 9 for more information regarding Save Options.

- To set up scenes 1 through 4:
- Select a scene.** Press the Scene button for the scene you want to adjust. (First button for Scene 1, second button for Scene 2, and so on.) Note that the last button is the “Off” Scene. You do not set intensities for this button.
 - Set each zone’s light levels.** Press ZONE ▲ and ▲ to adjust each ZONE to the right visual intensity for this scene. (ZONE LEDs show intensity bargraph-style. Each LED represents ~ 15% intensity change. In this example, ZONE 6 is set to 60%.) To program scenes 5 through 16, or for more precise zone intensity adjustment with a GRAFIK Eye 3500 Control Unit, refer to page 8.
 - Set scene’s FADE-in time.** Press FADE ▲ and ▲ to make FADE-in time anything from 0—59 seconds or 1—60 minutes*. (A scene’s FADE-in time is how long it takes light intensities to adjust to their new levels when the scene is selected.)

* The S and M indicators under the FADE window show whether FADE is “M”inutes or “S”econds. To set FADE in minutes, you press FADE ▲ to scroll through 1—59 seconds . . . the M lights. FADE is now expressed in minutes. To get back to seconds, press FADE ▼ until the window shows “S”econds.

Repeat this process to set up each of the remaining scenes. Note that you can also set up a “FADE-to-off” time. Press the OFF button and adjust FADE as desired.

How to adjust light levels temporarily

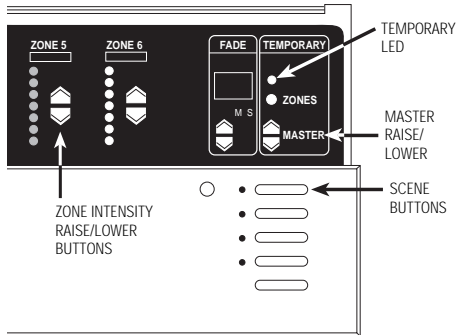

Control Unit must be in either 5d or 5b mode. See page 9 for more information regarding Save Options.

To adjust an entire scene:

Press the appropriate scene button.

Press MASTER ▲ or ▼ to raise or lower the intensity of all zones.

To adjust a zone:

If the TEMPORARY LED is not already lit, press the TEMPORARY ZONES button. The TEMPORARY LED above the TEMPORARY ZONES button will light.

Press ZONE ▲ or ▼ to adjust any zone's intensity.

Note: These adjustments are temporary and remain only until a new scene selection occurs—the GRAFIK Eye Control Unit does not store them as permanent scene settings.

How to set low-end trim—OPTIONAL

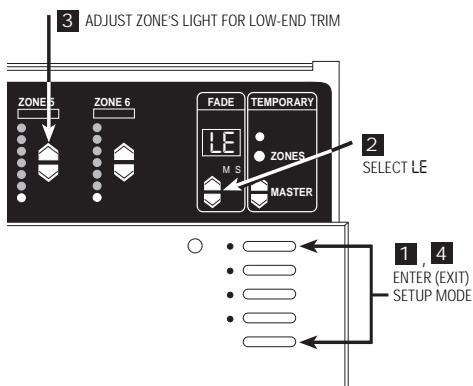

If necessary, adjust the low-end trim to achieve uniform low-intensity dimming and to eliminate flicker (especially with neon/cold-cathode and fluorescent loads).

- 1. Enter setup mode.** Press and hold Scene 1 and OFF buttons for about 3 seconds, until scene LEDs start cycling.
- 2. Select LE** (for low end) by pressing FADE ▼ once. All zones go to their lowest possible dim levels and only their bottom LED is lit*.
- 3. Adjust zone's lights for low-end trim.** Use ZONE ▼ and ▲ to dim the zone's lights as much as possible without causing flicker. This setting becomes the "optimum lowest level" to which the zone will dim before going off. Repeat this process for any other zones that require low-end trim.
- 4. Exit setup mode.** Press and hold Scene 1 and OFF buttons until scene LEDs stop cycling.

Note: The ZONE LED bargraph does not change while you make low-end trim adjustments. The bargraph remains set to its lowest level in this mode.

* Except zones set for non-dim. For these, all zone LEDs are lit, and you cannot adjust the low-end trim.

Advanced Scene Programming Options—OPTIONAL

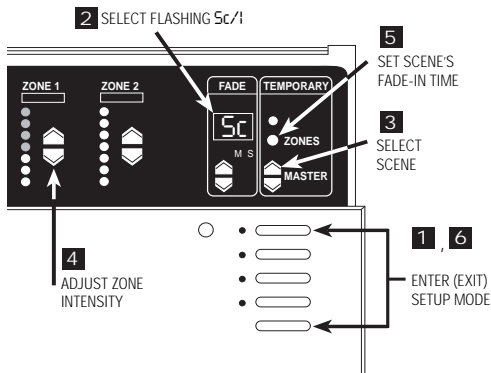

Programming Scenes 5 through 16.

- 1. Enter setup mode.** Press and hold Scene 1 and OFF buttons about 3 seconds until scene LEDs start cycling.
- 2. Select 5c** (the code for scene setup) by pressing FADE twice. 5c and 1 (for Scene 1) will alternately flash in the FADE window.
- 3. Select scene.** Press MASTER ▲ or ▼ to select the scene to be programmed.
- 4. Adjust ZONE-intensity.**
 - 3100** - Press ZONE ▲ or ▼ to adjust zone's intensity.
 - 3500** - Press ZONE ▲ or ▼ to display exact percentage light output. Press again to adjust light levels in 1% increments.
- 5. Set scene's FADE-in time.** Press and hold the TEMPORARY ZONES button. The current FADE-in time is displayed. Adjust using the FADE ▲ and ▼ while still holding the TEMPORARY ZONES button.
- 6. Exit setup mode.** Press and hold Scene 1 and OFF buttons until LEDs stop cycling.

How to set an “unaffected zone” — OPTIONAL

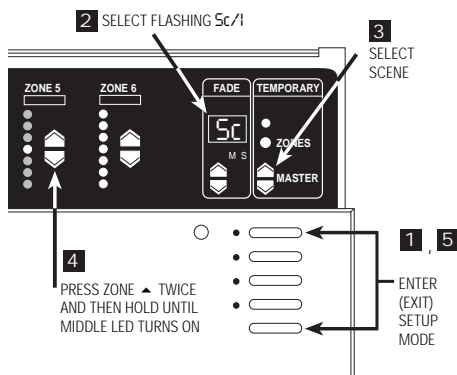

You can set up a zone to be “unaffected” when a certain scene is selected. (The unaffected zone’s light levels remain unchanged when the new specified scene is selected.)

- 1. Enter setup mode.** Press and hold Scene 1 and OFF buttons about 3 seconds until scene LEDs start cycling.
- 2. Select Sc** (the code for scene setup) by pressing FADE ▲ twice. Sc and 1 (for scene 1) will alternately flash in the FADE window.
- 3. Select scene.** Press MASTER ▲ and ▼ to select the scene that will have the unaffected zone.
- 4. Program any ZONE as unaffected.** Press ZONE ▼ twice and then hold until all the bargraph LEDs go out and the middle LED lights. (It may take up to 10 seconds after the last LED goes out until the middle LED lights.) This zone’s light levels will no longer be affected when this scene is selected. Note that you can set up several zones to be unaffected in a scene.
- 5. Exit setup mode.** Press and hold Scene 1 and OFF buttons until LEDs stop cycling.

How to set Save Options— OPTIONAL

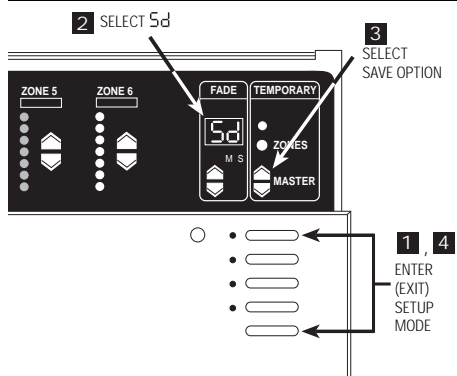

The GRAFIK Eye 3000 Series Control Units allow selection of several different Save Options. Follow these steps to access the Save Options.

- 1. Enter setup mode.** Press and hold Scene 1 and OFF buttons for about 3 seconds until scene LEDs start cycling.
- 2. Select Sd.** Press FADE ▲ until Sd is displayed in the FADE window.
- 3. Select Save Options.** Press MASTER ▲ and ▼ to select between the Save Options:
 - Sd **Save by Default.** Changing a zone’s intensity level or fade time permanently changes the preset scene. To temporarily change a light level, see “How to adjust light levels temporarily” on page 8.
 - Sb **Save by Button.** TEMPORARY ZONES LED is normally ON and all intensity and fade changes are temporary unless the TEMPORARY ZONES LED is turned OFF with the TEMPORARY ZONES button.
 - Sn **Save Never.** TEMPORARY ZONES LED is permanently ON and cannot be turned OFF. In this mode, all intensity changes are temporary.
 - 4S **Four Scenes.** This only allows the four Scene buttons, OFF button, IR receiver and the MASTER ▲ or ▼ to operate. All other buttons on the Control Unit are disabled.
 - bD **Button Disable.** All buttons on the Control Unit are disabled. IR Receiver, and Wallstations are still functional. (Setup mode is still accessible by repeating Step 1.)
- 4. Exit setup mode.** Press and hold Scene 1 and OFF buttons until scene LEDs stop cycling.

STEP 4: Setting Up System Communications

This section shows how to set up communications between Wallstations and the Control Units they should operate.

Do not set up communications . . .

- If you have only one Control Unit and . . .
 - you have up to three of the following Wallstations: NTGRX-4S, -4B, -4S-IR, -4S-DW, or EGRX-4S, -4S-IR, in any combination.

Close this manual and relax — your project will work as specified without any further wiring or setup!

Do set up communications . . .

- If you have more than one Control Unit or . . .
- You have Wallstations other than the NTGRX-4S, -4B, -4S-IR, -4S-DW, or EGRX-4S, -4S-IR.

IMPORTANT!

First check Class 2/PELV wiring.

Before you set up communications, make sure your Class 2/PELV system interconnections are working.

- Select Scene 1 (press the top button) on one of the Control Units.
- Is Scene 1 selected on all other Control Units and NTGRX-4S controls?

YES: Class 2/PELV wiring is OK. Proceed.

NO: Class 2/PELV wiring has a miswire. Check for loose connections, shorted or crossed links. Refer to Appendix A for details on Class 2/PELV wiring.

OR

GRAFIK Eye Control Unit has been addressed to other than R- (factory default). See below for more information on addressing Control Units.

Why do you set up communications?

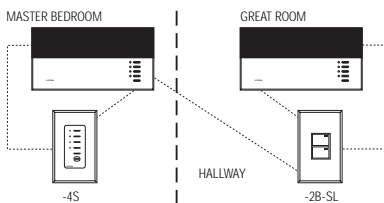

This diagram shows how Wallstations “talk” to Control Units in a typical residential project:

- The NTGRX-2B-SL in the hallway turns lights on and off in the master bedroom and great room. To do this, the -2B-SL “talks” to the Control Units in both of these rooms.
- The NTGRX-4S Scene Selection Control in the master bedroom allows you to choose four different lighting scenes. To do this, the -4S “talks” to the master bedroom’s Control Unit (but **not** to the Great Room’s Control Unit).



Press Scene 1 button . . .



. . . all other Scene 1 LEDs light!

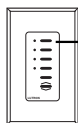

Assign addresses to GRAFIK Eye Control Units

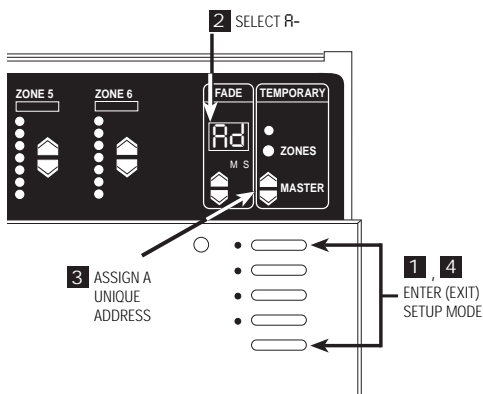

Assign each GRAFIK Eye Control Unit in your project a unique system address (R- through R8).

To assign an address:

1. **Enter setup mode.** Press and hold Scene 1 and OFF buttons about 3 seconds, until scene LEDs cycle.
2. **Select R-** (the address display). Press FADE ▲ once, R- appears in the FADE window.
3. **Assign a unique address.** Press MASTER ▲ once, the next “free” (unassigned) address automatically appears in the FADE window. This will be the Control Unit’s address. (If you are working on the first Control Unit in the project, R- will appear.)
4. **Exit setup mode.** Press and hold Scene 1 and OFF buttons about 3 seconds, until the LEDs stop cycling.
5. **Repeat** steps 1 through 4 for each GRAFIK Eye Control Unit.

Set up a Wallstation to “talk” to a “listening” Control Unit

In order for Wallstation to communicate with a Control Unit, each Wallstation must be individually configured to “talk.”

1. Enter setup mode.

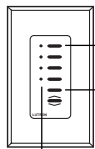

Press and hold top Scene and OFF button for 3 seconds . . .

. . . LEDs cycle—Wallstation is “talking”

2. Make the Control Unit “listen.”



Press and hold Scene 1 button for 3 seconds

. . . LEDs flash in unison—Control Unit is “listening”

3. Take the Wallstation out of setup mode.

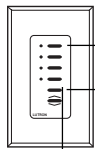

Press and hold top Scene and OFF button for 3 seconds . . .

. . . LEDs stop cycling

The communication link is now established. The Control Unit will “listen” when the user presses a button on the Wallstation. You can proceed to the next Wallstation and set up its communications.

For more specific, step-by-step instructions about setting up communications for each type of GRAFIK Eye Wallstation, please refer to the instructions included with each Wallstation.

Set up 2-way communication between 2 Control Units

This page explains how to use 2-way communications to set up lighting effects for more than six zones (the maximum number of zones any *one* 3000 Series Control Unit can operate). When you set up two-way communications between Control Units, selecting a scene at any one of these Units automatically activates the same scene in the others. By linking eight 6-Zone Control Units, you can create scenes that control the intensity of up to 48 zones. This “large-zone” capability is ideal for large spaces with dramatic lighting that changes frequently (e.g., churches).

For example: 16-Zone Control

Selecting a scene on A1 . . .

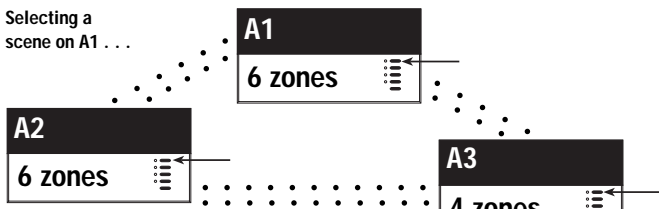

. . . Activates the same scene on A2 and A3.

Linked by two-way communications, these Control Units act like a 16-Zone Control Unit. Note that you must set up communications *both* ways among *all* Control Units:

- A1 “talks” to A2 and A3 — and “listens” to them as well.
- A2 “talks” and “listens” to A1 and A3.
- A3 “talks” and “listens” to A1 and A2.

Make sure you have addressed the Control Units (as described on page 10) before setting up two-way communications.

Set up communications in one direction . . .

1. **Put A1 in setup mode.** Press and hold Scene 1 and OFF buttons for about 3 seconds, until LEDs cycle.
2. **Identify the Control Units to “listen”** (A2 and up to 6 others). Press and hold the Scene 1 button for about 3 seconds until LEDs flash in unison, showing that these Control Unit(s) are “listening” to A1. (To make a “listening” Control Unit not listen to A1: Put A1 in setup mode, then press the “listening” Control Unit’s OFF button until the LEDs stop flashing.)
3. **Take A1 out of setup mode.** Press and hold Scene 1 and OFF buttons for about 3 seconds, until LEDs on A1, and all other linked Control Unit(s), stop cycling. You have set up communications in one direction between A1 and all “listening” Control Units.

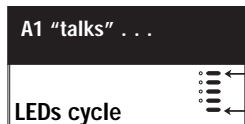

. . . then the other.

4. To complete the two-way communication, reverse the process described above: Put A2 in setup mode; then make A1 (and any other Control Units) “listen”; then take A2 out of setup mode.

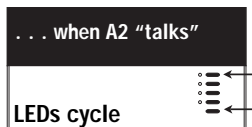

Appendix A: More about Class 2/PELV Wiring

This appendix explains the Class 2/PELV wiring used to carry communications between GRAFIK Eye Control Units and Wallstations.

Lutron requires that you connect (daisy-chain) all GRAFIK Eye 3000 Series Control Units and Wallstations with two twisted pair for operation. If shielded wire is used, the drain wires must be connected to each other or to Terminal D, if present. Drain wires should not be connected to Earth/Ground.

- One pair is for the low-voltage power wiring that enables each GRAFIK Eye Control Unit to supply power to up to three Wallstations. Connect this twisted pair to terminals 1 (COMMON) and 2 (12VDC). Terminate the 12VDC power to ensure that each Control Unit powers **no more than three Wallstations**.
- The second pair is for a data link (up to 2000 ft. or 450 m long) that enables Wallstations to communicate with GRAFIK Eye Control Units. Connect this twisted pair to terminals 3 (MUX) and 4 (MUX) of every Control Unit and Wallstation.

Each twisted pair in the Class 2/PELV wiring link should consist of two #18 AWG (1.0 mm²) stranded conductors.

- Lutron offers a one-cable (non-plenum), low-voltage solution. Please ask for P/N GRX-CBL-346S.

Recommended unshielded cables:

- For non-plenum installations, use (2) Belden 9470, (1) Belden 9156, or (2) Liberty 181P/2C-EX-GRN, or equivalent.
- For plenum installations, use (2) Belden 82740, or equivalent.

Wallstation circuits are classified as Class 2 circuits (U.S.A) and PELV circuits (IEC). Unless otherwise specified, the voltages do not exceed 24VAC or 15VDC. As Class 2 circuits, they comply with the requirements of NFPA 70, National Electrical Code (NEC). As PELV circuits, they comply with the requirements of IEC 60364-4-41, VDE 0100 Part 410, BS7671:1992 and other equivalent standards. When installing and wiring to these Wallstations, follow all applicable national and/or local wiring regulations. External circuits connected to input, output, RS232, DMX512, and other communication terminals of Wallstations, must be supplied from a Listed Class 2 source or comply with the requirements for PELV circuits as applicable in your country.

The GRAFIK Eye 3000 Series Control Unit Class 2/PELV circuit is 12VDC.

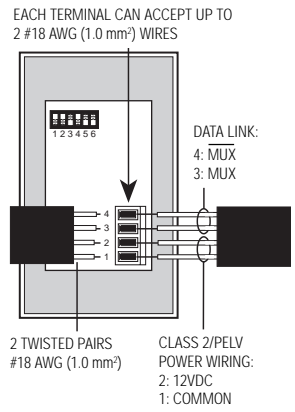

What is PELV?

In countries that abide by the IEC regulations, PELV is commonly referred to as Protective Extra-Low Voltage. A PELV circuit is an earthed circuit in which the voltage cannot exceed 50VAC or 120V ripple-free DC. The power source must be supplied by a safety isolating transformer or equivalent.

IMPORTANT WIRING NOTE!

Proper separation is required between the Line Voltage/Mains cables and PELV cables. Use certified cable for all Line Voltage/Mains cables and PELV cables. Cable bearing HAR or national certification marks are acceptable, provided it covers all applicable wiring regulations for fixed installations. See Important Wiring Note on page 3.

Small project: A Control Unit with up to three Wallstations

Each Control Unit can power up to three Wallstations. If you need to power more than three Wallstations from one Control Unit, install an external 12VDC power supply as described later in this section.

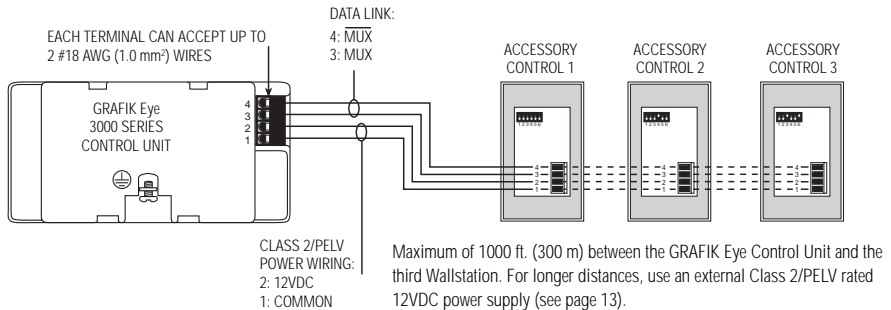

IMPORTANT WIRING NOTES!

1. Daisy-chain the terminal 1, terminal 2, terminal 3, and terminal 4 connections to all Control Units and Wallstations. The Control Unit has *its own* power supply.
2. Each Control Unit can power up to three Wallstations. If you need to power more than three Wallstations from one Control Unit, install an external 12VDC power supply as described later in this section.
3. Lutron recommends that all connections be made in the unit wallbox. Remote connection must be in a switchbox or junction box with a maximum wire length of 8 ft. (2.5m) from the link to the connected unit.

Note: Do not allow Class 2/PELV wires to contact line/mains wires. Refer to Class 2/PELV wiring on page 4.

Large project: Up to 8 Control Units and 16 Wallstations

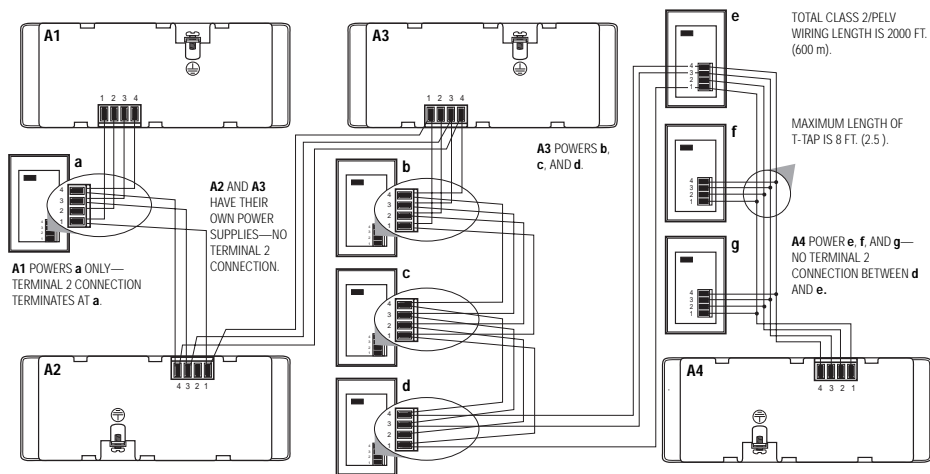

IMPORTANT WIRING NOTES!

- Daisy-chain the terminal 1, terminal 3, and terminal 4 connections to all Control Units and Wallstations. Each Control Unit has *its own* power supply. Terminate the terminal 2 connection (12VDC power) so that:
 - Each Control Unit supplies power to a *maximum* of three Wallstations.
 - Each Wallstation receives power from only *one* Control Unit.
- Lutron recommends that all connections be made in the Control Unit's wallbox. Remote connection must be in a switchbox or junction box with a maximum wire length of 8 ft. (2.5 m) from the link to the connected unit.

Note: Do not allow Class 2/PELV wires to contact line/mains wires. Refer to Class 2/PELV wiring on page 2.

Installing an external power supply

Install an external Class 2/PELV rated 12VDC power supply as shown below. This power must be Class 2/PELV rated and be a regulated supply rated for at least 50 mA per Wallstation on the link. It can supply power to up to 16 Wallstations, enabling you to use up to 16 Wallstations with one Control Unit.

Use an external power supply if you need to power more than 3 Wallstations from a single Control Unit or if your wire lengths exceed maximums. Power supplies do not boost data line signals. The distance limitation for the data line is 2000 ft. (450 m).

Make sure you review the manufacturer's instructions before installing.

Lutron offers a 12VDC transformer for 120V applications. Please ask for P/N GRX-12VDC.

IMPORTANT WIRING NOTES!

- Connect the +12VDC wire from the power supply to the terminal 2 connection on all Wallstations. Do not connect this wire to any Control Units on the link. Be sure that the terminal 1 connection is made to all Wallstations and Control Units.
- Lutron recommends these maximum distances from the external 12VDC power supply to the sixteenth Wallstation:
 - #18 AWG (1.0 mm²) wire: 300 ft. (90 m).
 - #12 AWG (2.5 mm²) wire: 1000 ft. (300 m).

Note that the allowable maximum distance depends on the number of Wallstations in the system. Please see Application Note W14 or consult the Lutron Technical Assistance Hotline for more detailed information.

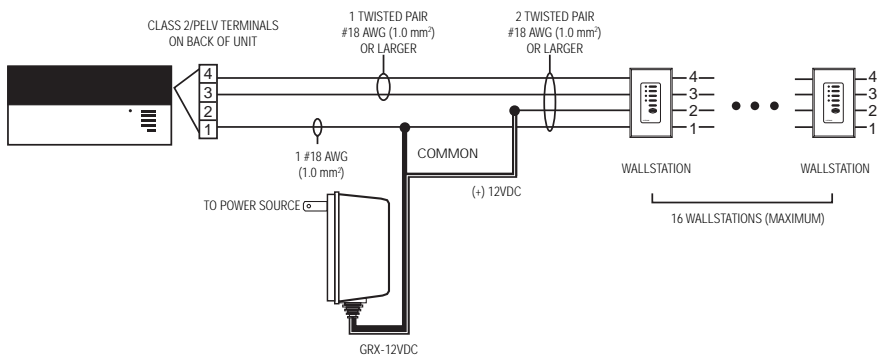

Appendix B: Special Mounting Considerations

Wallbox Mounting

Spacing of the GRAFIK Eye 3000 Series Control Unit

When mounting multiple GRAFIK Eye 3000 Series Control Units near each other, the following spacing and ventilation guidelines are required for proper operation.

- All GRAFIK Eye 3000 Series Control Units **MUST** be mounted in a standard U.S. Wallbox. These are available from Lutron.
 - For two-zone Control Units, Power Boosters, Fluorescent Interfaces, and Electronic Low-Voltage Interfaces, use two P/N 241-519 single-gang wallboxes.
 - For three-zone Control Units, use three P/N 241-519 single-gang wallboxes.
 - For four-zone (or larger) Control Units, use one P/N 241-400 four-gang wallbox.
- Note:** All GRX-CE Control Units mount in one P/N 241-400 four-gang wallbox.
- All GRAFIK Eye 3000 Series Control Units, Power Boosters, Fluorescent Interfaces, and Electronic Low-Voltage Interfaces **MUST** have 4 1/2 in. (11 cm) of space above and below the faceplate to dissipate the heat caused by normal operation.

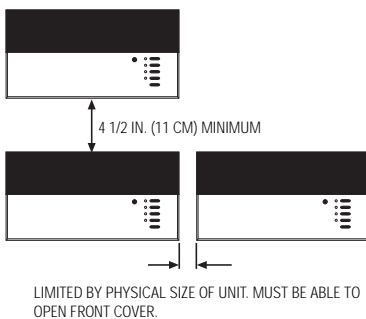

Panel Mounting

- The enclosure must be in accordance with all local and national electrical codes.
- Lutron does not recommend using a door to enclose the front of a panel, since this restricts airflow to the GRAFIK Eye 3000 Series Control Units and Interface Devices.
- If mounting multiple GRAFIK Eye 3000 Series Control Units or Interface Devices in an enclosure:
 - Ambient temperature within an enclosure **MUST remain between 32°—104° F (0°—40° C)**.
 - If not mounting in a metal enclosure, all units **MUST** be mounted in a wallbox. Refer to Wallbox Mounting above.
- To improve heat dissipation of Interface Units, (i.e., NGRX-PB, GRX-ELVI, etc.), remove the faceplate from the unit.

IMPORTANT NOTE:

GRAFIK Eye 3000 Series Control Units and Interface Devices, such as NGRX-PB, dissipate heat when operating.

Obstructing these units can cause malfunction to both the Control Unit and the Interface Device if ambient temperature does not remain between 32°—104° F (0°—40° C).

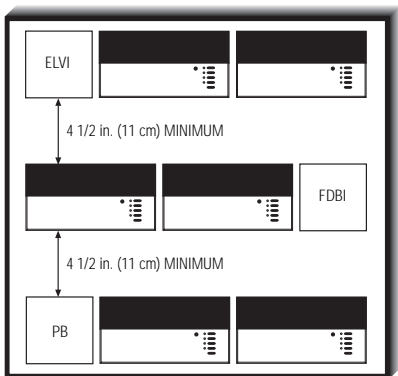

Appendix C: Power Boosters and Interfaces

This "load-side" equipment installs on the zone wiring between the Control Unit and the lighting load.

The **PB** increases a Control Unit's CAUTION! Test load for short circuits. zone load capacity for Incandescent/ Halogen (Tungsten), Magnetic Low Voltage, and Neon/cold Cathode load types. The **ELVI** enables a zone of the Control Unit to operate electronic low-voltage loads. The **FDBI** enables a zone on the Control Unit to operate fluorescent loads outfitted with Lutron's Hi-Lume or Eco-10 phase-controlled dimming ballasts.

CAUTION! Test load for short circuits.

- Turn power off.
- PB/ELVI: Connect standard switch between hot/live lead and the load wire to test circuit.
- FDBI: Connect standard switch between hot/live lead and the dimmed hot/live and switched hot/live leads of the ballast.
- Turn power on and check for short or open circuits.

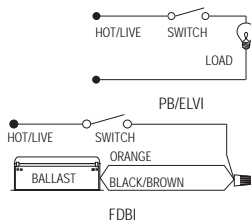

Wiring instructions

- Turn off power to the Control Unit and the feed to the PB, ELVI, or FDBI!
- Mount 2-gang wallbox: 3 1/2 in. (87.5 mm) deep recommended, 2 3/4 in. (68.75 mm) deep minimum. When mounting several units in a vertical layout (one underneath the other), allow at least 4 1/2 in. (11 cm) between units.
- Strip 1/2 in. (12 mm) insulation from #12 (2.5 mm²) 75 °C copper (CU) AWG wires and connect as shown. Please see the Instruction Sheet supplied with the unit for more detailed wiring diagrams.

Unit	120V	220-240V (AU)	230V (CE)**
PB	1920W/VA	2400W/VA	1840W/VA
FDBI	1920W/VA	2400W/VA	2400W/VA
ELVI	1000W/VA	1200W/VA	1200W/VA

* 1840W/VA surface mount, 1200W/VA flush mount.

Wiring detail

Mounting

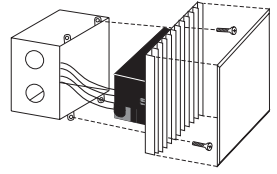
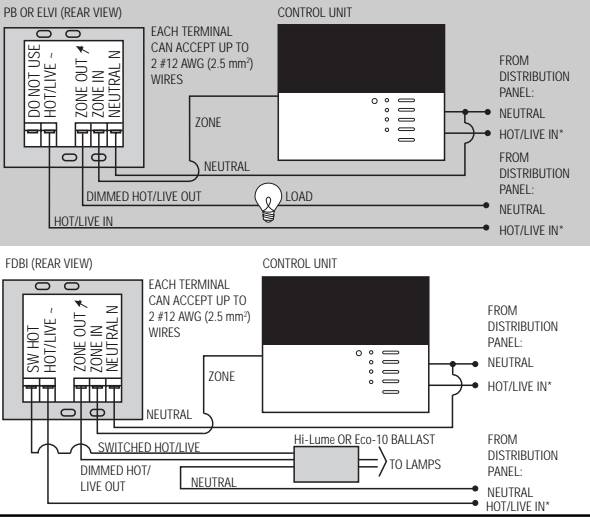

IMPORTANT WIRING NOTES!

Connect ZONE OUT only to Lutron Hi-Lume or Eco-10 Electronic Dimming Ballasts. Do not use this connection with any other fluorescent ballast or transformer.

* Can be on the same or different phases.

Appendix D: GRX-TVI 0-10 Volt Ballast/Switching Interface

Specifications

The GRX-TVI provides 0-10V control and ballast switching capabilities in one enclosure. The interface gives GRAFIK Eye 3000 Series Control Units the ability to control 0-10V ballasts powered by 100V to 277V and provides switching relays that can handle the in-rush current of ballasts. The interface gives GRAFIK Eye 3000 Series Control Units the ability to both dim and switch electronic ballasts, such as Lutron's Eco-10 (TVE models).

FEATURES

- Provides a Class 2/PELV isolated 0-10V output signal that conforms to EN60929 and IEC60929. Complies with UL Standard 508.
- Accepts a constant-gate drive fluorescent signal. (100-127V, 220-240V, 50/60Hz).

CONTROL INPUT POWER RATING 100-127/220-240V, 50/60Hz

L2/H2 TERMINAL INPUT RATING 20mA

DL2/DH2 TERMINAL INPUT RATING 100mA

0-10V OUTPUT RATING 10µA-300mA (maximum 150 ballasts)

OUTPUT SWITCHING CAPACITIES

Fluorescent (with Lutron TVE ballasts)	16A	10A
Fluorescent (with ballasts by others)	5A	5AX
Incandescent	16A	10A
Low Voltage	16A	10A
Metal Halide	16A	10A
Neon/Cold Cathode	16A	10A
Motor @ 100-127V	1/4Hp	—
Motor @ 220-277V	1/2Hp	—

Two #12-20AWG (0.5-2.5 mm²) conductors per terminal.

NEMA Type 1 enclosure, indoor use only.

32—104 °F (0—40 °C).

4.25 lb. (2kg)

TERMINALS

MOUNTING

ENVIRONMENTAL

WEIGHT

Installation

Mount on a wall using four screws. Use the unit to mark the position of the holes.

Terminal blocks on the PCB accept up to two #12 AWG (2.5 mm²) wires. This allows the interface to be wired in multiple ways. The GRX-TVI can be wired from one or two distribution panels. The switched power can be from a different source than the control power.

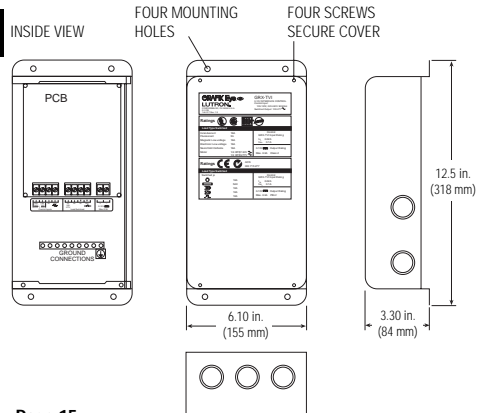

GRAFIK Eye Control Unit

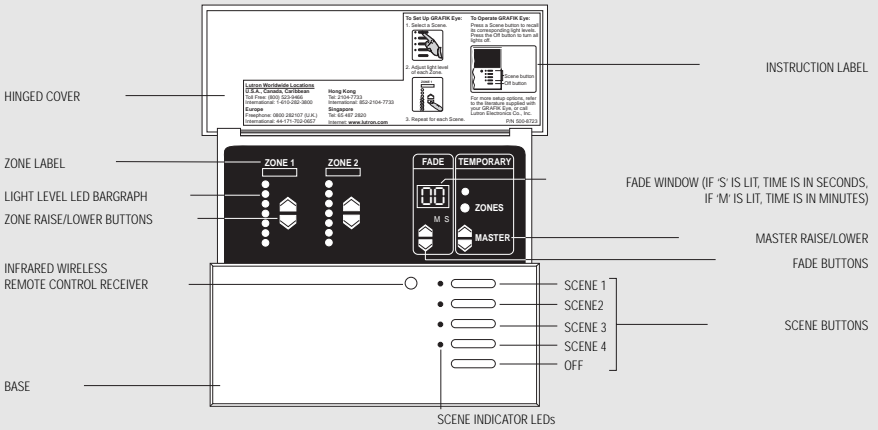

Wiring details: GRX-3106/3506*, GRX-3106-AU/3506-AU*

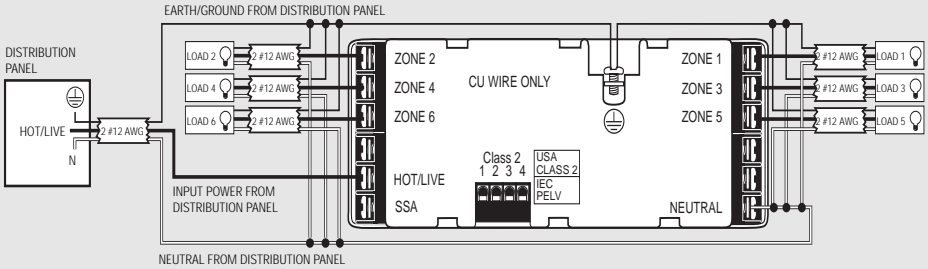

Wiring details: GRX-CE Models*

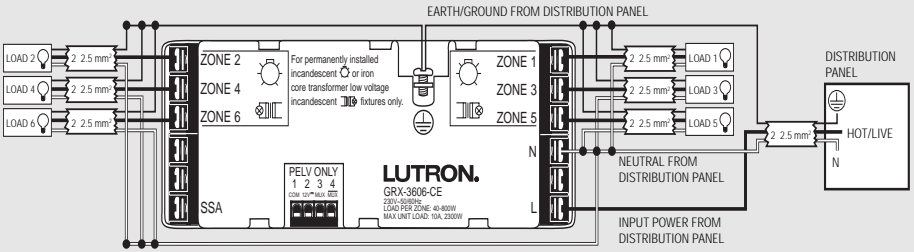

* For phase-to-phase and delta-feed wiring, please contact Lutron.

WORLD HEADQUARTERS

Lutron Electronics Co. Inc.
7200 Suter Road
Coopersburg, PA 18036-1299 U.S.A.
TOLL FREE: (800) 523-9466 (U.S.A., Canada, Caribbean)
Tel: (610) 282-3800; International 1 610 282-3800
Fax: (610) 282-3090; International 1 610 282-3090

EUROPEAN HEADQUARTERS

Lutron EA Ltd.
Lutron House
6 Sovereign Close
Wapping
London, E1 9HW, United Kingdom
FREEPHONE: 0800-282107 (U.K.)
Tel: (171) 702-0657; International 44 171 702-0657
Fax: (171) 480-6899; International 44 171 480-6899

ASIAN HEADQUARTERS

Lutron Asuka Corporation.
2nd Floor, Kowa Shiba-Koen Bldg.
1-11, Shiba-Koen 1 chome
Minato-ku, Tokyo
105-0011 Japan
TOLL FREE: (0120) 083417 (Japan)
Tel: (03) 5405-7333; International 81-3-5405-7333
Fax: (03) 5405-7496; International 81-3-5405-7496

HONG KONG SALES OFFICE

Lutron GL Ltd.
Unit 2911, 29th Floor
Bank of America Tower
12 Harcourt Road
Central, Hong Kong
Tel: 2104-7733; International 852-2104-7733
Fax: 2104-7633; International 852-2104-7633

SINGAPORE SALES OFFICE

Lutron GL Ltd.
6A Upper Cross Street
Singapore 053326
Tel: 220-4666; International 65-220-4666
Fax: 220-4333; International 65-220-4333

Lutron Electronics, Co., Inc., reserves the right to make improvements or changes in its products without prior notice. Although every attempt is made to ensure that this information is accurate and up to date, please check with Lutron to confirm product availability, latest specifications and suitability for your application.



©1999 Lutron Electronics Co., Inc.
MADE AND PRINTED IN U.S.A 5/99 P/N 032-083 Rev. B

Appendix D: Wiring overview

A GRX Interface is required for each fluorescent dimming zone. (A 3-zone Control Unit with two fluorescent zones and one incandescent zone is shown as an example.)

Please note that the power feed to the Control Unit and H₂/L₂ of the GRX-TVI must be the same phase!

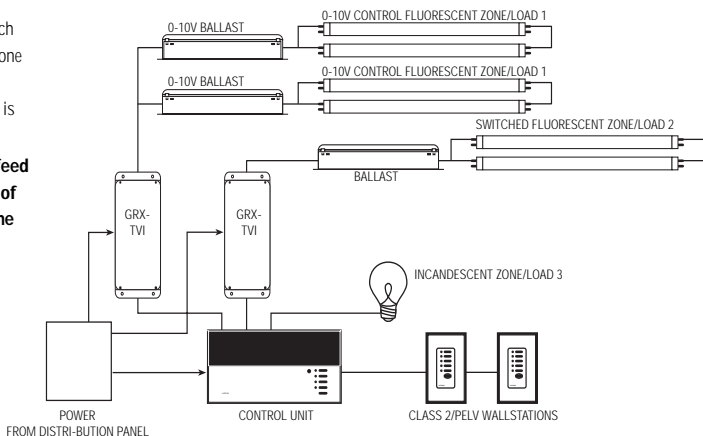

Appendix E: HP Dimming Modules (120V control feed only)

Not for use with generator-supplied power!

HP 2•4•6 Modules increase the load capacity of a Control Unit zone from 800W/VA to:

- 1920W/VA with the HP•2
- 3840W/VA with the HP•4
- 5760W/VA with the HP•6
- Up to 28,800W/VA by daisy-chaining five HP•6 Modules.

HP 2•4•6 Modules can also accept 277V input load power feeds to integrate 277V fluorescent dimming loads controlled by Hi-lume or Eco-10 Electronic Dimming Ballasts with 120V 3000 Series Control Units.

Specifications

DESCRIPTION	MODEL NUMBER	No. OF OUTPUTS TO LOAD CIRCUITS	CAPACITY@ 120VAC, 20A
	HP•2	1	1920W/VA
	HP•4	2	3840W/VA
	HP•6	3	5760W/VA
POWER	Operating power: 0.20A per HP-Module, 120VAC supplied to control circuit. Input power for load circuit(s): 120 or 277, 60Hz VAC.		
ENVIRONMENTAL CAPACITIES PER LOAD CIRCUIT OUTPUT	LOAD TYPE	DIMMED 120VAC/277VAC	SWITCHED 120 VAC/277VAC
	Incandescent	16A	10A
	Magnetic/electronic low voltage; neon/cold cathode*	16A	10A
	Hi-lume or ECO-10 Fluorescent	16A	16A
	Fluorescent (non-dim)	—	16A
	Metal Halide	N/A	10A
	Dimmed and switched hot available for each output. 50W/VA minimum load per output.		

MAXIMUM HEAT DISSIPATION 200BTU per hour per load circuit output.

* For neon/cold cathode light sources, consult Lutron Application Note #25.

Choose a mounting location

- Must be within 1000 ft. (300 m) of the Control Unit.
- Must allow for adequate cooling. (Make sure ambient temperature is 32°—104 °F (0°—40 °C). Allow for adequate air space.
- Must be **at least** 6 ft. (1.8 m) away from sensitive electronic equipment.
- Must be placed where the HP 2•4•6's slight operating noise is acceptable.

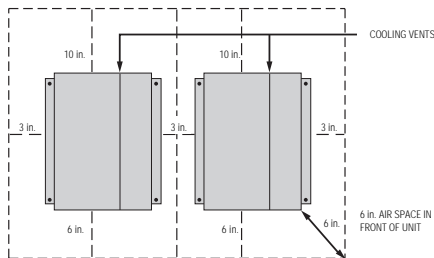

IMPORTANT!

Leave the HP 2•4•6's factory-installed bypass jumpers in place until you have installed and tested the Module.

Mounting

1. Hold unit vertically.
2. Mark and drill holes.
3. Using the keyed upper holes for easy positioning, secure the unit to the wall.

Please see the Instruction Sheet provided with the unit for more detailed programming instructions.

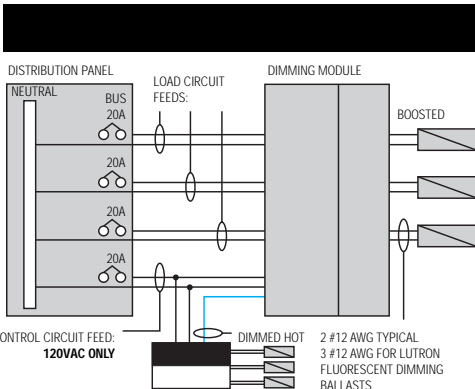

Appendix F: Infrared Transmitters

Infrared Transmitters

GRAFIK Eye Control Units are equipped with an Infrared Receiver. This allows control of the Control Unit with the optional Handheld Infrared Wireless Remote Control Transmitters. The Infrared Transmitters control 4 (or 8) scenes plus master raise/lower and Off. With this you can recall scenes or fine-tune light levels.

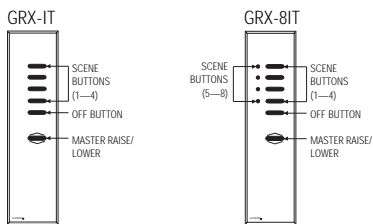

Infrared Interference

All GRAFIK Eye 3000 Series Control Units are equipped with an IR Receiver for use with Lutron GRX-IT and GRX-8IT handheld remote controls. The IR frequency for all Control Units is 40.000 KHz. Any other device continuously operating in the frequency range from 30 KHz to 50 KHz may cause either no response or unwanted scene changes on the Control Unit. Fluorescent ballasts are a known cause of IR interference to the Control Unit and Wallstations. Lutron dimming ballasts have been thoroughly tested to ensure that there is no IR interference with any GRAFIK Eye product. However, other manufacturer's ballasts may cause interference. It is the responsibility of the contractor to determine the operating frequency of the ballasts used on the project. Lutron takes no responsibility for ballast interference to the GRAFIK Eye system.

Appendix G: Troubleshooting

If the GRAFIK Eye lighting controls in your project aren't working as specified . . .

- Review carefully the GRAFIK Eye submittal documentation prepared for your project — especially the project's One-Line Diagram, which gives an overview of the wiring and shows how all GRAFIK Eye equipment connects. A sample One-Line Diagram is shown at right. The GRAFIK Eye Designer™ software, which produces such one-line diagrams, is available from Lutron.
- Consult the chart below to identify and correct the problem.
- If necessary, call Lutron.

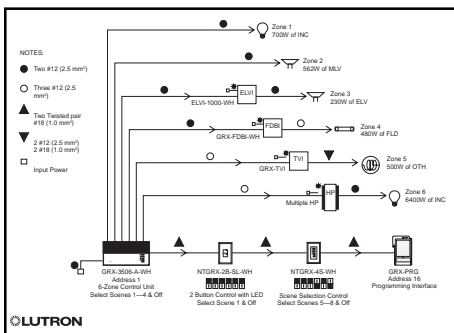

Problem

Cause

Remedy

Unit does not turn lights on	<ul style="list-style-type: none"> Breaker/MCB is off Long fade time Low zone settings Miswire System short circuit System overload 	<ul style="list-style-type: none"> Switch breaker/MCB on. Set FADE time to 0 seconds. Use zone ▲ for each scene. Check wiring (refer to wiring details). Find and correct shorts in fixtures and/or wallbox. Make sure lighting loads don't exceed Unit's maximum rated load.
Unit does not control load	Miswire	Check wiring (refer to wiring details).
ZONE control does not work	<ul style="list-style-type: none"> Disconnected wires Burned-out lamps 	<ul style="list-style-type: none"> Connect zone wires to loads (refer to wiring details). Replace bad lamps.
1 or more zones are "full-on" when any scene is on and zone intensity is not adjustable (and zone is not a non-dim)	<ul style="list-style-type: none"> Miswire Shorted triac 	<ul style="list-style-type: none"> Make sure loads are connected to the right zones (refer to wiring details). Replace Control Unit.
A ZONE control affects more than one zone	Miswire	Check wiring (refer to wiring detail).
Wallstation does not function properly	<ul style="list-style-type: none"> Miswire or loose connection Wallstation not set up properly 	<ul style="list-style-type: none"> Check and tighten loose connections at Class 2/PELV terminals on Unit and Wallstations (refer to Appendix A). Confirm programming.
Faceplate is warm	Normal	Solid-state controls dissipate about 2% of the connected load as heat.
Unit does not allow scene changes or zone adjustments	Unit may be set to an optional Save Option.	Refer to page 9 for Save Options.