

# XP/LP

COMBINATION  
SUBPLATE  
PANEL  
& 4000  
SERIES  
CONTROLS

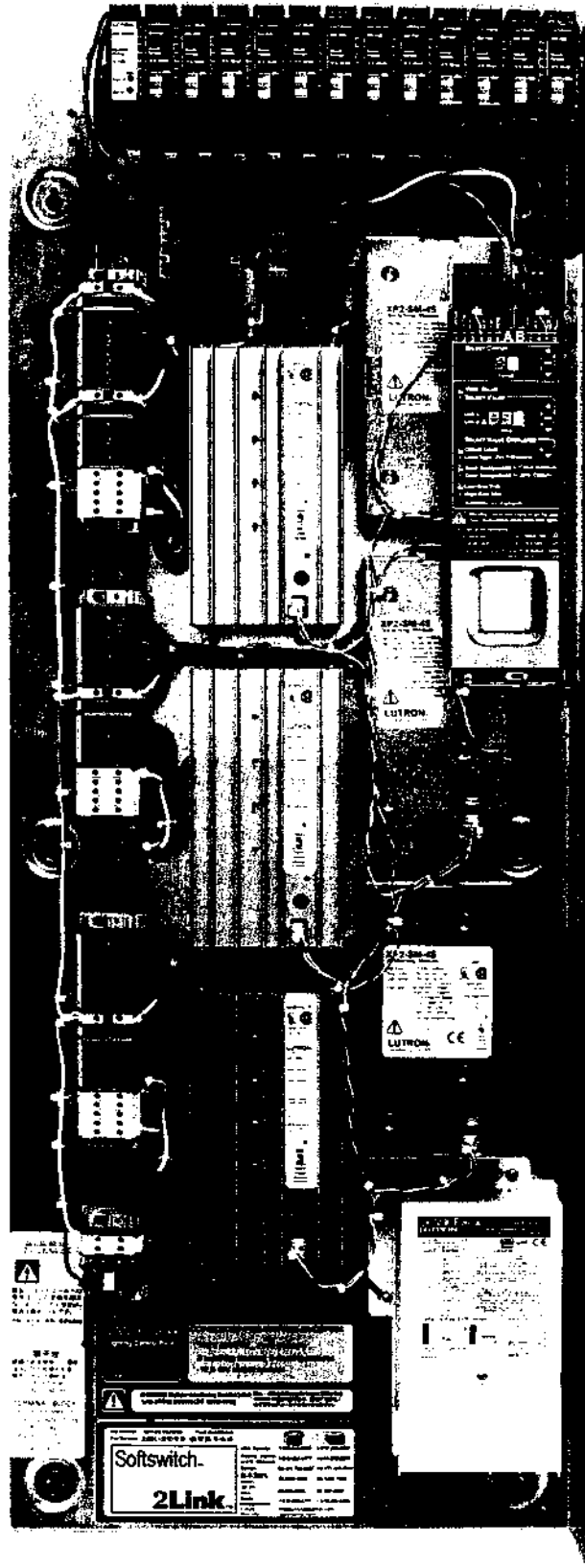

# Overview

**GRX-4000 Series Control Unit ( see Control Unit instructions for mounting and wiring details)**

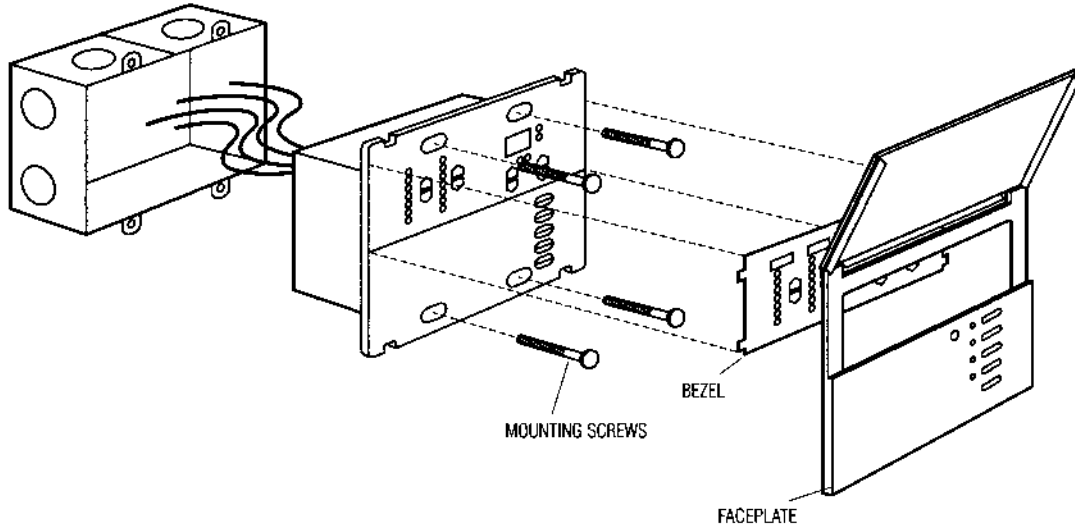

**GRAFIK Eye® XP/LP Combination Lighting Control Panel and XP Panel (See pg. 32 for a Larger Overview)**

**XP/LP Panel**

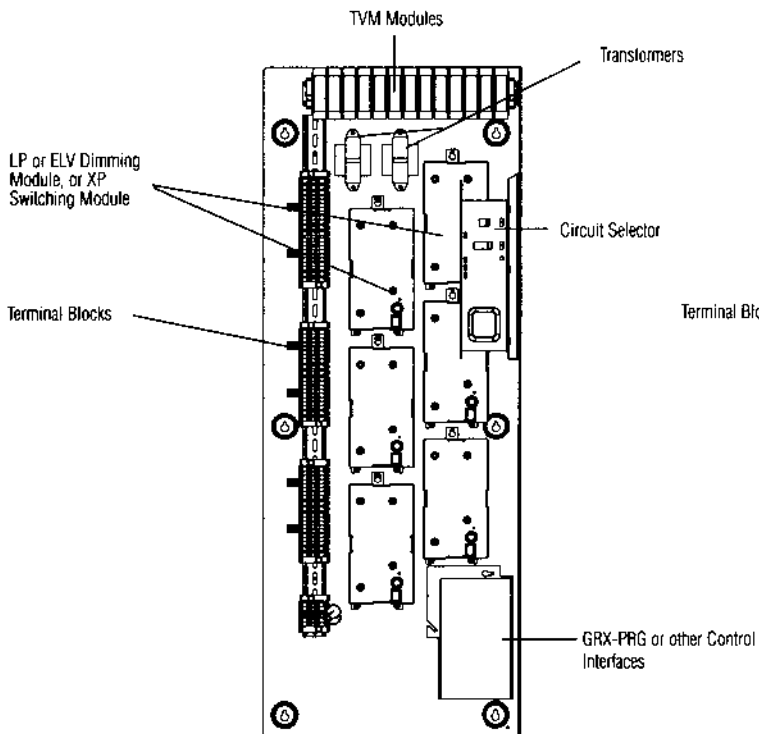

**XP Panel**

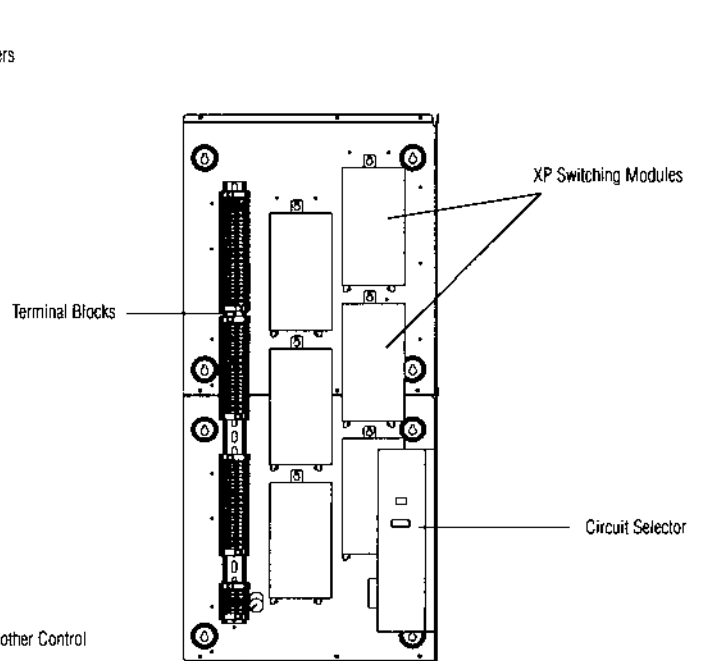

**Warning!** Lutron does **not** provide enclosure cabinets for these panels. It is strongly recommended that these panels be enclosed, by the customer, in a protective enclosure for safety reasons.

# Table of Contents











## Step-by-Step Instructions

<b>Install System</b>	<b>Page</b>	<b>Set Up System</b>	<b>Page</b>
STEP 1: Mount Wallboxes .....	2	STEP 14: Assign Primary Zones .....	17
STEP 2: Mount Panels .....	2-4	STEP 15: Set Up Non Dim Zones .....	18
STEP 3: Control Wiring .....	5-7	STEP 16: Set Low or High End (optional) .....	19
STEP 4: Load Wiring .....	8,9	STEP 17: Set Normal/Emergency Switch .....	20
STEP 5: Set Address Switches .....	10	STEP 18: Set Up Scenes on the GRX-4000 .....	21
STEP 6: Set Function Switches .....	11	STEP 19: Set Up Wallstation and Control Interfaces .....	22,23
STEP 7: Install Wallstation .....	12		
<b>Start Up System</b>			
STEP 8: Activate Loads in Bypass .....	12		
STEP 9: Activate Control Units .....	13		
STEP 10: Assign Load Types .....	14		
STEP 11: Address GRX-4000 Control Units .....	15		
STEP 12: Remove Bypass Jumpers .....	16		
STEP 13: Check System .....	16		



## Reference Sheets

<b>Set Up System</b>	<b>Page</b>	<b>Load Wiring</b>	<b>Page</b>
 Save options .....	25	 Fluorescent Wiring Information .....	33
 16 and 24 zone GRX Control Units .....	26		
 Control Directory .....	27	<b>Troubleshooting Guide</b>	
 Circuit Selector Functions, Address, 2Link™ options .....	28-31	 Troubleshooting Guide .....	34,35
<b>Look Inside a Panel</b>		<b>Maintenance</b>	
 XP/LP Combination Panel & XP 4 - 48 .....	32	 Maintenance .....	36
<b>Glossary of Terms</b>			
		 Glossary of Terms .....	37



# Mount Wallboxes and Panels

## STEP 1: Mount Wallboxes

Use wallboxes with a minimum depth of 70 mm for Wallstations and 89 mm for GRX-4000 Series Control Units.

Multigang installations may require spacers between wallboxes.

Mount wallboxes flush to 3 mm below finished wall surface.

Finished wall should not have gaps around the wallbox of greater than 3 mm.

Control	Wallbox	
GRX-CIR	none – use mounting ring (provided)	
GRX-4S-DW	Lutron # 241-399 (provided)	
Control Interface	1900 Box (4"x4" box) or Lutron #241-496	
<b>Control Units</b>	<b>GRXSLD</b> 3,4 zone (3 gang) 6,8 zone (4 gang)	Lutron # 241-519 89 mm deep (1 gang each, gangable) or 70 mm / 89mm deep US Wallbox or
	<b>GRX-4100/4500</b> 2 zone (2 gang) 3 zone (3 gang) 4-24 zone (4 gang)	Lutron #241-400 70 mm deep (4 gang) or Lutron # 241-519: 89mm deep, (1 per gang, 4 required)
All Others (1 gang)		



**For More Information . . .**  
See instructions packaged with each control.

## STEP 2: Mount Panels

### XP/LP Combination Panel

(Dimensions)

Left Side

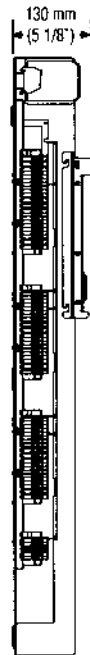

Front View

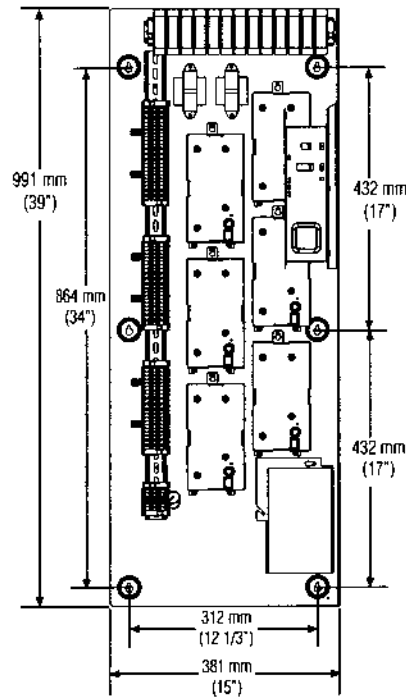

Right Side

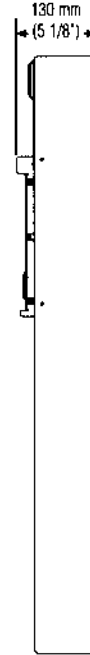

Bottom View





## STEP 2: Mount Panels (continued)

### XP 4-48 Series

(Dimensions)

**Note:** Refer to the previous page (pg 2, Combination Panel) to find the side view dimensions. These figures are identical for XP/LP panels.

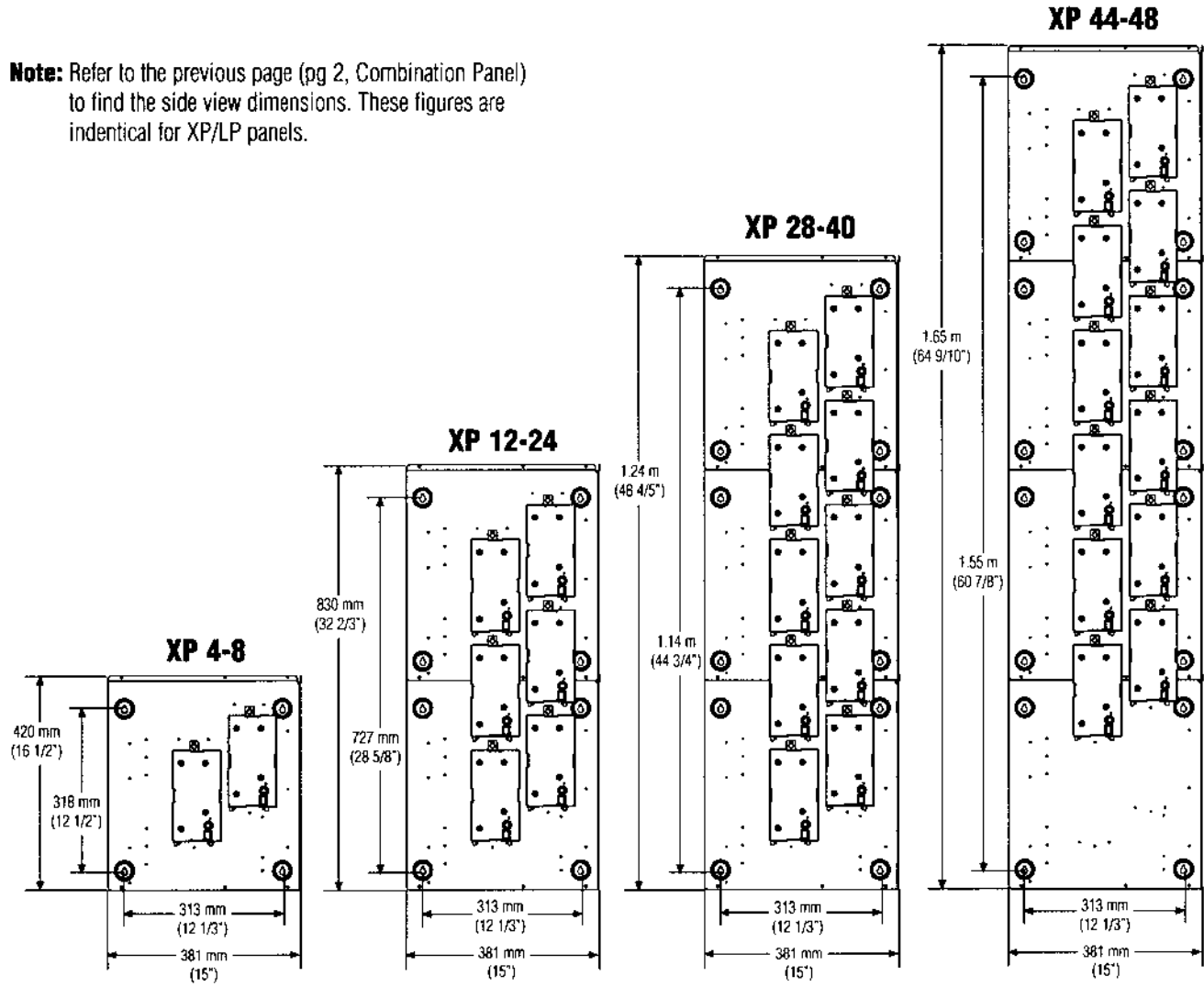

For More Information . . .



Look inside a Panel.....32



# Mount Wallboxes and Panels

## STEP 2: Mount Panels (continued)

### Notes:

- Panel generates heat. Mount only where ambient temperature will be 0 °C–40 °C.
- Reinforce wall structure as required for customer -supplied enclosure weight and local codes.
- Panel clearances are 305 mm above and below and 0 mm to each side. (allow room for Class 2/PELV clearance).
- Indoor use only.
- Relative Humidity < 90% non-condensing.
- XP/LP Panels must be mounted within 7° of true vertical.

Module	Max Kcal/Hr.
LP1 or ELV1 Module	23
LP2 or ELV2 Module	43
LP3 or ELV3 Module	63
LP4 or ELV4 Module	83
LP5 or ELV5 Module	103
LP6 or ELV6 Module	123



**Caution! Dimming Panels will hum slightly and internal relays will click while in operation. Mount where audible noise is acceptable.**



**Caution! Mount panel so line (mains) voltage wiring will be at least 1.8 m from sound or electronic equipment and its wiring.**



**Caution! This equipment is air-cooled. It must be mounted in a well-vented enclosure, or else the warranty will be void.**



### For More Information . . .



Look inside an XP 4-48 . . . . . 32



Look inside an XP/LP Panel . . . . . 33



# Wire System

## STEP 3: Control Wiring

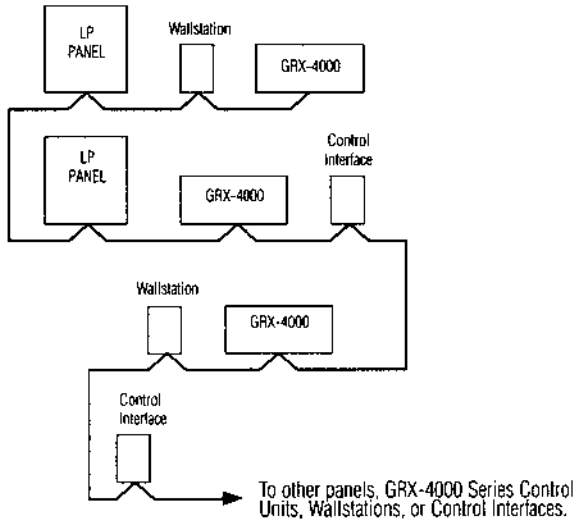

Correct: Daisychain OK

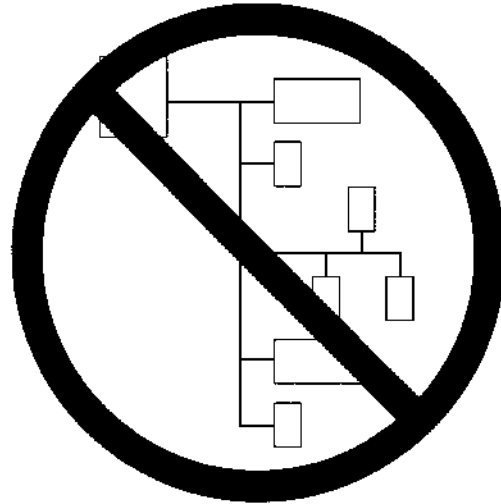

Incorrect: Branch or Home Run not acceptable

## Control Link Specifications

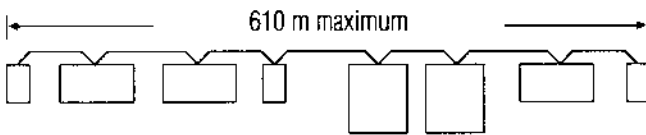

Total length of Control Link may be no more than 610 m. This distance is based on proper shielding on the twisted shielded pair, and on 3.5 mm<sup>2</sup> wire on the wires to terminal 1 and terminal 2 of the Control Link. If unapproved cable or smaller wire is used, this limit is affected:

### Terminal 1 & 2 Wires Sizes

3.5 mm<sup>2</sup>  
2.0 mm<sup>2</sup>  
1.25 mm<sup>2</sup>  
0.9 mm<sup>2</sup>

### Max. Control Link Length

610 m  
425 m  
275 m  
180 m

Total number of Wallstations, Control Units, Control Interfaces or Circuit Selectors = 33 maximum.

Total number of Control Unit addresses = 8 maximum

Note: GRX-4116/4516 has 2 addresses

GRX-4124/4524 has 3 addresses

Total number of Wallstation or Control Interface addresses = 16 maximum.

### Notes:

- Make wire connections inside the wallbox and LP panel or in a junction box (by others) within 2.4 m of the terminal.
- All control wiring is Class 2/PELV. Do not place any of these wires in with line voltage (mains voltage) wiring.
- The order of controls within the control wiring is not important.



**Questions on wiring?**  
Lutron may be able to help with charts of Wallstations versus distance.



# Control Wiring

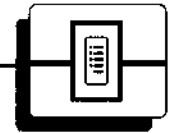

## STEP 3: Control Wiring (continued)

### Link A 1-to-1 Wiring (1 to 1, 2 to 2, 3 to 3, . . . )

To additional Control Units, Wallstations, Panels, or Control Interfaces

2 - 3.5 mm<sup>2</sup> from terminals 1 to 1, and 2 to 2

2 - 0.9 mm<sup>2</sup> twisted, shielded pair from terminals 3 to 3, and 4 to 4—Belden #9461 or Alpha #2211 are recommended

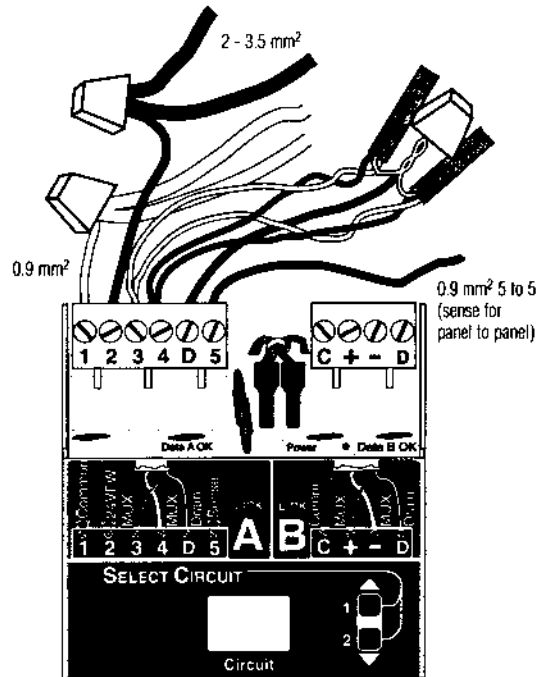
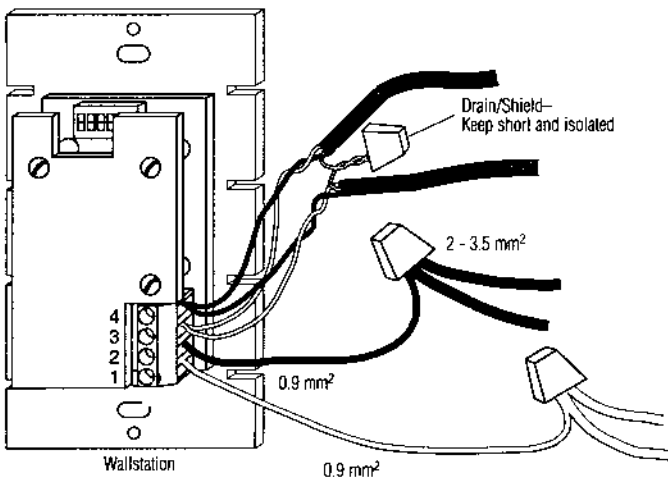
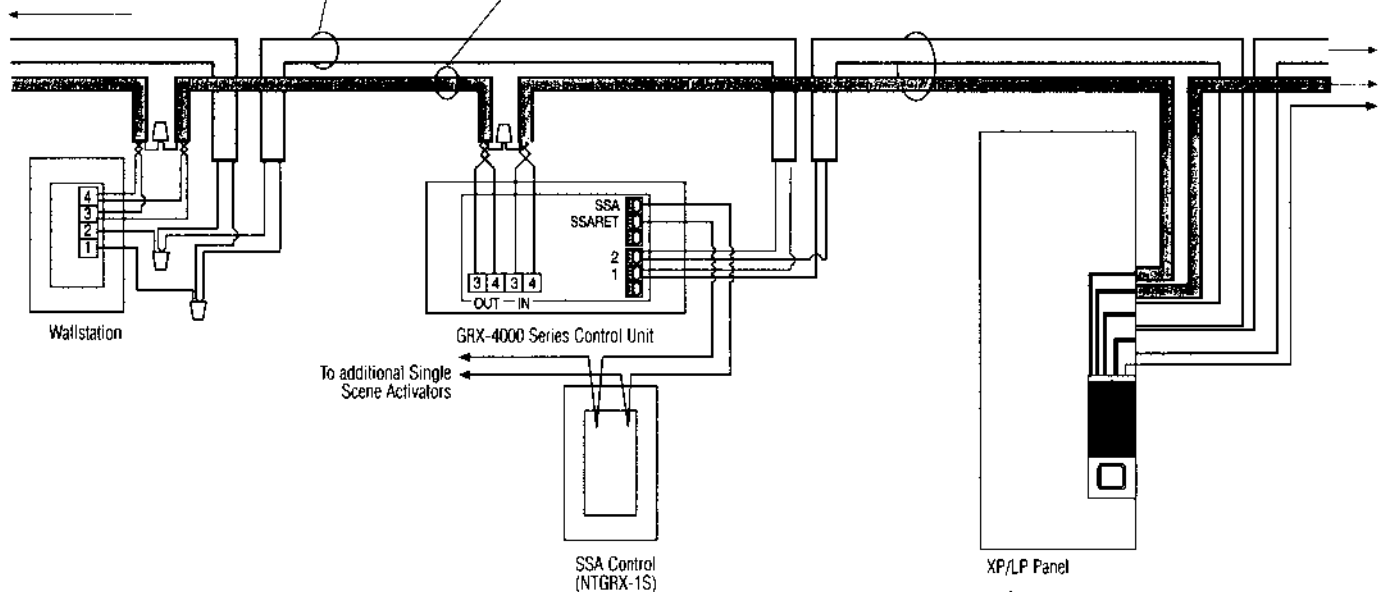

#### Notes:

- **Caution!** Do NOT connect high-voltage power to low-voltage terminals. Improper wiring can result in personal injury or damage to the equipment.
- Use the wire connector required by local code .
- Connect the Drain/Shield to terminal 'D', if this terminal is available. The Drain is a bare wire – care must be taken so that it does not touch ground (earth) or wallstation circuitry.

Circuit Selector in the LP Panel

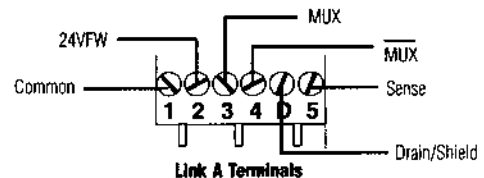





# Control Wiring for DMX

## STEP 3: Control Wiring (continued)

### Link B Wiring (C to C, + to +, - to -)

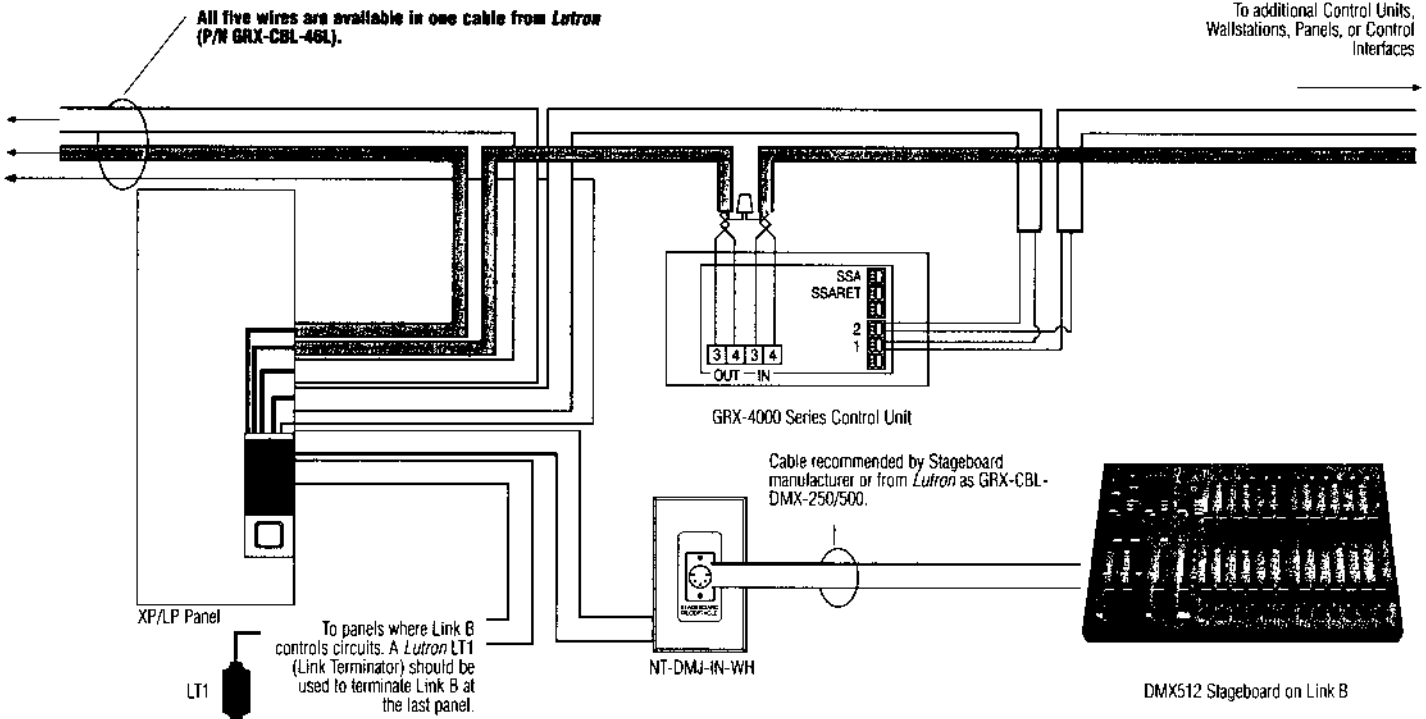

### Typical Wiring for Theatrical Applications: DMX to Link B (2Link™ only)

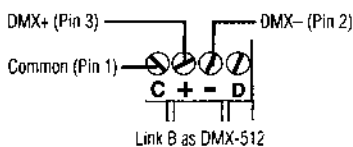
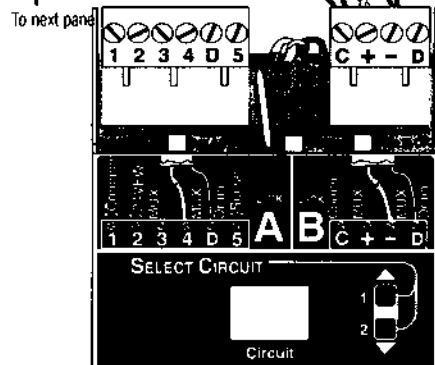
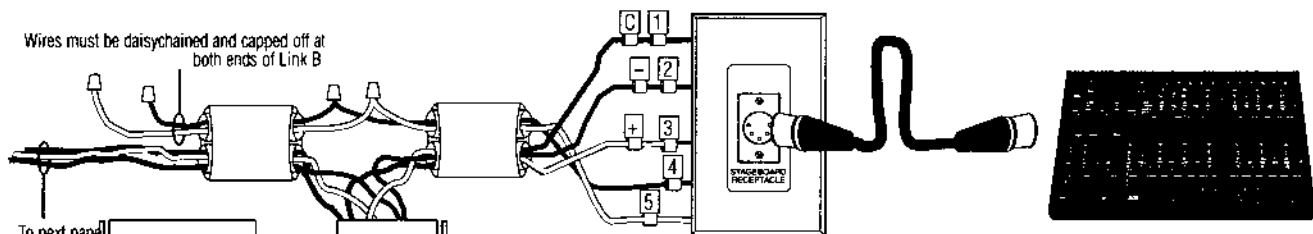

#### DMX Cable Wiring Table

DMX Cable Type	Wire	From Circuit Selector	To DMX Jack (Pin #)
Belden 9729/89729:	(2) drain/shield	C	C (1)
	white	+	+ (3)*
	black	-	- (2)*
	black	No Connect	- (4)
	red	No Connect	+ (5)
Lutron GRX-CBL-DMX-250/500:	drain/shield	C	C (1)
	white	+	+ (3)*
	black	-	- (2)*
	green	No Connect	- (4)
	red	No Connect	+ (5)

\* Wire in daisy-chain configuration as follows: C to C, + to +, and - to -.



# Load Wiring

## STEP 4: Load Wiring

### Load Circuit Wiring

Output terminal blocks accept one 2.0 mm<sup>2</sup> through 3.5 mm<sup>2</sup> or two 0.9 mm<sup>2</sup> through 1.25 mm<sup>2</sup> wire.



**Caution! Common Neutrals are not permitted. Run separate Neutrals for each load circuit.**



**Caution!** Verify with electronic low voltage transformer or ballast manufacturer that product can be controlled with a phase control dimmer before bypass jumpers are removed.

# IMPORTANT!

### Temporary Lighting

You do not need to install a temporary distribution panel. Place load wires into the appropriate terminal blocks.

Each Input Breaker can supply power to a load while the bypass jumper protects the dimmer from load faults.



**Caution!** Verify that the Panel is fed from the correct voltage. A feed miswire or loss of a feed neutral can cause overvoltage damage to the equipment.

LP or ELV Module

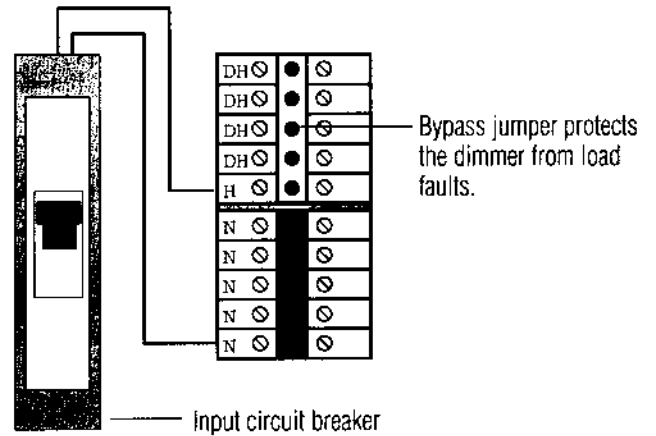

XP Module

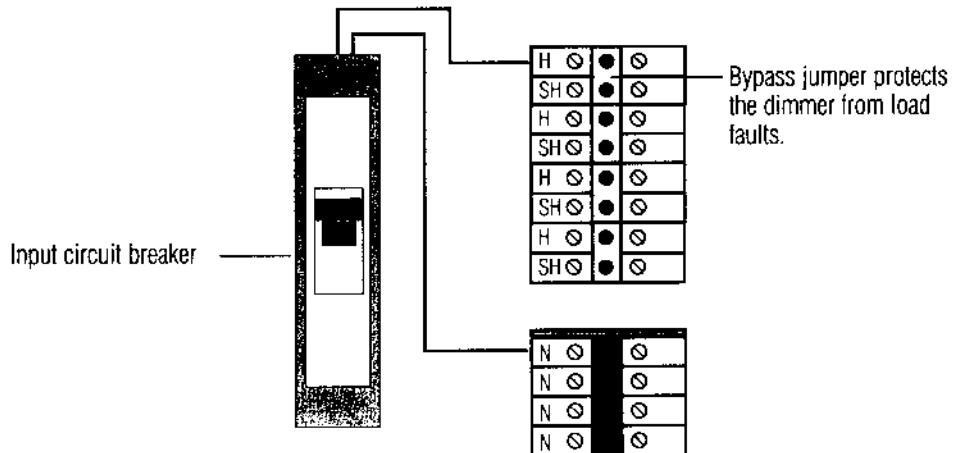



# Load Wiring

## STEP 4: Load Wiring (continued)

### Load Wiring for LP Module:

For all load types except ELV, *Hi-lume*<sup>®</sup> FDB or *Eco-10*<sup>™</sup> fluorescent dimming ballasts.

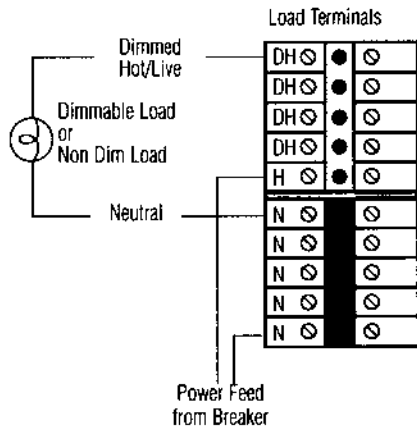

### Load Wiring for LP Module:

For *Hi-lume* FDB or *Eco-10* Fluorescent Dimming Ballast.

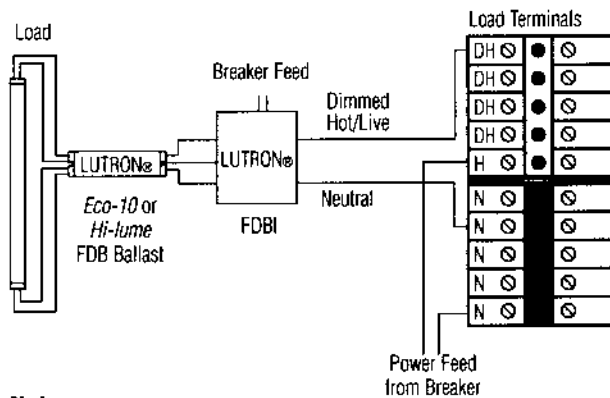

### Note:

- Run wiring so that line (mains) voltage wiring will be at least 1.8 m (6 ft.) from sound or electronic equipment and its wiring.

### Load Wiring for ELV Module:

For incandescent\* and dimmable reverse phase control electronic low voltage loads.

\* Load type 5-1 **must** be selected at the Circuit Selector regardless of the load type.

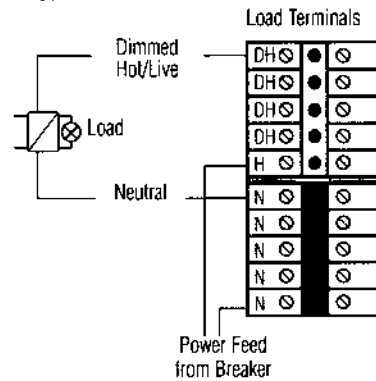

### Load Wiring for TVM Module (LP module only):

For 0-10V, PWM, and DSI loads. Each TVM controls two consecutive circuits of lighting and are the first circuits in the panel. Maximum low-voltage ballast control current: 50 mA per zone, 750 mA per panel.

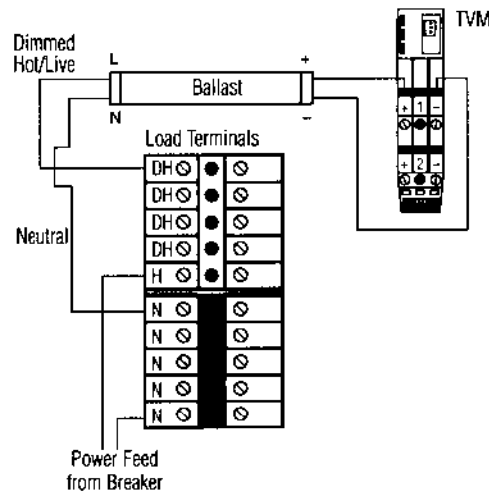

### Load Wiring for XP Module:

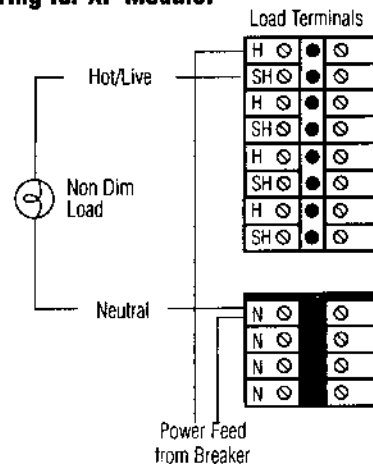

For More Information . . .



Fluorescent Wiring Information . . . . . 33



# Set Address Switches

## STEP 5: Set Address Switches

Control	Action	Address <span style="float: right;">1 2 3 4   5 6 7 8</span>	Function
 GRX-IT    NTGRX-1S    GRX-4000	No switches for addressing.	The address of a Control Unit is set later in this guide.	N/A
GRX-PRG	Automatically assigned.	Control 16	Setting Switch 1-8 requires knowledge of intended function.
  ALL OTHERS	<p>Must set switches BEFORE installing these controls.</p> <p>Set Switches 1-4 on each Wallstation and Interface Control to a <b>unique</b> address.</p>	<div style="display: flex; justify-content: space-between; margin-bottom: 5px;"> <span>1 2 3 4</span> </div> Control 1 Control 2 Control 3 Control 4 Control 5 Control 6 Control 7 Control 8 Control 9 Control 10 Control 11 Control 12 Control 13 Control 14 Control 15 Control 16	Setting Switch 5,6,7, or 8 requires knowledge of intended function.



**Caution!** Do not install controls in wallbox without setting the Address and Function Switches.

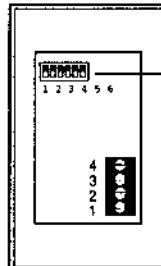

Switch location

Back of Wallstation

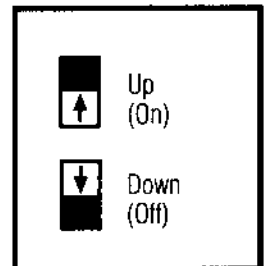

**Note:** This diagram shows a common Wallstation back. Some newer products may have a different layout. See product instructions for detailed drawings.



# Set Function Switches

## STEP 6: Set Function Switches

Wallstation or Control Interface	Function Set by DIP Switches on Wallstation/Interface								
	1 2 3 4		5 6 7 8		5 6		5 6		
	Factory Set								
<b>NTGRX-4S, NTGRX-4S-1R, NTGRX-4B, GRX-4S-DW,</b>    <b>GRX-CIR w/GRX-IT</b>	Select Scenes 1-4		Select Scenes 5-8		Select Scenes 9-12		Select Scenes 13-16		
<b>GRX-CIR w/GRX-8IT</b>	Select Scenes 1-8		Select Scenes 5-12		Select Scenes 9-16		Select Scenes 13-4		
<b>NTGRX-4PS</b>	Not Applicable		Not Applicable		Not Applicable		Not Applicable		
<b>NTGRX-4M</b>	Fifth button turns Control Units On only.		Not Applicable		Not Applicable		Fifth button turns Control Units Off only.		
<b>NTGRX-2B-SL</b>									
	Select Scenes 1 and Off		Select Scenes 9 and 10		Select Scenes 13 and 14		Panic Control		Fine Tuning Control
<b>GRX-AV</b>									
	Input 1	Scene 1	Scene 5	Scene 9	Scene 13	Scene 1	Scene 5	Scene 9	Scene 13
	Input 2	Scene 2	Scene 6	Scene 10	Scene 14	Scene 2	Scene 6	Scene 10	Scene 14
	Input 3	Scene 3	Scene 7	Scene 11	Scene 15	Scene 3	Scene 7	Scene 11	Scene 15
	Input 4	Scene 4	Scene 8	Scene 12	Scene 16	Scene 4	Scene 8	Scene 12	Scene 16
	Input 5	Off	Off	Off	Off	Off	Off	Off	Off
Output Type	Maintained Outputs				Maintained Outputs				
Input Type	Maintained or Momentary Inputs				Maintained or Momentary Inputs				
<b>GRX-RS232</b>									
	Input 1	Sequence 1-4	Sequence 5-16	Sequence 1-4	Sequence 5-16	Partition 1	Partition 1	on/off 1	off 1
	Input 2	Zone Lockout	Zone Lockout	Zone Lockout	Zone Lockout	Partition 2	Partition 2	on/off 2	off 2
	Input 3	Scene Lockout	Scene Lockout	Scene Lockout	Scene Lockout	Partition 3	Partition 3	on/off 3	off 3
	Input 4	Panic	Panic	Panic	Panic	Partition 4	Partition 4	on/off 4	off 4
	Input 5					Partition 5	Partition 5	on/off 5	off 5
Output Type	Maintained Outputs				Maintained Output				
Input Type	Maintained or Momentary Inputs				Momentary	Maintained	Maintained		
<b>GRX-PRG</b>	Switch	1	2	3	4	5 (RS232)	6	7	8
	Function	Zone Lock	Scene Lock	Sequence	Sequence Type	Fixed Address	Raw Feedback	Scene Status	Time Clock
<b>GRX-PRG</b>	On	Retain	Retain	Retain	5-16	1-4 Address	Report	Report	On
	Off	Off	Off	Off	1-4	Address 16	No Report	No Report	Off



# Install Wallstations and Activate Loads

## STEP 7: Install Wallstations

After wiring, setting address switches, and setting function switches, mount the Wallstations. Refer to detailed mounting instructions packaged with each control.

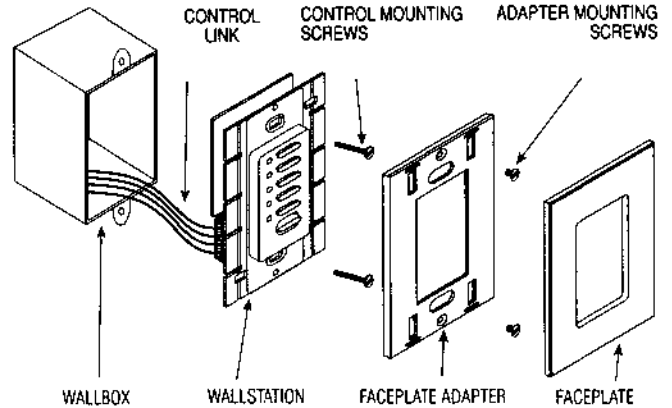

## STEP 8: Activate Loads in Bypass

### A. Complete load wiring.

### B. Check that the bypass jumpers are in place.

These jumpers protect the dimmers from load faults and must be used to check load wiring when it is installed or modified.



**Caution!** Verify that the LP Panel is fed from the correct voltage. A feed miswire or loss of a feed neutral can cause overvoltage damage to the equipment.

### C. Turn the circuit breaker ON for the first circuit.

The load should energize, the breaker should not trip, and total load current must be within the Circuit Breaker's limit and less than 16A.

### D. Repeat 'C.' for each circuit with completed load wiring.



**Warning!** DO NOT remove bypass jumpers at this time.



**Caution!** For proper dimming performance fluorescent lamps must be operated at full intensity for 100 hours prior to dimming.

See Maintenance Reference sheet in the Reference Section of this guide.

**Note:** For those who purchased Start Up with their *Lutron* Dimming System — you may want to stop here and have the *Lutron* Field Engineer set-up the system. Please call for a Start Up visit at least 5 working days before your requested date.

## Load Circuit Wiring

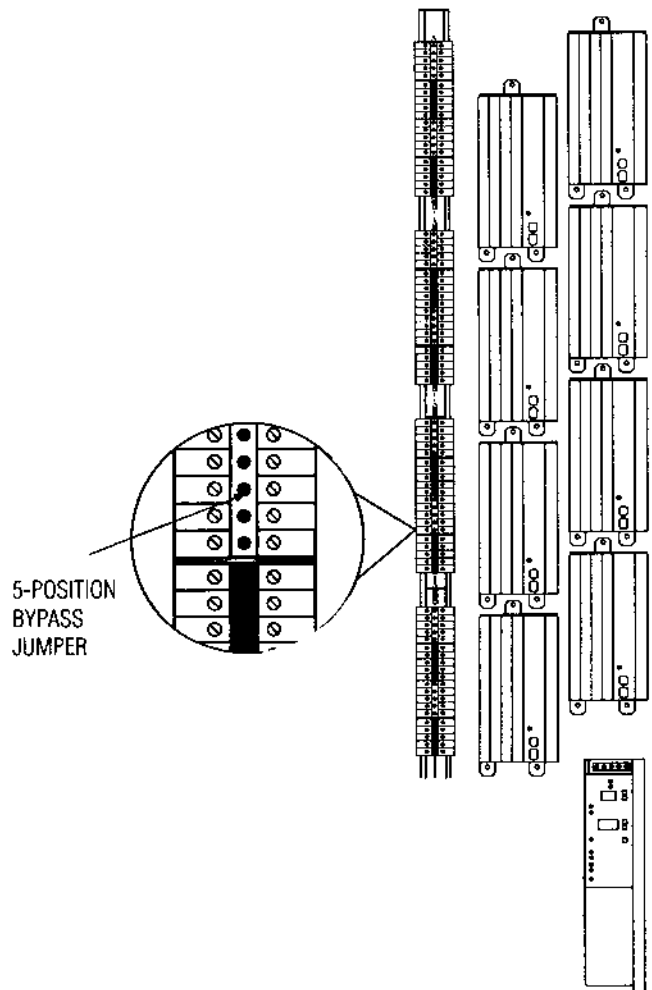



# Activate Control Units

## STEP 9: Activate Control Units

Once all controls are installed and wiring verified, turn control breakers ON.

Check that the **Power OK** LED at the top of the Circuit Selector is ON. If the **Power OK** LED is OFF, turn OFF the control circuit breaker (breaker 1), check for a short between wires 1 and 2, or 2 and ground. Turn control circuit breakers ON for all panels.

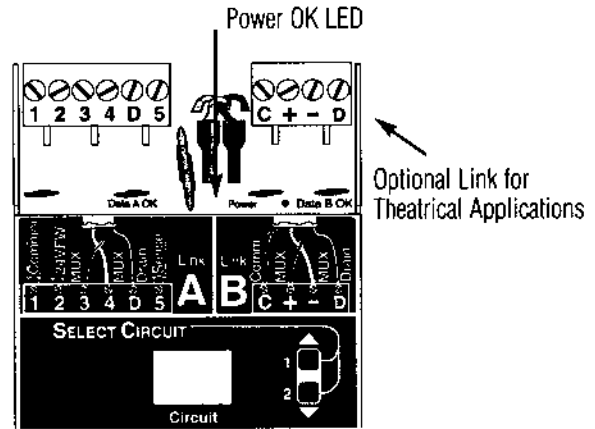

Push scene buttons on Wallstations. All GRX-4000 Series Control Units and Wallstations should act in parallel (e.g., pressing scene 1 on a Wallstation will select scene 1 on all Control Units, pressing a master raise button will raise all zones).

### Notes:

- Lights will not dim at this point.
- NTGRX-4PS, and NTGRX-4M will be inactive until Control Setup steps are completed.
- GRX-AV will be active only if set to affect scenes 1-4 and OFF (switches 5, 6, 7, and 8 all UP).
- NTGRX-2B-SL will be active only if set to affect scene 1 and OFF (switches 5, 6, and 7 all UP).
- Check for miswires if the controls do not act as described.

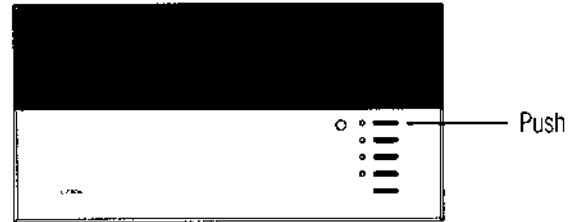

**GRX-4000 Series Control Unit**  
(6 zone unit shown)

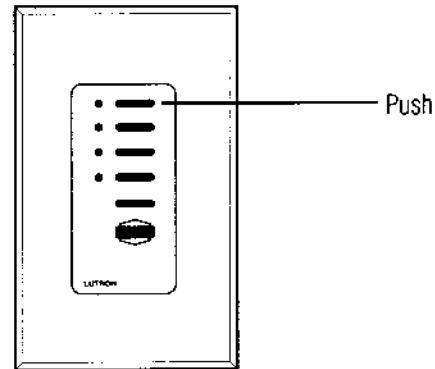

**Wallstation**  
(NTGRX-4S shown)

**?** For More Information...

Troubleshooting Guide.....38,39



# Assign Load Types

## STEP 10: Assign Load Types

Assigning Load Types is done using the Circuit Selector located in each LP panel.

To view present load types:

Press button 5 to step through the **Value** displays until **Load Type** LED lights. Use buttons 1 and 2 to view present load type of each circuit. Note that ' - - - ' in the **Value** display means a Load Type is not assigned to the circuit.

If load types are already assigned, compare them to the Circuit Directory (if provided). If there are no changes to be made, go to Step 11.

### To change load types:

- Press and hold buttons 1 and 5 until **SELECT VALUE** LED blinks once per second.
- Press button 5 to step through the **Value** displays until the **Load Type** LED lights.
- Choose circuit number with buttons 1 and 2.
- Use buttons 3 or 4 to choose the appropriate Load Type (see below for Load Type Display).
- Repeat Steps C and D for each circuit.
- Press and hold buttons 1 and 5 until the **VIEW VALUE** LED lights.

### Notes:

- The **Value** window will display the software revision level of the Circuit Selector 20 minutes after the last button press.
- Mark all changes to the Circuit Selector's values on a Circuit Directory for future reference.

### Load Type Display

- - - Unassigned (All intensities except 0 = On)
- 1 - 1 Incandescent, Tungsten
- 2 - 1 Fluorescent: Lutron *Hi-Lume* FDB or *Eco-10*
- 2 - 2 Fluorescent: Lutron Tu-Wire® (**not applicable in Japan**)
- 2 - 3 Fluorescent: 0-10V, with TVM module
- 2 - 4 Fluorescent: PWM, with TVM module (**not applicable in Japan**)
- 2 - 5 Fluorescent: Tridonic® DSI, with TVM module (**not applicable in Japan**)
- 3 - 1 Neon/Cold Cathode
- 4 - 1 Non-Dim: All intensities except 0 = On
- 4 - 2 Non-Dim: Intensities above 60% = On, below 40% = Off
- 5 - 1 Electronic Low Voltage
- 6 - 1 Magnetic Low Voltage

## Circuit Selector

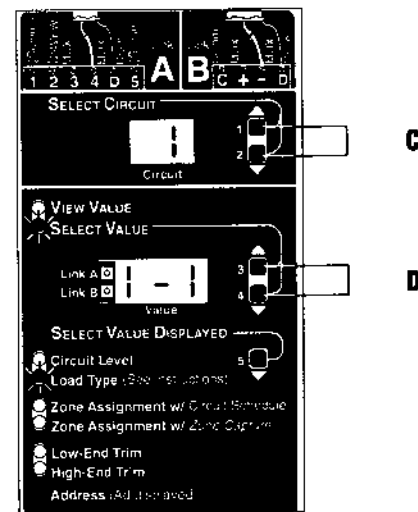
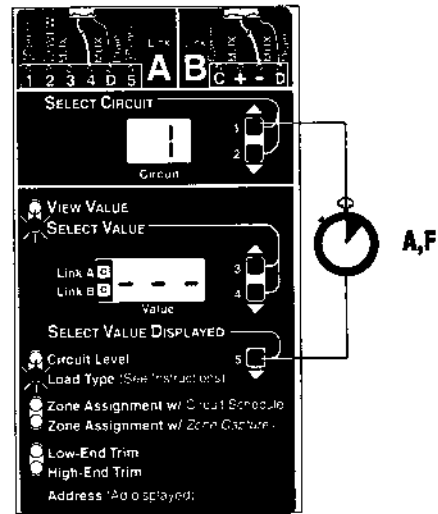

**Warning!** Failure to correctly assign Load Type may damage loads—especially certain Electronic Transformers, Electronic Ballasts, and Motors. Verify with transformer or ballast manufacturer that product can be dimmed with phase control dimming before setting to any Load Type other than Non-Dim.





# Address GRX-4000 Control Units

## STEP 11: Address GRX-4000 Control Units

**Note:** If using a 16 or 24 zone Control Unit, address these first.  
Address Control Unit as follows:

- Push and hold top and bottom scene buttons until scene LEDs begin to cycle.
- Push **FADE** ▲ button until 'A-' is displayed in the **FADE** window. If A(1-8) appears, then go to D since the Control Unit is already addressed.
- Push **MASTER** ▲ button once. The control will automatically choose the next available address. Note the address of each (A1-A8) on the Control Directory on Page 27.  
If a Control or Circuit Directory already exists, push **MASTER** ▲ and ▼ buttons to have the address match these directories.
- Press and hold the top and bottom scene buttons until the scene LEDs stop cycling.

Repeat Steps A-D on all GRX-4000 Series Control Units.

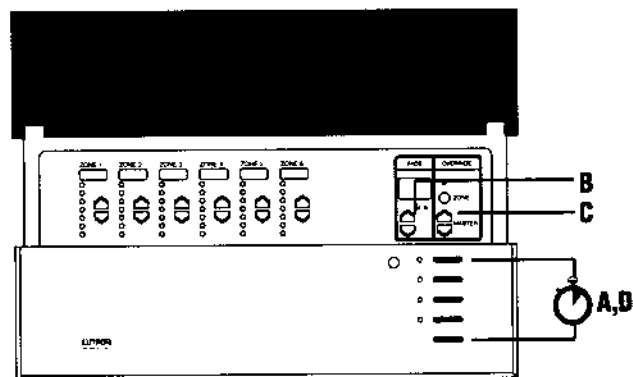

GRX-4000 Series Control Unit

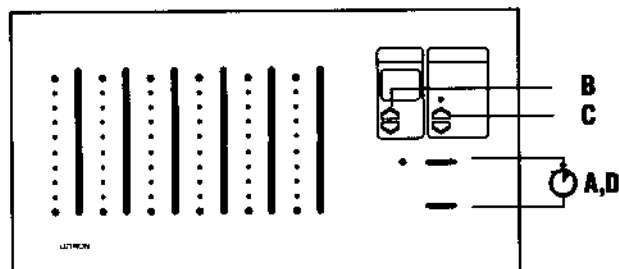

GRXSLED Control Unit (before installing faceplate and knobs)

As soon as a GRX-4000 Series Control Unit is addressed, check that the **Data OK** LED begins to flash on the Circuit Selector. Flashing indicates that the panel recognizes the communication from a GRX-4000 Series Control Unit.

**Note:** As soon as a GRX-4000 Series Control Unit is addressed, Wallstations will no longer have any affect on the GRX-4000 Series Control Units. The Wallstation communication will be reestablished later.

### LED Status

- Flashes once per second.
- Blank.
- Flashes rapidly\*.

### Meaning

- Control link data OK.
- No data present on link or Control Breaker (breaker 1) is Off.
- Incorrect data detected, possible causes: terminal 3 or 4 is not properly connected, or terminals 3 and 4 are miswired.

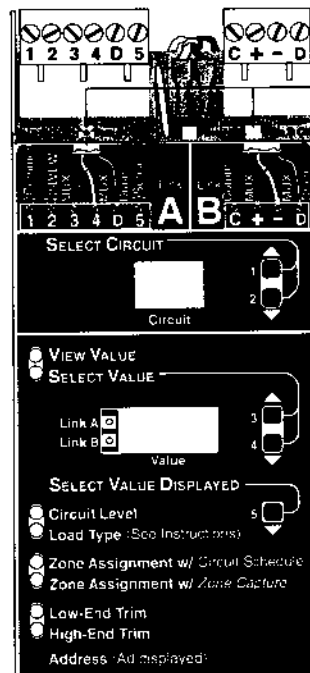

Data OK LED will be Off before addressing, then flash after addressing (approximately once per second)



### For More Information . . .



16 and 24 zone GRX Control Units . . . . .28



Troubleshooting Guide . . . . .38,39

\* The Circuit Selector may take up to 1 minute to properly identify a device on the link. During this time, a rapid flashing pattern may be observed.



# Remove Bypass Jumpers, Check System

## STEP 12: Remove Bypass Jumpers

After all load wiring has been checked, turn circuit breakers OFF and loosen all the screws of each bypass jumper. Remove and store the bypass jumpers for possible future use.

Turn circuit breakers ON.



**Warning!** Confirm that Load Types were correctly assigned. Some loads may be damaged if dimmed - especially certain electronic transformers and electronic ballasts and motors.



**Caution!** For proper dimming performance fluorescent lamps must be operated at full intensity for 100 hours prior to dimming. See Maintenance Reference sheet in the Reference Section of this guide. Loosen all screws of each bypass jumper. Remove and store the bypass jumpers for possible later use.



**Caution!** Reuse the bypass jumper whenever work has been done on a load. Damage caused by short circuits and miswiring is not covered in the product warranty.

### LP Module

BYPASS JUMPERS

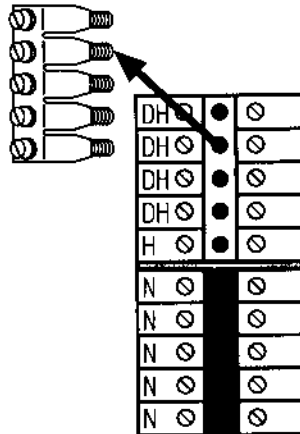

### XP Module

BYPASS JUMPERS

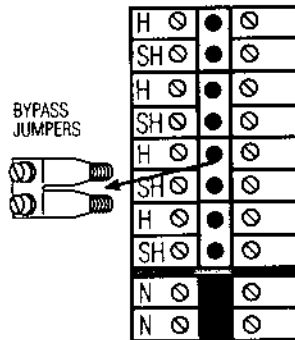

## STEP 13: Check System

Until zones are assigned, all circuits will be controlled by the first zone of the GRX-4000 Series Control Unit addressed to 'A1'. Locate zone 1 of this 'A1' control (referred to as **A1 1** in the Circuit Selector) and use it to check that all circuits dim smoothly and perform as expected (This address was set in Step 11).

### Notes:

If the system has already been set up, scenes will work and **A1 1** will not control all circuits. Circuits with Unassigned or Non-Dim 4 Load Types will not dim, but will only turn on and off.



For More Information . . .



Control Directory.....27

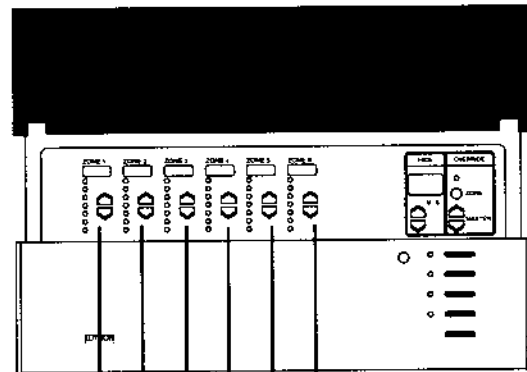

A1-1 First zone of GRX-4000 Series Control Unit addressed 'A1'



# Assign Primary Zones

## STOP!



Before proceeding, you must have one or more of the following:

- Preassigned set-up
- Knowledge of how the system is to operate.
- Plans and specifications from owner's representative on how the system is to be set-up.
- Owner or owner's representative present.

- **What should each scene be used for?**  
Examples include - Breakfast, Lunch, Meeting, Accenting, etc...
- **How long should it take for the lights to fade from scene to scene and to off?**  
Examples include - 1 second fade to "Meeting" scene, 10 minute fade to "Lunch" scene so customers do not notice, 20 second fade to "Off" scene to leave room before the lights go out, etc.
- **Do I have a 2Link™ option?**  
If so . . . see Link Hierarchy options in the Reference Section.

## STEP 14: Assign Primary Zones

- Press and hold buttons 1 and 5 until the **SELECT VALUE** LED flashes once per second.
- Press button 5 repeatedly until the **Zone Assignment w/Circuit Schedule** LED lights.
- Select the primary zone assignment.  
**GRX 4000 Series:** Press button 3 or 4 to select both Control Unit and zone assignment.  
Example - If the control desired is addressed to 'A2' and the zone desired is the 3rd from the left, use buttons 3 and 4 to get 'A23' as a value for the appropriate circuit.  
**6000 Series or DMX512:** Press button 3 or 4 to select zone assignment (1—512).
- Use buttons 1 and 2 to change to the next circuit and then repeat Step C. Do this for all affected circuits. Record each circuit's control and zone on a Circuit Directory.
- Press and hold buttons 1 and 5 until the **VIEW VALUE** LED lights.

### Notes:

- The Circuit Selector's display will go out automatically 20 minutes after the last button press.
- More than one circuit can be assigned to the same zone.
- **Zone Capture™** is an alternate method for assigning zones. It is described in the Circuit Selector Functions Reference Sheet.
- **2Link only-** The Link A and Link B LEDs located next to the **Value** window indicate which Link is being assigned as per the Hierarchy. To set the Hierarchy, see the reference sheet on **2Link** options in this guide.

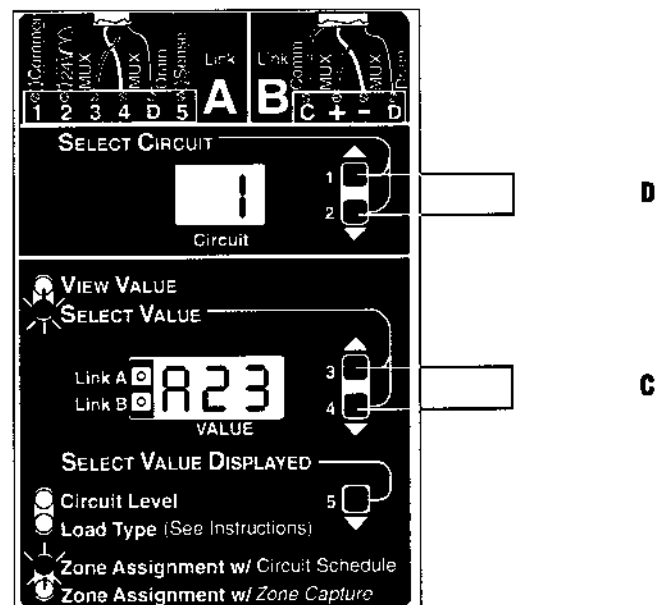
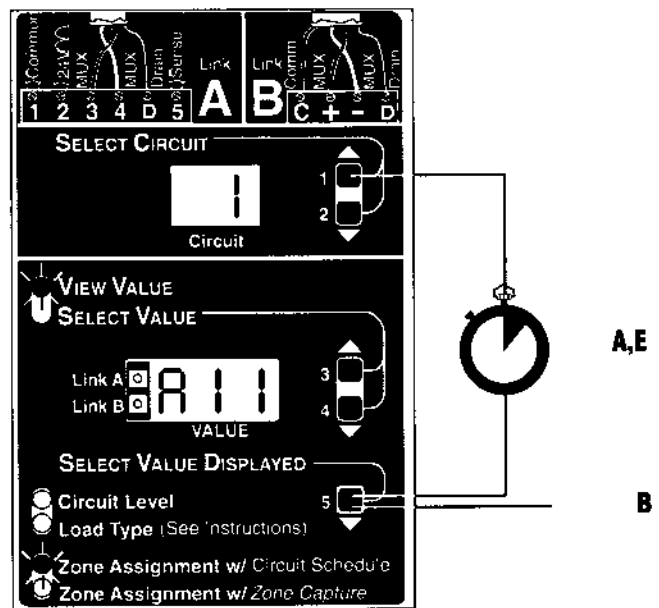

For More Information . . .



16 and 24 zone GRX Control Units .....26



# Set Up Non Dim Zones

## STEP 15: Set Up Non Dim Zones (GRX-4000 Series only)

For each zone assigned to a circuit with a Non-Dim Load Type, the LEDs on a Control Unit can be made to match the load intensity as shown:

- A.** Press and hold the top and bottom scene buttons until scene LEDs begin to sequence.
- B.** With 'LS' in the FADE window, press the zone button of the Non-Dim zone until the top 4 or 5 LEDs are on.

### Notes:

- The Circuit Selector Load Type must be set for Non-Dim on each circuit assigned to this zone.
- With 4 LEDs, the load will operate on a Last On, First Off basis. Load turns ON at the end of a fade to full and OFF at the beginning of a fade from full.
- With 5 LEDs, the load will operate on a First On, First Off basis. Load turns ON at the beginning of a fade to full and OFF at the beginning of a fade from full.

Repeat Step B for all zones controlling a Non-Dim Load Type.

- C.** Press and hold top and bottom scene buttons until scene LEDs stop sequencing.
- D.** Repeat Steps A - C for all other GRX-4000 Series Control Units with Non-Dim zones.

Lutron ships *GRAFIK Eye* Control Units with all zones set for dimming. For each zone that controls a circuit with a dimmable load type, the LEDs should match the load intensity as shipped.

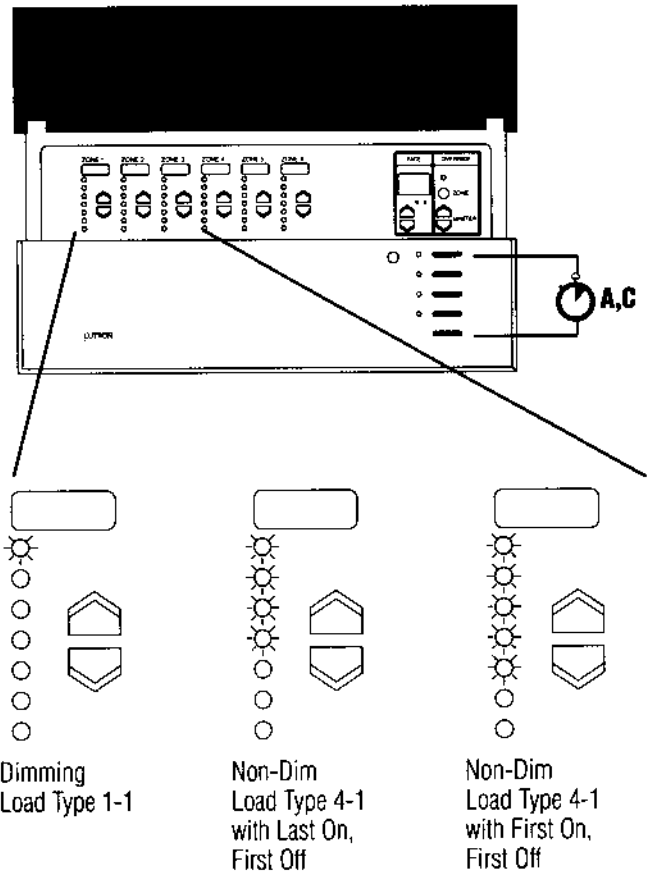



## Set Low or High End

### STEP 16: Set Low or High End (optional)

**Note:** Low End and High End light levels are set automatically when load type is assigned. This step is to be done if the default settings need to be changed.



**Warning!** Do not reduce the Low End or increase the High End on a Fluorescent Load Type. This will decrease lamp life and may damage the ballasts.



**Warning!** Do not increase the High End, of Neon/Cold Cathode. This may overdrive the lamps and cause decreased tube life.

#### To change the setting:

- Press and hold buttons 1 and 5 until the **SELECT VALUE** LED lights.
- Press button 5 repeatedly until the **Low End Trim** LED or the **High End Trim** LED lights.
- Use buttons 1 and 2 to go to the circuit that needs to be changed.
- Use buttons 3 and 4 to reset the trim as desired. The load will go to the new setting while in this mode despite the GRX control's intensity.

#### Notes:

- Low End and High End ranges are limited to avoid overlapping.
- '1' is the minimum Low End and '99' is the maximum High End.
- 'Value' is a relative number. It is **not** a % intensity, but rather a reference point to help set other circuits, if desired.

Record the new trim setting on a Circuit Directory so that it is documented.

- Use buttons 1 and 2 to go to another circuit that needs to be changed and repeat Step D.
- Press and hold buttons 1 and 5 until the **VIEW VALUE** LED lights.

**Note:** The Circuit Selector's display will go out automatically 20 minutes after the last button press.

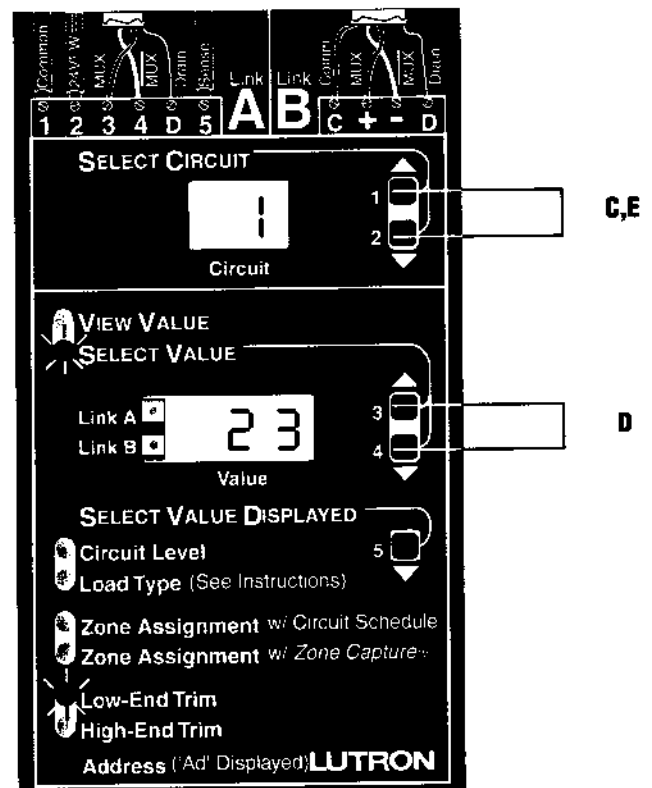
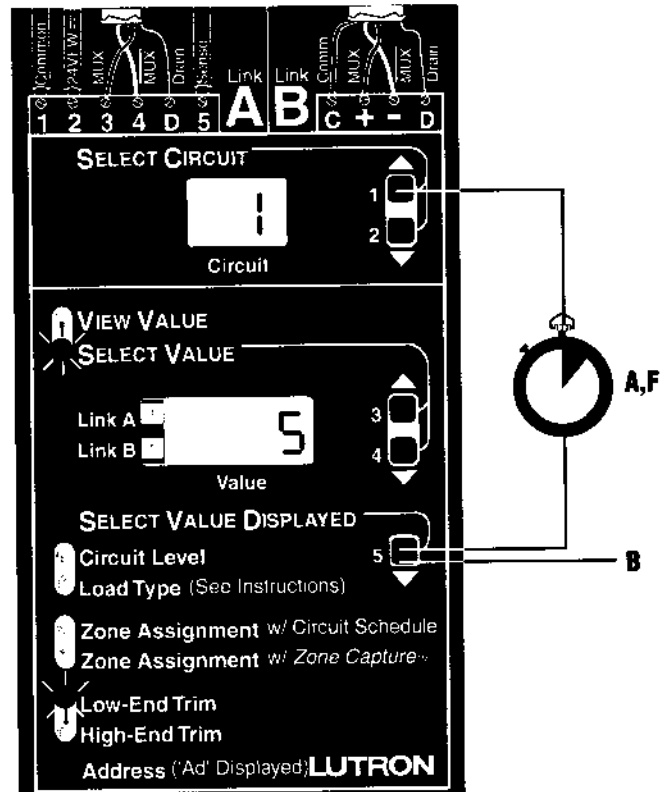



# Set Normal/ Emergency Switch

## STEP 17: Set Normal/Emergency Switch (Non-Essential/Essential)

**Note:** This step is only performed if there are any panels with Emergency (Essential) Lighting Circuits on the job.

Panels are shipped with Switch 6 (located at the base of each Circuit Selector) in the center position for operation without any Emergency (Essential) Lighting Circuits.

Identify a panel supplied with Normal (Non-Essential) power. Move its Switch 6 to the left position.

For all the Emergency (Essential) Lighting Panels, move Switch 6 to the right position.

In this arrangement, the Emergency (Essential) Lighting Panel will "sense" the Normal (Non-Essential) Panel's power. When Normal (Non-Essential) power is removed, the Emergency (Essential) Lighting will go to 'ord' override levels (factory set to 100%).

Loss of Normal (Non-Essential) power can be simulated by turning off all connected Normal (Non-Essential) Panel's Control Breakers.

When Switch 6 is in its center position (as shipped), terminal 5 has no affect on the Circuit Selector operation.

### Notes:

- If there is no Normal Panel, a PS-CIP can be used to create an external 'sense' line. Contact *Lutron*.
- Override ('ord') Level is factory set to full output (100). If less than full output is needed, contact *Lutron*.

### Circuit Selector in Normal (Non-Essential) Panel

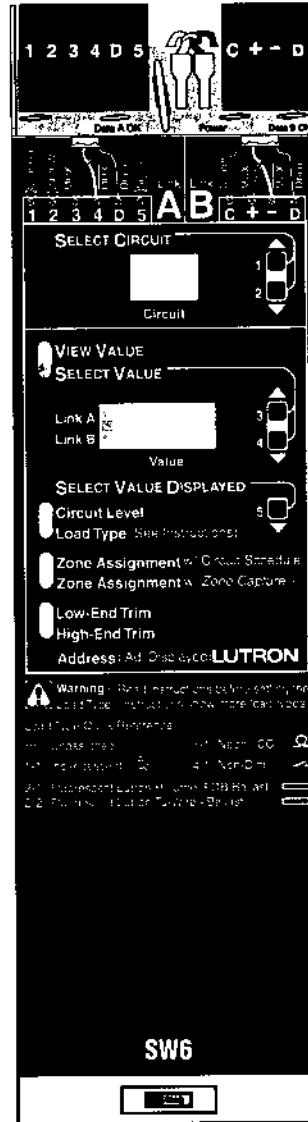

←  
**Move left**

### Circuit Selector in Emergency (Essential) Lighting Panel

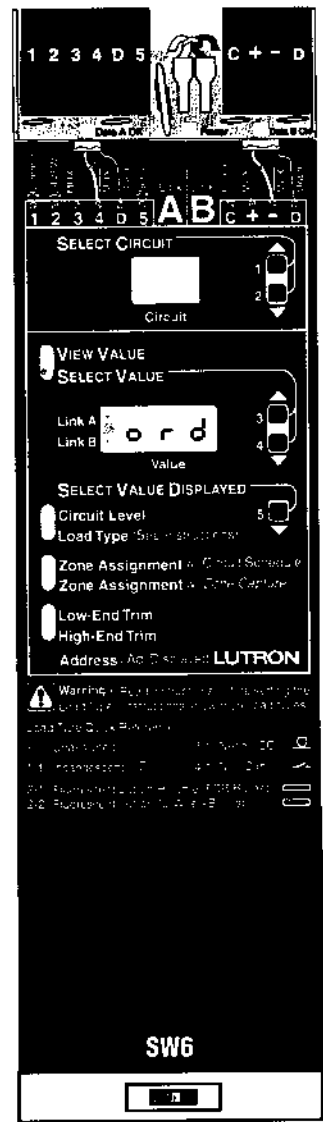

→  
**Move right**



# Set Up Scenes on the GRX-4000

## STEP 18: Set up scenes on GRX-4000

Scenes are the preset light levels and fade times stored in the Control Unit. To create a scene, set the appropriate intensity for each ZONE. To recall a scene, simply press one of the scene buttons. The first button recalls scene 1; the second, scene 2; and so on. The last button turns lights off.

For example, typical scene settings for a living room might be:

Scene	Activity or Event	Light Levels for Zones			Scenes
		Cove Lights	Hanging Lights	Down Lights	
1	Family Gathering	70%	10%	20%	20%
2	Entertaining	80%	25%	90%	90%
3	Reading	10%	80%	40%	40%
4	TV	20%	0%	30%	30%

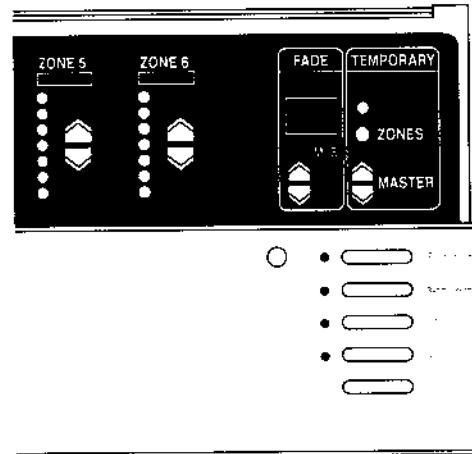

Although scenes 1 through 4 can be selected at the *GRAFIK Eye* Control Unit, all *GRAFIK Eye* Control Units are capable of storing up to 16 scenes. Scenes 5 through 16 can be selected using Wallstations.

## How to set up lighting scenes

**NOTE:** The Control Unit must be in normal operating mode.

To set up scenes 1 through 4:

- 1. Select a scene.** Press the Scene button for the scene you want to adjust. (First button for scene 1, second button for Scene 2, and so on.) Note that the last button is the "Off" Scene. You do not set intensities for this button.
- 2. Set each zone's light levels.** Press ZONE ▲ and ▼ to adjust each ZONE visually to the correct intensity for this scene. (ZONE LEDs show intensity. Each LED represents ~15% intensity change. In this example, ZONE 6 is set to 60%.)
- 3. Set scene's FADE-in time.** Press FADE ▲ and ▼ to make FADE-in time anything from 0-59 seconds or 1-60 minutes\*. (A scene's FADE-in time is how long it takes light intensities to adjust to their new levels when the scene is selected. FADE-in from the OFF scene can be up to 5 seconds maximum.)

Repeat this process for each scene specified for the Control Unit. Note that you can also set up a "FADE-to-off" time. Press the OFF button and adjust FADE as desired.

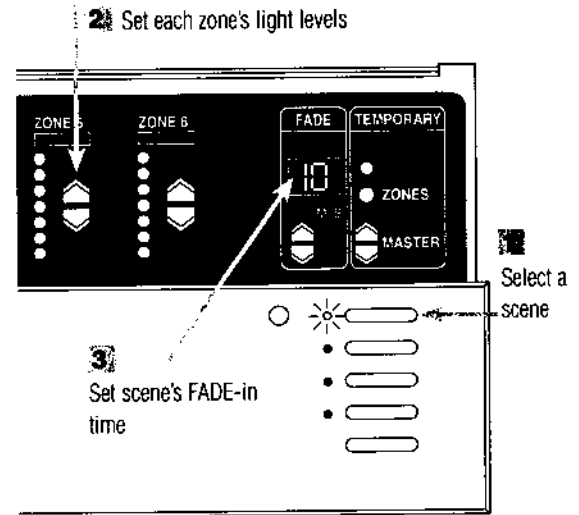

\*The S and M indicators under the FADE window show whether FADE is "M"inutes or "S"econds. To set FADE in minutes, you press FADE ▲ to scroll through 1-59 seconds until the 'M' lights. FADE is now expressed in minutes. To get back to seconds, press FADE ▼ until the window shows "S"econds.



## STEP 19: Set Up Wallstations









All Wallstations (except NTGRX-1S) must be set up to make a Control Unit(s) "listen" to button presses on the Wallstation.

- Only one Wallstation can be set up at one time.
- A Control Unit can also be made to "listen" to another Control Unit and is therefore listed with the Wallstations below.

Follow the following chart for each Wallstation.

### Notes:

- Wallstations **cannot** be made to "listen" to each other, but a GRX-4000 Series Control Unit can be made to "listen" to more than one Wallstation.
- When it is desired for two GRX-4000 Series Control Units to always respond to each other's button presses, the first Control Unit must be set-up to respond to the second Control Unit's buttons, and then the second Control Unit must be set up to respond to the first Control Unit's buttons.
- An NTGRX-1S is wired directly to the GRX-4000 (GRX-3000) Series Control Unit that is to "listen" to it. No setup is required. Certain GRX-3000 2-Zone Series Control Units do not have the SSA capabilities. See pg. 41, "SSA," for more details.
- GRX-PRG and GRX-RS232 do not require this setup.

Control (only 1 at a time)	Place Control to 'Talk' in Set-Up Mode
GRX-4000 Series Control Unit 	Press and hold first and the fifth buttons of the GRX-4000 Series Control Unit.
NTGRX-4S NTGRX-4S-IR GRX-4S-DW 	Press and hold first and fifth buttons on Wallstation until its LEDs cycle sequentially. <b>Note:</b> GRX-CIR only has 1 LED. Use the GRX-IT to press the first and fifth buttons.
GRX-CIR w/GRX-IT/81T 	
NTGRX-4B 	Press and hold first and fourth buttons on Wallstation until its LEDs cycle sequentially.
NTGRX-4PS 	Press and hold first and fifth buttons until LED 1 blinks.
NTGRX-4M 	Press and hold first and fifth buttons until LED 1 blinks.
NTGRX-2B-SL Partition Status Control 	Press and hold both buttons of the NTGRX-2B-SL until its LEDs blink.
NTGRX-2B-SL all other functions 	Press and hold both buttons of the NTGRX-2B-SL until its LEDs blink.
GRX-AV 	Press and hold the Program Switch until its LEDs react like the Wallstation whose function is being simulated.





# Wallstations and Control Interfaces

	<b>Make Control Unit "Listen"</b>	<b>Take Control Out of Set-Up Mode</b>
	Press and hold another Control Unit's Scene 1 button until its LEDs flash. To make it stop "listening", hold OFF button until LEDs go dark.	Press and hold first and fifth buttons of the original GRX-4000 Series Control Unit until LEDs stop sequencing.
	Press and hold Scene 1 on a Control Unit until its LEDs blink in unison. Repeat Scene 1 hold procedure for the other Control Units to be affected. (To remove, hold OFF button until LEDs go dark)	Press and hold first and fifth buttons on Wallstation until all LEDs stop cycling.
	Press and hold Scene 1 on a Control Unit until its LEDs flash. To make it stop "listening", hold OFF button until LEDs go dark.	Press and hold first and fourth buttons on Wallstation until all LEDs stop blinking
	Choose two Control Units on either side of a Partition. Press and hold Scene 1 on a Control Unit until its LEDs flash. Repeat Scene 1 hold on the other Control Unit. Press the next button on the NTGRX-4PS. Choose another pair of Control Units. Repeat Scene 1 hold procedure for each of the NTGRX-4PS buttons. To remove, hold OFF button on each Control Unit until LEDs go dark.	Press and hold first and fifth buttons of the NTGRX-4PS until all LEDs stop blinking.
	Choose a Control Unit to be toggled by the NTGRX-4M. Press and hold Scene 1 on the Control Unit until its LEDs flash. Repeat Scene 1 hold on other Control Units to be toggled. Press the next button on the NTGRX-4M. Choose a Control Unit to be toggled. Repeat Scene 1 hold procedure for all 5 of the NTGRX-4M buttons. Button 5 only turns ON or OFF (it does not toggle). To remove, hold OFF button on the Control Unit until its LEDs go dark.	Press and hold first and fifth buttons of the NTGRX-4M until all LEDs stop blinking.
	Choose two Control Units on either side of a Partition. Press and hold Scene 1 on a Control Unit until its LEDs flash. Repeat Scene 1 hold on the other Control Unit. To remove, hold OFF button on each Control Unit until LEDs go dark.	Press and hold both buttons of the NTGRX-2B-SL or until all LEDs stop blinking.
	Press and hold Scene 1 on a Control Unit until its LEDs blink in unison. Repeat Scene 1 hold procedure for the other Control Units to be affected. To remove, hold OFF button until LEDs go dark.	Press and hold both buttons of the NTGRX-2B-SL or until all LEDs stop blinking.
	See above instructions for the simulated Wallstation.	If the GRX-AV's LEDs are sequencing, press and hold the Program Switch until the LEDs stop sequencing. If the GRX-AV has 1 LED blinking, press the program switch repeatedly until there are no blinking LEDs.

**Repeat for all Wallstations**

---

# Congratulations!

Your state of the art lighting control system is complete!

Now:

- Place a copy of the Control Directory with each LP Panel.
- Give the customer a copy of this guide.

The rest of this guide is  
REFERENCE MATERIAL.

Lutron is very interested in your comments on this Installer's Guide and on its products. Please call ++81-3-5405-7333 with any comments or suggestions. Thank you for your help.



# Save Options

# Reference Sheet



The *GRAFIK Eye* 4000 Series Control Units allow selection of several different Save Options. Follow these steps to access the Save Options.

1. **Enter setup mode.** Press and hold Scene 1 and OFF buttons for about 3 seconds until scene LEDs start cycling.
2. **Select Sd.** Press FADE ▲ until Sd is displayed in the FADE window.
3. **Select Save Options.** Press MASTER ▲ and ▼ to select between the Save Options:

- Sd **Save by Default.** Changing a zone's intensity level or fade time permanently changes the preset scene. To temporarily change a light level, see "How to adjust light levels temporarily" on page 8.
  - Sb **Save by Button.** TEMPORARY ZONES LED is normally ON and all intensity and fade changes are temporary unless the TEMPORARY ZONES LED is turned OFF with the TEMPORARY ZONES button.
  - Sn **Save Never.** TEMPORARY ZONES LED is permanently ON and cannot be turned OFF. In this mode, all intensity changes are temporary.
  - 45 **Four Scenes.** This only allows the four Scene buttons, OFF button, IR receiver and the MASTER ▲ or ▼ to operate. All other buttons on the Control Unit are disabled.
  - bd **Button Disable.** All buttons on the Control Unit are disabled. IR Receiver, and Wallstations are still functional. (Setup mode is still accessible by repeating Step 1.)
4. **Exit setup mode.** Press and hold Scene 1 and OFF buttons until scene LEDs stop cycling.

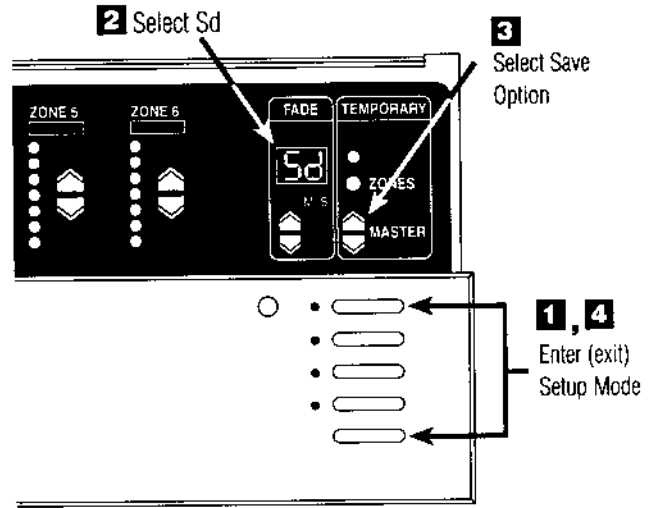

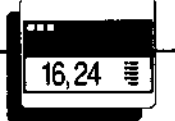

## GRX-4116/4516 and GRX-4124/4524 Control Units

The 16 and 24 zone *GRAFIK Eye* Control Units offer an expanded number of zones that can be controlled from a single wall station. The zone intensity LEDs on the GRX-4x16 or GRX-4x24 will display the light level of eight zones at a time. Other sets of zones may be displayed and controlled by pressing the Zone Select Button.

### Addressing

The GRX-4x16 and the GRX-4x24 Control Units take multiple, consecutive addresses. The GRX-4x16 Control Unit takes up two consecutive addresses, and the GRX-4x24 Control Unit requires three. To ensure there are sufficient addresses available, any GRX-4x16 and/or GRX-4x24 Control Units in the system should be addressed first.

### Assigning Zones

When assigning zones use the chart on the right as a guide to see how zones are displayed on the Circuit Selector.

**Note:** The chart at right is for a GRX-4x24, which uses three addresses. A GRX-4x16 will have two addresses.

### Zone Select Button

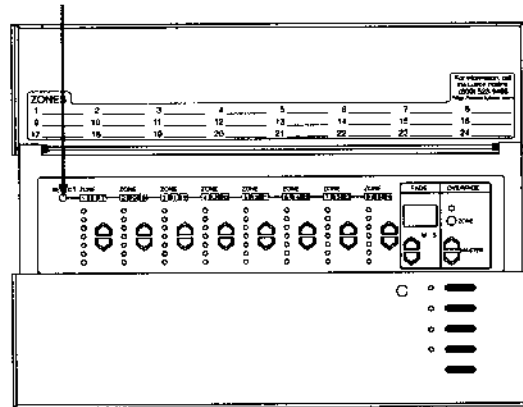

GRX-4124 Control Unit

If Control Unit's Addresses are . . .	Zones on the Control Unit . . .	Will appear on the Circuit Selector . . .
A1, A2, A3	1—8 9—16 17—24	A11—A18 A21—A28 A31—A38
A2, A3, A4	1—8 9—16 17—24	A21—A28 A31—A38 A41—A48
.	.	.
.	.	.
.	.	.
.	.	.
A6, A7, A8	1—8 9—16 17—24	A61—A68 A71—A78 A81—A88



## Control Directory - GRX-4000 Series Control Unit

Area:		Area:		Area:		Area:	
A1		A2		A3		A4	
Zone	Zone Description	Zone	Zone Description	Zone	Zone Description	Zone	Zone Description
A1	1	A2	1	A3	1	A4	1
A1	2	A2	2	A3	2	A4	2
A1	3	A2	3	A3	3	A4	3
A1	4	A2	4	A3	4	A4	4
A1	5	A2	5	A3	5	A4	5
A1	6	A2	6	A3	6	A4	6
A1	7	A2	7	A3	7	A4	7
A1	8	A2	8	A3	8	A4	8

Area:		Area:		Area:		Area:	
A5		A6		A7		A8	
Zone	Zone Description	Zone	Zone Description	Zone	Zone Description	Zone	Zone Description
A5	1	A6	1	A7	1	A8	1
A5	2	A6	2	A7	2	A8	2
A5	3	A6	3	A7	3	A8	3
A5	4	A6	4	A7	4	A8	4
A5	5	A6	5	A7	5	A8	5
A5	6	A6	6	A7	6	A8	6
A5	7	A6	7	A7	7	A8	7
A5	8	A6	8	A7	8	A8	8

Use this Directory as GRX-4000 Series Control Units are addressed and zones are assigned. Keep this Directory for job records and maintenance information.



## Circuit Selector Functions

There is a Circuit Selector in every Lighting Control Panel. It is used to communicate with GRX-4000 Series Control Unit(s), G6000 controller, or DMX512 stageboards – and then to tell the dimmers their intensity levels.

It is also used to select Values for each Circuit:

- **Circuit Level** - allows a way to view the intensity being sent to the dimmer or manually take over control of the dimmer's output. See description in the Troubleshooting Reference section.
- **Load Type** - to be changed to match the load to the Load Type value. Non-Dim Load Type 4-x must be used if the Load is not dimmable.
- **Control and Zone Assigned** - allows two ways of assigning a control and zone to a specific circuit.
  1. 'w/ Circuit Schedule' allows a Control and Zone (such as 'A2', '3') to be directly entered into the Circuit Selector.
  2. 'w/ Zone Capture™' allows a Control and Zone to be 'captured' by the Circuit Selector by doing the following:
    - A. Press and hold buttons 1 and 5 until the **SELECT VALUE** LED lights.
    - B. Press button 5 repeatedly until the **Zone Capture™** LED lights. The circuit will now flash.
    - C. Use buttons 1 and 2 to choose the correct circuit to be assigned.
    - D. Go to the GRX-4000 Series Control Unit to be assigned to this circuit.
    - E. Select Scene 1.
    - F. Identify the zone to be assigned to this circuit.
    - G. Press the zone ▼ button until all zone LEDs are off.
    - H. Press the zone ▲ button until the load starts tracking the zone intensity LEDs.
    - I. Press the zone ▼ button until all zone LEDs are off. (Steps H. and I. must take less than 15 seconds or the Circuit Selector will not lock on the captured zone.)
    - J. Go back to the Circuit Selector and the proper Control and Zone should be displayed. Repeat this process for any other Circuits.
    - K. Press and hold buttons 1 and 5 until the **VIEW VALUE** LED lights.
- **Low and High End Trims** - allows the Circuit's range limits to be adjusted.

'Power OK' indicates whether 24VAC is present from the Class 2 transformer.

'Data OK' LED(s) blink when the Circuit Selector is properly receiving data.

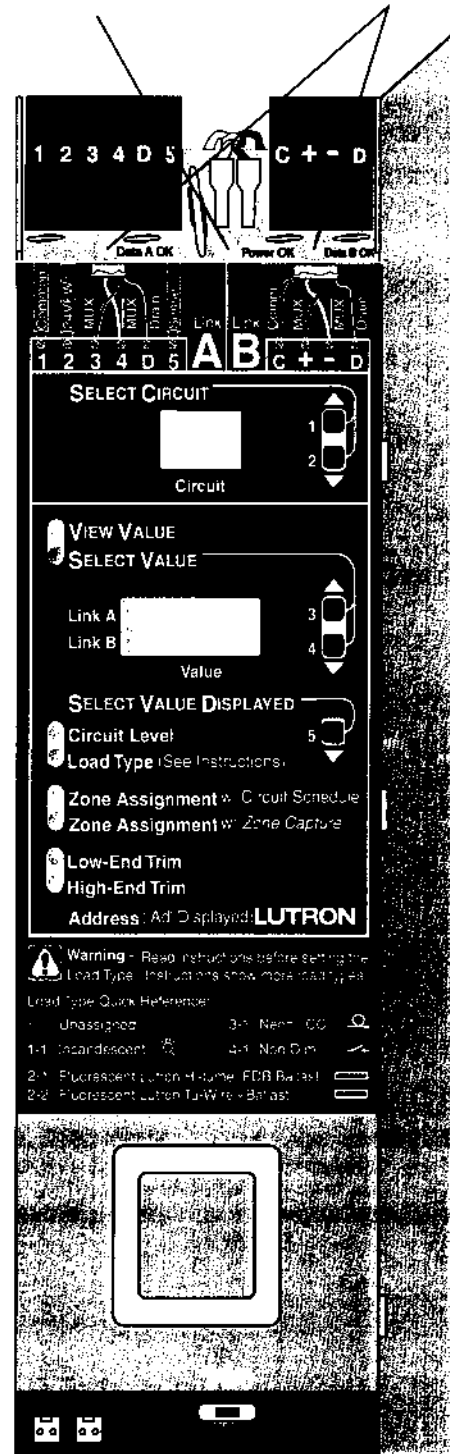

The Circuit Selector can also provide or receive a 'sense' line depending on the location of Switch 6 (SW6).



# Circuit Selector Address

# Reference Sheet



## Assign Address to Circuit Selector

Address the Circuit Selector whenever it is to talk to a G6000 Controller or GRX-4500 Series Control Unit.



**Caution!** Assigning an improper address to the Circuit Selector can result in damage to the load.

- A. To set or change the address, press and hold buttons 1 and 5 until the **SELECT VALUE** LED flashes once per second.
- B. Press button 5 on circuit selector until "Ad" is displayed in the **Circuit** window.  
If the **Value** window displays an address other than '-', the address has already been set (proceed to Step D).
- C. Use button 3 or 4 to assign an address (1—512) to the Circuit Selector. This address should match the address in the job drawing.
- D. Press and hold buttons 1 and 5 on the Circuit Selector until the **VIEW VALUE** LED lights.

### Notes:

- The **Value** window will display the software revision level of the Circuit Selector 20 minutes after the last button press.
- Panel addressing must be completed prior to transferring data from LIAISON™ or the GRAFIK 6000® controller.
- Mark addresses on a Circuit Directory for future reference.
- If 'LC' is displayed in the Circuit window, the circuit selection is locked out. Contact the *Lutron* Field Service Department.



**Warning:!** Each LP Panel must have a unique, specific address. See *Lutron's* Load Schedule, Cabinet Detail Report, or user setup software.

## Circuit Selector

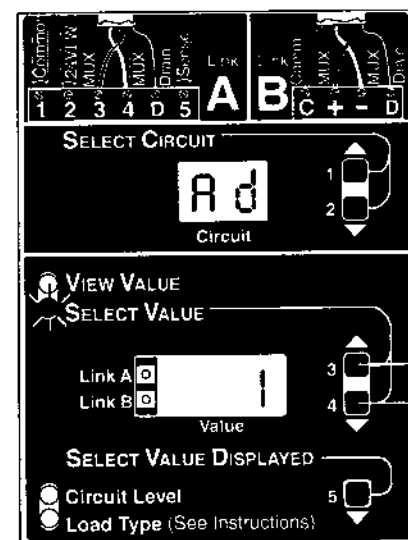
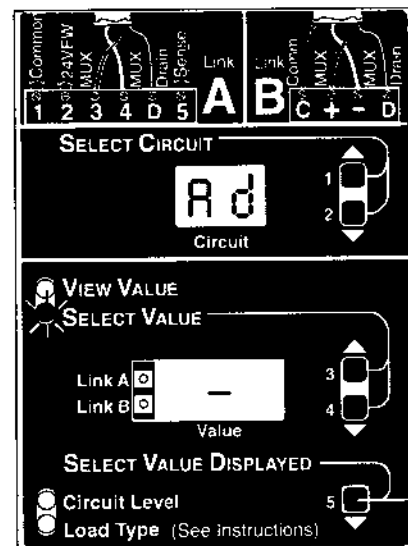
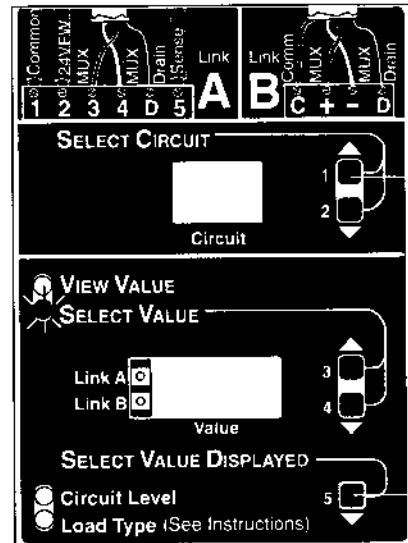



## Assign Link Hierarchy (2Link only)

Link Hierarchy is only used when there are two control links. Each circuit can be assigned to a hierarchy listed below (see job prints if predetermined)

If you are not sure if you have a 2Link Circuit Selector, please call the Lutron Technical Assistance Hotline at 1-800-523-9466.

Code	Definition	Primary Link	Secondary Link	Application Example
A	Link A only.	A	None	Circuit to follow Link A (standard operation).
b	Link B only.	b	None	Panel is shared by two links to save on Panel costs.
A1	Link A unless Link B is present.	A	b	When the DMX-512 Stageboard is plugged in on Link B, listen to Link B. Return to Link A when the DMX-512 Stageboard is unplugged.  Redundant system. If Link B fails, circuits follow Link A.
A2	Link A unless Link B is present and Zone X intensity on Link B is >50%.	A	b	DMX-512 Stageboard is plugged in on Link B, but does not take control until the light intensity of Zone X on Link B is above 50%.
b1	Link B unless Link A is present.	b	A	Redundant system. If Link A fails, circuits follow Link B.
b2	Link B unless Link A is present and Zone X intensity on Link A is >50%.	b	A	DMX-512 Stageboard plugged in on Link B, but is not given control until the light intensity of Zone X on Link A is below 50%.
Ab1	Highest intensity of the zone assignments of Link A and Link B.	A	b	Redundant system. If either Link A or Link B fails, the other will have higher intensities.
Ab2	Lowest intensity of the zone assignments of Link A and Link B.	A	b	Energy management.



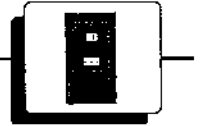

## Assign Link Hierarchy (continued)

- A. To view or assign the Link Hierarchy, press and hold buttons 2 and 5 until **SELECT VALUE** LED flashes twice repeatedly.
- B. Press button 5 until the **Circuit Level** LED lights.
- C. Use buttons 1 and 2 to choose circuit number.
- D. Use buttons 3 and 4 to assign the Link Hierarchy (see Table for options).
  - If Link Hierarchy A or b is selected, go to Step I.
  - If Link Hierarchy A2 or b2 is selected, go to Step E.
  - If Link Hierarchy A1, b1, Ab1, or Ab2 is selected, go to Step G.
- E. Press button 5 until **Load Type** LED lights.
- F. Select Zone X

**4000 Series on Secondary Link:** Press button 3 or 4 to select both Control Unit and zone assignment. Example - If the control desired is addressed to 'A2' and the zone desired is the 3rd from the left, use buttons 3 and 4 to get 'A23' as a value for the appropriate circuit.

**6000 Series or DMX512:** Press button 3 or 4 to select zone assignment (1—512).

- G. Press button 5 until the **Zone Assignment w/Circuit Schedule** LED lights.
- H. Select the Secondary zone assignment.

**4000 Series on Secondary Link:** Press button 3 or 4 to select both Control Unit and zone assignment. Example - If the control desired is addressed to 'A2' and the zone desired is the 3rd from the left, use buttons 3 and 4 to get 'A23' as a value for the appropriate circuit.

**6000 Series or DMX512:** Press button 3 or 4 to select zone assignment (1—512).

**Note -** Primary Zone assignment is done in Step 14 of this guide.

- I. Repeat steps C and D for **each and every** circuit to be changed.
- J. Press and hold buttons 1 and 5 until **VIEW VALUE** LED lights.

## Circuit Selector

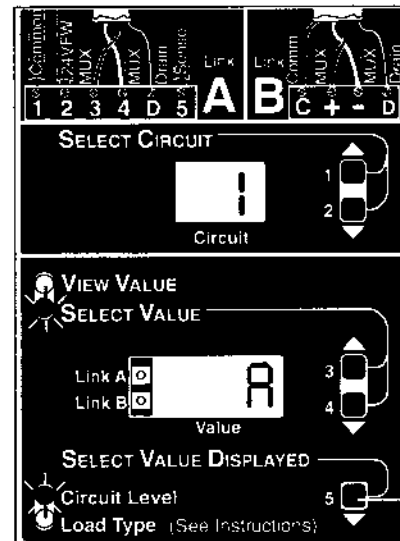
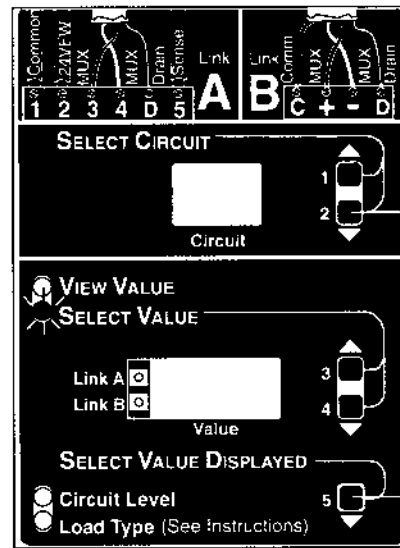

B

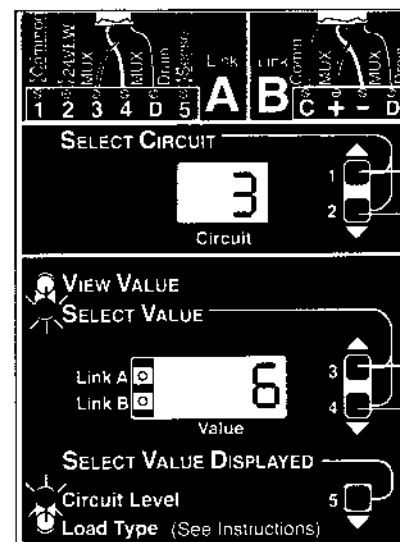

C

D



## XP/LP Combination Panel

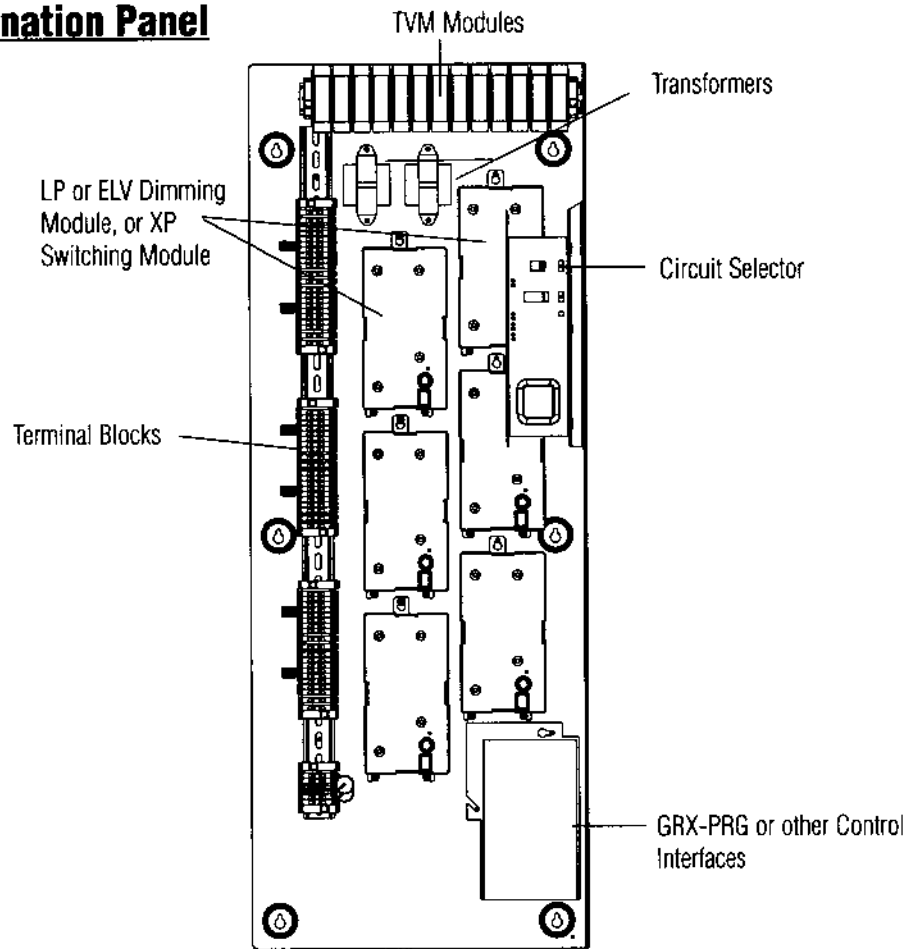

## XP 4 - 48 (XP-24 shown)

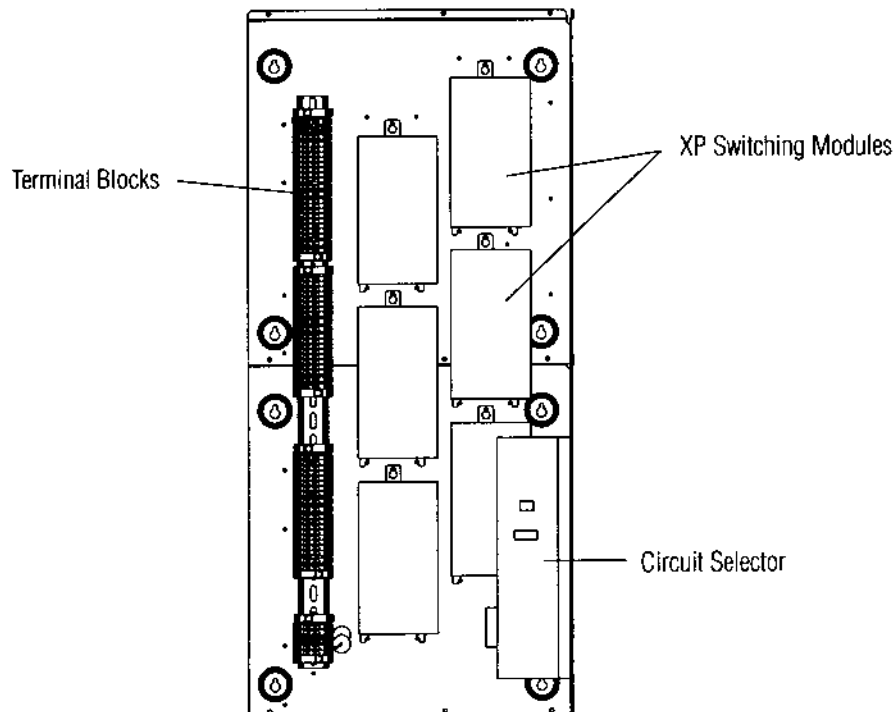

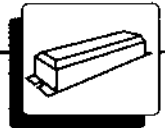

## Ballast and Fixture Wiring

### One Lamp

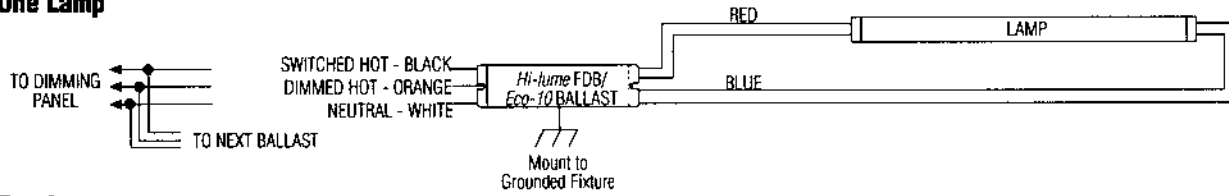

### Two Lamps

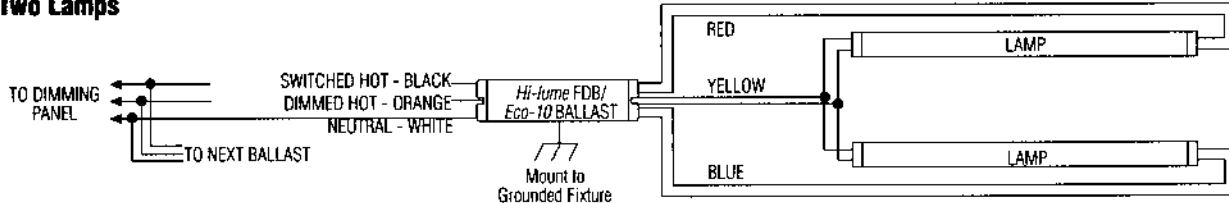

### Notes:

- Ballasts must be located so that the maximum case temperature is less than 75 °C (167 °F) and the relative humidity is less than 90%, non-condensing.
- Avoid situations where strong air drafts blow directly on bare bulbs (minimum start temperature is 10 °C).
- Good metal-to-metal contact between lamp pins and lamp holder contacts is necessary for proper dimming performance. Knife-edge sockets are recommended.
- 240V Ballasts have different wire colors-follow the label on each individual ballast.
- Compact Fluorescent lamps must be 4 pin.
- Ballast cases and fixtures must be earth grounded.
- Ballasts are not designed for remote mounting. Total length of wire from the ballast to the lamp socket is not to exceed 7 ft. (2.1 m) for T8, T12, and not to exceed 3 ft. (0.9 m) for T4, T5.

## Check Installation

Use the following table to determine if the lamp sockets in the fixture need to be replaced. (Linear and 4-Tube lamps)

Existing Ballast(s) Information		How to prepare the existing fixture for <i>Lutron</i> Dimming Ballasts.
Number of Lamps per ballast	Total number of wires coming out of the ballast	
1	5 or FEWER	Replace the lamp sockets with Rapid Start sockets.
	6 or 7	Using the existing sockets, and the existing wires.
2	7 or FEWER	Replace the lamp sockets with Rapid Start sockets.
	8 or 9	Using the existing sockets, and the existing wires.

**Note:** When replacing sockets, use Rapid Start sockets. (A knife-edge variety, such as model #13053-UN by Leviton Mfg. Co., or a #660 Series by Triboro Mfg. Co., is recommended.)

Many fluorescent lamp sockets are available with mounting slots to vary the height of the lamp away from the grounded metal surface. Use these slots to get the outside edge of the lamp to be 1/2" (12.7 mm) ± 1/4" (6 mm) away from the grounded metal surface.

Having a fluorescent lamp too close to the grounded metal will make the minimum intensity too low and will reduce lamp life.

Having a fluorescent lamp too far away from the grounded metal will make the lamp flicker or not turn ON at all.

A Rapid Start, one-lamp ballast will normally have 6 wires – (1) Hot, (1) Neutral, (4) lamp wires. A 7th wire, the Ground, may be present depending upon the manufacturer. New sockets are not required when this type of ballast is replaced with a *Lutron* ballast.



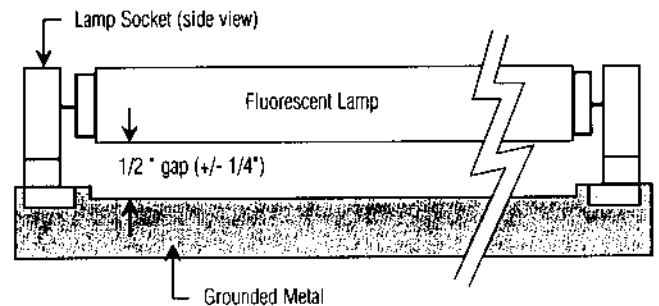

**Warning!** Operating *Lutron* Dimming Ballast(s) with the wrong sockets in place will damage the ballast(s) and void the warranty.





## Troubleshooting Guide

Symptom	RPM LED 	Circuit Selector		Circuit # Display	GRX LEDs 	Possible Cause/Solutions
		'Power OK' LED	'Data OK' LEDs			
Normal Operation as Reference	"Heartbeat" (~1 per sec)	On	"Heartbeat" (~1 per sec)	OK	OK	All LEDs show OK, see below for other suggestions
				OUT	OK	Push any button on Circuit Selector (display turns off in 20 minutes)
				"LC"	OK	Circuit Selector Locked out
All dimmers controlled by 1st zone	"Heartbeat" (~1 per sec)	On	"Heartbeat" (~1 per sec)	OK	OK	Circuit Selector not set up - see instructions for zone assignment.
All Dimmers on FULL or OFF only	"Heartbeat" (~1 per sec)	On	"Heartbeat" (~1 per sec)	OK	OK	Circuit Selector not set up - see instructions for Load Types.
No Dimming - Always Full	"Flutter"* (~5 per sec)	On	"Heartbeat" (~1 per sec)	OK	OK	Dimmer in Bypass - remove Bypass Jumper after loads have been proven Dimmer defective - contact <i>Lutron</i>
No dimming - Level Frozen	"Light House" (~1 per 7 sec)	On	"Heartbeat" (~1 per sec)	OK	OK	2-wire Panel Control Harness disconnected at the bottom of the Circuit Selector
		On	"Flutter"* (~5 per sec)	OK	OK	Wiring of Terminals 3 and 4 flipped. GRX connector unplugged at Control Unit.
	ON continuously	N/A	N/A	N/A	N/A	Dimmer circuitry locked up. Turn off circuit breaker to reset the dimmer. Notify <i>Lutron</i> . Wrong Baud Rate—Notify <i>Lutron</i> .
Controls Dead	"Light House" (~1 per 7 sec)	On	Off	OK	Off	<i>GRAFIK Eye</i> Control Units not addressed. Miswire to control link wires 1, 2, 3, and 4
		On	Off	OK	OK	No data on Control Link open wires 3 or 4
		Off	Off	OK	Off	Miswire shorting 24VFW (Terminal 2) to Common (Terminal 1) or ground
		Off	Off	Out	Off	Control Breaker Off

\* An accurate "Flutter" rate requires that the circuit be cycled OFF, then ON to high end from the appropriate Control Unit.



## Troubleshooting Guide (continued)

After checking LED diagnostics, use this chart:

Symptom	Possible Cause/Solutions
Wallstations will not go into Set Up Mode	GRX-4000 Series Control Units are not addressed. Terminals 3 and 4 miswired.
Fluorescent Load Flickers	DIM HOT and SW HOT wires crossed. Low End set too low.
Panel is Warm	This is probably normal. Solid-state controls dissipate about 2% of the connected load as heat. Make sure panel has adequate venting. Areas above and below the panel allow air to flow behind the panel to cool it.
Two Control Units have the same Address (usually A1)	One of the units has wires 3 and 4 crossed or open. Wire terminal 3 to terminal 3, 4 to 4.

**Note:** The following voltages should be present on the GRX wiring:

Terminals 2 to 1 ≈ 22VDC

Terminals 3 to 4 ≈ 3VDC

Terminals 5 to 1 if Switch 6 set for Normal ≈ 22VDC

### Other Troubleshooting tools:

The Circuit Selector can be used to view the intensity information being sent to the dimmer. Use buttons 1 and 2 on the Circuit Selector to access the circuit Number desired. Press button 5 repeatedly until the **Circuit Level** LED lights. Value displayed is now the present intensity sent from either Link A or Link B (as indicated) that is controlling that circuit. Value = 0 is OFF, Value = 100 is ON full.

The Circuit Selector can also be used to manually change the intensity of the desired circuit. Press and hold buttons 1 and 5 until the **SELECT VALUE** LED lights. Use buttons 1 and 2 to access the circuit desired. Press button 5 repeatedly until the **Circuit Level** LED lights. Buttons 3 and 4 will now control the desired circuit.

Value = 0 is OFF, Value = 100 is ON full, Value = CF is Circuit Finder - load will blink for easy location.

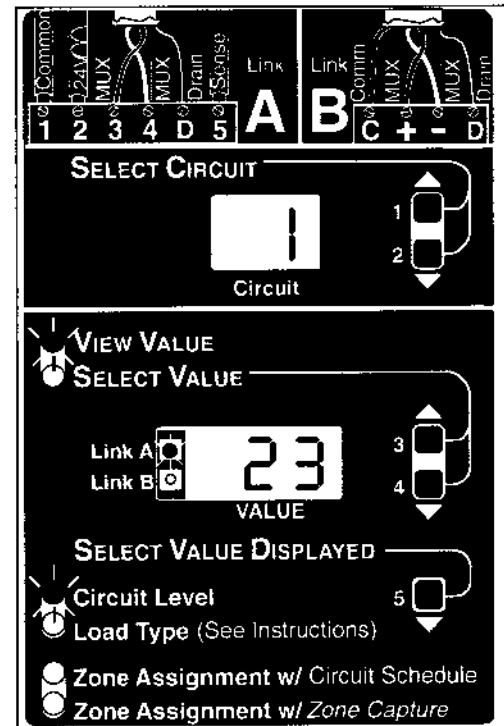



## Maintenance

### GRX-4000 Series Control Units and Wallstations

Clean front surface of control with a soft towel moistened with a mild soap solution (non-ammonia-based). Clean approximately every six months.



**Caution!** Do not spray cleaning solution onto control as it may reach internal components.

### LP Panels

1. Clean any dirt from air vent openings with a vacuum and check for any obstructions which may block air flow. Keep 12" (30.5 cm) above and below panels unobstructed.
2. If any extra wiring is brought into the power panel, thoroughly remove all metal chips, wire strands, insulation and other debris before reapplying power.
3. In the unlikely event of damage to dimming equipment, turn off breakers, replace bypass jumpers and turn on breakers. This will apply full power to fixtures.

### Fluorescent Fixtures

1. It is important that lamps are maintained properly to prevent what may appear as dimming equipment malfunctions. When lamps begin to fail on a circuit, *Lutron* recommends group relamping of the entire circuit.
2. **New fluorescent lamps must be "seasoned" for dimming applications by operating at full intensity for their first 100 hours.**

Leave the lamps at full intensity for 100 hours. Although this may be inconvenient, it is necessary for good dimming performance, and achieving normal lamp life.



**Warning!** For proper dimming performance fluorescent lamps must be operated at full intensity for 100 hours prior to dimming.

### Why keep the lamps at full intensity for 100 hours?

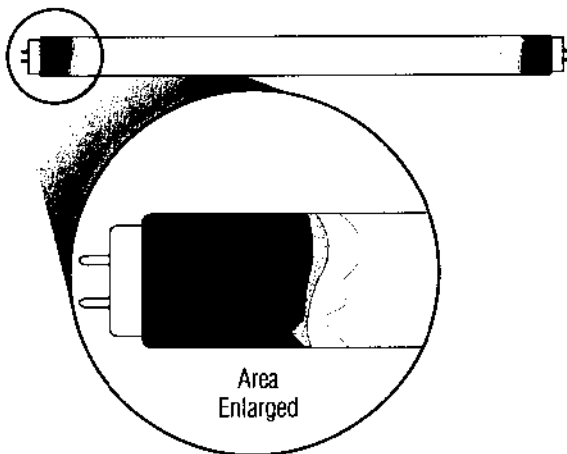

Lamp that was **NOT** seasoned for 100 hours.

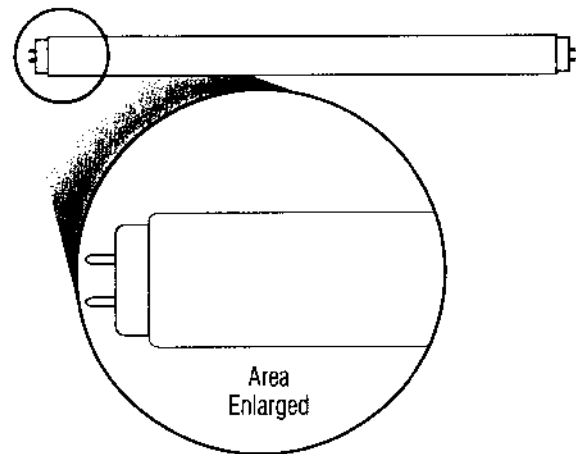

Lamp that **WAS** seasoned for 100 hours.

New fluorescent lamps have impurities in them which lamp manufacturers cannot eliminate completely. Lamps must be operated at full intensity for 100 hours **before dimming** to neutralize the harmful effects of these impurities. Without the 100 hours at full intensity, the impurities may cause the lamp to fail within a week (or failure may take months depending on usage and the amount of impurities).

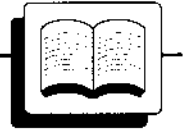

**2Link** - an option feature on a Circuit Selector that allows a circuit within a Lighting Control Panel, to be assigned to any zone on either Control Link A or Control Link B. The choice of Link Hierarchy determines which Link's intensity level is sent to a specific circuit.

**Accessory Control** - former term for both a Wallstation and Control Interface. This term was separated to more clearly distinguish between the two types of controls.

**Addressing** - a way for the controls on a link to identify each other. Wallstations are addressed, using switches 1 through 4 on the back of each control. Each control needs a unique address. GRX-4000 Series Control Units are addressed while in Set-Up Mode from the front panel's buttons.

**Circuit Selector** - the interface between the Control Link(s) and the digital dimmers that reside in a GP panel. The Circuit Selector houses all Circuit Values including Load Type, Control and Zone assigned, and Low End and High End light levels. *2Link* is available as an option or upgrade.

**Control Interface** - *GRAFIK EYE* control wired to a GRX-4000 (or GRX-3000) Series Control Unit to select scenes, raise and lower specific zones or other functions on an attached Control Unit. An external closure or a computer typically activates these functions.

**Control Link** - the daisy-chained link of controls wired to the Circuit selector. A Control Link can be a) GRX-3000/4000, b) G6000, or c) DMX-512.

**Dimmed Hot (DH)** - a variable output from each circuit. This output must be used for all Non-Dim Load Types to ensure full lifetime of the dimmer's relay closure. The output limits and characteristics are set by the Load Type.

**Fade** - a gradual change in light intensity in a room or space.

**Fade Time** - selected time interval to change from one scene to another. A GRX-4000 (and GRX-3000) Series Control Unit has a customer-adjustable fade time that ranges from 0-59 seconds and 1 to 60 minutes.

**High End** - the light level when a circuit output is at its highest intensity. The High End can be trimmed to a brighter or dimmer level. High End is usually set for lamp life and energy savings.

**Link Hierarchy** - a value that must be set when using the *2Link* option on the Circuit Selector. This value determines when either Link A or Link B controls the output of any circuit within the Control Panel.

**LED (Light Emitting Diode)** - an illuminated indicator to help in setting up and diagnosing GP Panel and GRX-4000 Series Control Unit's functions.

**Load Type** - a value in the Circuit Selector that defines the performance of the circuit to optimally control loads such as: Incandescent, *Hi-lume* FDB or *Eco-10* Dimmable Fluorescent, Neon, Non-Dim, Electronic Low Voltage.

**Low End** - the light level when a circuit output is at its lowest intensity (just above OFF). The Low End can be trimmed to a brighter or dimmer level. Low End is usually set for aesthetics.

**Non-Dim Load** - a source that is not to be dimmed. Load Circuit wiring is to be connected to the Dimmed Hot (DH) terminal and Load Type for that circuit is to be set to a Non-Dim Load Type only.

**RPM (Remote Power Module)** - a group of up to 4 dimmers in a module that can dim or non-dim various load types.

**RTISS™** - Real Time Illumination Stability System used to filter noise out of the power feed to each digital dimmer, resulting in a more stable output.

**Scene - (or Preset)** - Predetermined light intensity for one or more lights, creating a lighting effect that can be recalled by pressing a single button. The GRX-4000 Series Control Unit has Scene 1-4 and OFF accessible on the front of the control. Some Wallstations and Interface Controls can be Set-Up to access Scenes 5-16.

**SSA** - Single Scene Activator (model # NTGRX-1S) alternately toggles the GRX-4000 (GRX 3000) Series Control Unit, to which it is wired, between Scene 1 and OFF. The SSA is not counted as a Wallstation. Multiple SSA Wallstations can be wired in parallel controlling the same GRX-4000 Series Control Unit. SSA Wallstations do not work with GRX-3000 Series 2-Zone Control Units for the U.S. and Australia (*CE 2-Zone* version **does** have SSA).

**Switched Hot (SH)** - an unprotected relay closure from each dimmer. This output is used for *Hi-lume* FDB or *Eco-10* Fluorescent only.

**TVM** - a module capable of providing low-voltage control signals to various loads. Each module controls 2 consecutive circuits (1 & 2, 3 & 4, etc.). Control signals consist of 0-10V PWM conforming to IEC 929 and *Tridonic* DSI. Each circuit can sink or source up to 50 mA of control current (750 mA max. total per panel). The TVM module must be used in conjunction with Power Module (GP dimmer or 4U module) that switches power to the load.

**Wallstation** - *GRAFIK EYE* control wired to a GRX-4000 (or GRX-3000) Series Control Unit to select scenes, raise and lower specific zones or other functions on an attached Control Unit. Buttons typically activate these functions.

**Zone** - a fixture or a group of fixtures controlled simultaneously. The GRX-4000 Series Control Unit controls multiple zones (e.g., a GRX-4008 can control 8 zones). Each zone can be assigned to one or more Circuits in a GP Panel. Each zone should only control one Load Type.

**Zone Capture** - a method of Assigning a Control and Zone to a circuit without knowing Control Addresses. See 'Circuit Selector Functions' in the Reference Section.

Internet: [www.lutron.com](http://www.lutron.com)  
E-mail: [product@lutron.com](mailto:product@lutron.com)

**WORLD HEADQUARTERS**  
Lutron Electronics Co. Inc.,  
TOLL FREE: (800) 523-9466  
(U.S.A., Canada, Caribbean)  
Tel: (610) 282-3800;  
International 1-610-282-3800  
Fax: (610) 282-3090;  
International 1-610-282-3090

**GREAT BRITAIN**  
Lutron EA Ltd.,  
Tel: (171) 702-0657;  
International 44-207-702-0657  
Fax: (171) 480-6899;  
International 44-207-480-6899

**GERMANY**  
Lutron Electronics GmbH  
Tel: (309) 710-4590;  
International 49 309 710-4590  
Fax: (309) 710-4591;  
International 49 309 710-4591

**ASIAN HEADQUARTERS**  
Lutron Asuka Corporation  
Tel: (03) 5405-7333;  
International 81-3-5405-7333  
Fax: (03) 5405-7496;  
International 81-3-5405-7496

**HONG KONG SALES OFFICE**  
Lutron GL (Hong Kong)  
Tel: 2104-7733;  
International 852-2104-7733  
Fax: 2104-7633;  
International 852-2104-7633

**SINGAPORE**  
Lutron GL (Singapore)  
Tel: 65 220 4666  
Fax: 65 220 4333

#### **LIMITED WARRANTY**

Lutron Asuka Company, Ltd., will, at its option, repair or replace any unit that is defective in materials or manufacture within one year after purchase. For warranty service, return unit to place of purchase, or mail to Lutron Asuka Company, Ltd., at 2F, Kowa Shibakoen Building, 1-1-11, Shibakoen Minato-ku, Tokyo 105-0011 Japan, postage pre-paid, or telephone Lutron Asuka Company, Ltd., at 81-3-5405-7333.

This warranty is the sole express warranty, and the implied warranty of merchantability, as well as the implied warranty under the Japanese Civil Code (kashi-tampo), is limited to one year from purchase. This warranty does not cover the cost of installation, removal, or reinstallation, or damage resulting from misuse, abuse, or improper or incorrect repair, or damages from improper wiring or installation. This warranty does not cover incidental, consequential, or any special damages. Lutron Asuka Company's liability on any claim for damages arising out of or in connection with the manufacture, sale, installation, delivery, or use of the unit shall never exceed the purchase price of the unit.

This product may be covered by one or more of the following U.S. patents: 4,803,308; 4,835,343; 4,893,062; 4,924,151; 5,038,081; 5,309,068; 5,430,356; 5,463,286; 5,530,322; 5,633,540; 5,808,417; 5,949,200; 5,990,635; 6,046,550; 6,091,205; 6,188,181; D310,349; D311,170; D311,382; D311,485; D311,678; D313,738; D317,593; D335,867; D344,264; D370,663; D378,814; D412,315; D422,567; D436,930; and corresponding patents of other countries.

Lutron, GRAFIK Eye, GRAFIK 6000, Tu-Wire, and Hi-lume are registered trademarks; Eco-10, LIAISON, Designer, 2Link, RTISS, and Zone Capture are trademarks of Lutron Electronics Co., Inc. in the U.S.

Lutron, GRAFIK Eye, and Hi-lume are registered trademarks of Lutron Electronics Co., Inc. in Japan.

© 2001 Lutron Electronics Co., Inc.

**LUTRON**®

Lutron Electronics Co., Inc.  
Made and printed in U.S.A.  
P/N 032-103 Rev. A 1/02