

### Package Contents and Parts Identification

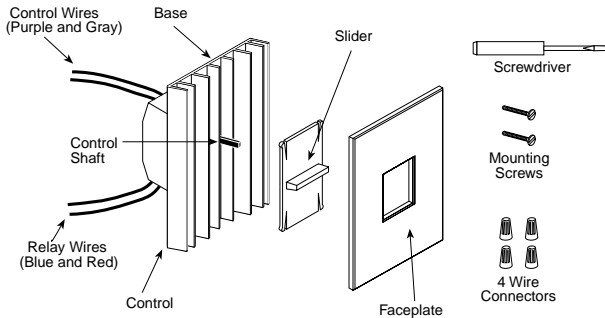

### Operation

The Low-Voltage Ballast Control (Class 2 wiring) provides dimming control for Lutron Eco-10 10 Volt Option Ballasts. The control allows dimming to 10% when used with these 10% dimming ballasts. Use this product only as intended with recommended accessories.

### Important Notes

#### Please Read Before Installation

**Wallbox Dimensions:** A single-gang wallbox (3" high x 2" wide x 2 1/2" deep) can be used for all individual controls.

**Wiring Note:** Always turn OFF AC power before installation. Install in accordance with all local and national electrical codes.

**Lamps:** For proper dimming performance new lamps must be operated at full intensity for 100 hours prior to dimming.

**Ballasts:** A single Low-Voltage Ballast Control can be used with a maximum of 60 Lutron Eco-10 10 Volt Option Ballasts.

**Do not** connect this control to line voltage.

**Switching:** If wiring for dimming with ON/OFF control, the Low-Voltage Ballast Control **must** be used with the Lutron PP-20 Power Pack.

**Compatible Ballasts:** Lutron Eco-10 10 Volt Option Ballasts have the following model number format: TVE-XXXX-XXX-X. For a complete list of ballast models refer to catalog sheet P/N 360-489.

This control **is not** compatible with Lutron Eco-10 Phase Control Option Ballasts. These ballasts have the following model number format: ECO-XXXX-XXX-X.

**Ballast Functionality Check:** With power OFF, check new ballast for functionality prior to installation of control by connecting the ballast's purple and gray wires together at the control. Turn power ON. The lights should now be at minimum brightness. With power OFF, disconnect the wires. Turn power ON. The lights should now be at maximum brightness.

### Pre-Installation

Determine whether this will be a single-gang installation or a multigang installation.

**If a single-gang installation:** Install unit as outlined in the "Installation" section below.

**If a multigang installation:** Before proceeding to the "Installation" section, follow the multigang installation procedure on pages 3-4 of this sheet and refer to the instruction sheet supplied with multigang faceplates.

### Installation

1. TURN POWER OFF to disable the 0-10 volt electronic ballast(s) to be dimmed.
2. Remove faceplate and slider from control to prevent surface damage and to access mounting holes. Pull on the faceplate at top and bottom edges to snap off the faceplate.
3. Strip wallbox wires to the following lengths:  
5/8" for No. 16, 18 and 20 gauge  
1/2" for No. 10, 12 and 14 gauge
4. Wire controls according to the appropriate wiring diagram shown in the "Wiring" section on pages 2-3 of this sheet and on the ballast.
5. Carefully push wires into wallbox allowing room for the control back cover.
6. Mount control to wallbox using screws provided. Units must be mounted vertically. See Figure A.

**Figure A: Front View - Mounting Control Unit**

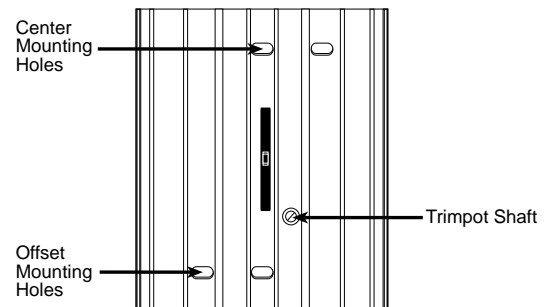

7. Turn power ON. Pushing slider up should increase light intensity. Pushing slider down should decrease light output to approximately 10% of the maximum light level for 10% dimming ballasts.
8. The maximum light level intensity may be adjusted as follows:
  - a. Push slider to the top-most position (maximum light intensity) and run lamps for 15 minutes to warm them.
  - b. Locate trimpot adjustment shaft (see Figure A on page 1).
  - c. Maximum light intensity is initially set at the factory to the maximum setting. Use the screwdriver provided to turn the trimpot screw (inside trimpot shaft) clockwise to decrease light level and counterclockwise to increase light level.
9. Snap faceplate onto dimmer by pressing firmly at the top, center, and bottom tabs. See Figure B.

**Figure B: Top View - Snap on Faceplate**

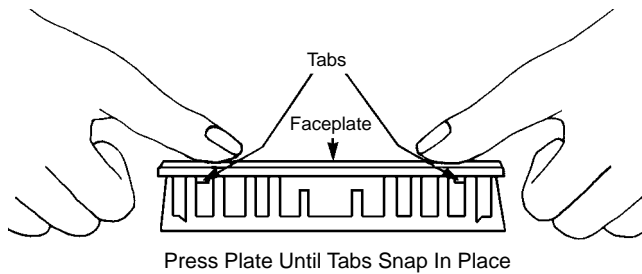

## Wiring

The total low-voltage wiring length for this unit should not exceed 500 ft. with No. 20 AWG. For long low-voltage wiring runs, or where excessive electrical noise exists, shielded cable or conduit is required. A maximum quantity of 60 electronic controllable ballasts can be connected to one control. Install in accordance with all local and national electrical codes.



**WARNING: LUTRON IS NOT LIABLE FOR DAMAGE DUE TO MISWIRING 0-10 VOLT CONTROL SIGNAL WIRES (CLASS 2) WITH LINE VOLTAGE.**

**DO NOT RUN CLASS 2 WIRES AND LINE VOLTAGE WIRING TOGETHER IN THE SAME CONDUIT.**

The Low-Voltage Ballast Control can be wired two ways: Dimming Only or Dimming with ON/OFF control. Use the appropriate wiring diagram.

## Dimming Only (No ON/OFF Control)

Connect the control as shown in Figure C. Changing slider position will alter light intensity from the ballast's maximum light intensity to minimum but not allow lights to be switched off.

**Figure C: Dimming Only Wiring**  
*Power wiring not shown—see ballast for wiring*

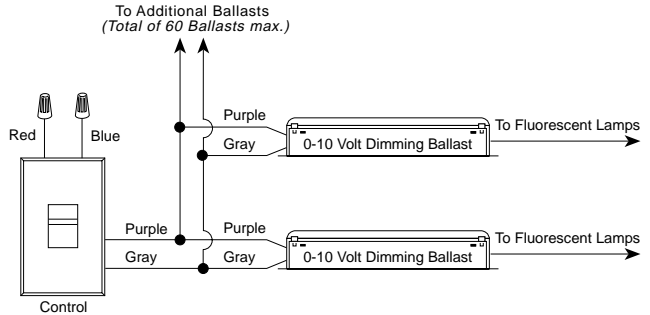

## Dimming Only Wallbox Wiring

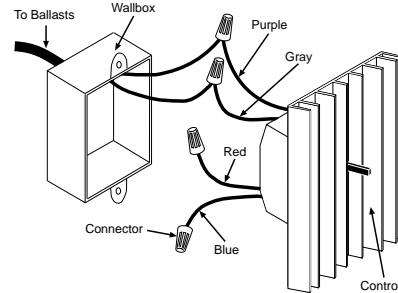

## Dimming With ON/OFF Control

Connect the control as shown in Figure D. Use only Lutron PP-20 Power Packs for AC line switching. Do not install the PP-20 Power Pack in the same wallbox as the Low-Voltage Ballast Control. Refer to the wiring sheet included with the PP-20 for more information.

**Figure D: Dimming With ON/OFF Control**  
**Wiring Diagram Using PP-20 Power Pack**

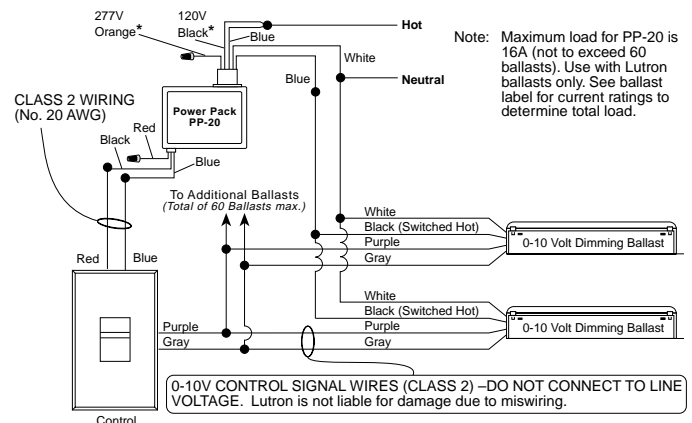

\*When wiring for 120 volt cap off orange wire. When wiring for 277 volt cap off black wire.

## Dimming With ON/OFF Control Wallbox Wiring

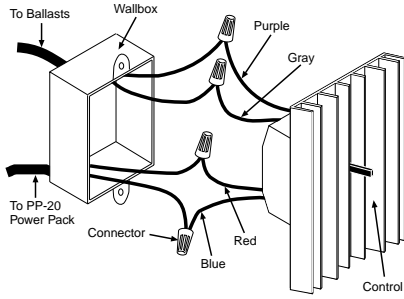

## Multigang Installation

In multigang installations several Low-Voltage Ballast Controls can be grouped horizontally in one ganging wallbox or in a series of connected wallboxes. Multigang faceplates are available to simplify and improve the appearance of this installation. A multigang mounting frame is provided with each standard multigang faceplate ensuring proper alignment of dimmers, easy application of faceplate, and a flat surface for installation. This frame is most easily mounted on the wall prior to connecting dimmer wires. Refer to the instruction sheet supplied with the multigang faceplate when using these components. For retrofit installations, the side sections can be removed to fit existing wallboxes (refer to the section "Multigang Installation – Side Sections Removed" on pages 3-4).

### No Side Sections Removed

1. Determine the number of wallboxes necessary by using the Wallbox Requirement Chart (Table A).

**Table A: Wallbox Requirement Chart**  
No Side Sections Removed

	Number of Controls					
	1	2	3	4	5	6
Wallboxes	1	1+1*	4	4+1*	7	7+1*

\* See Item 2

2. When ganging, use 3" x 2" gangable wallboxes. **Do not use plaster rings or gangbox covers.** For an EVEN number of controls, one control will be  $\frac{3}{4}$ " apart from the other wallbox(es) to provide necessary space for the faceplate(s). For example, when ganging four controls, three would be in the four connected wallboxes and one would be in a wallbox separated by  $\frac{3}{4}$ ". See Figure E.

**Figure E: Wallbox Positioning Four-Ganged Controls**

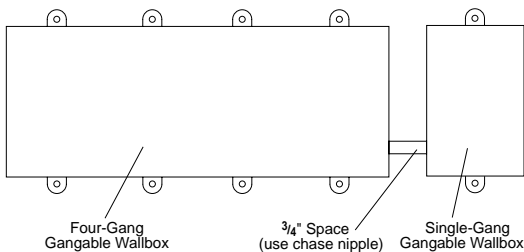

3. When mounting controls in wallboxes, use center mounting holes as required for first unit, then use offset mounting holes as required for proper alignment. See Figure F. Allow  $\frac{1}{32}$ " between controls for ease in attaching faceplates.

**Figure F: Front View - Four-Ganged Installation**  
No Side Sections Removed

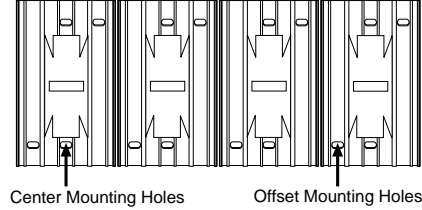

4. Snap on multigang faceplate (or multiple single faceplates) and adjust up or down for a snug fit. Multigang faceplates include mounting frames and instructions. See Figure G.

**Figure G: Multiganged Unit With Faceplate**  
No Side Sections Removed

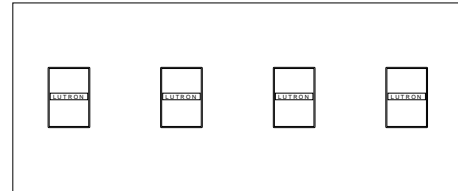

*Multigang faceplates, which eliminate the need to cut individual faceplates, are available in a variety of colors to beautify and simplify your installation.*

### Side Sections Removed

1. One gangable wallbox is needed for each control in the multiganged unit. Individually connect wallboxes or use a pre-assembled multigang wallbox.
2. Remove INNER side sections only. Using pliers, bend side sections down as far as you can and then back to their original positions. Side sections will break off. See Figure H.

**NOTE: DO NOT REMOVE OUTER SIDE SECTIONS OF THE TWO DIMMERS WHICH ARE ON THE ENDS OF THE GANG.**

**Figure H: Side Section Removal**

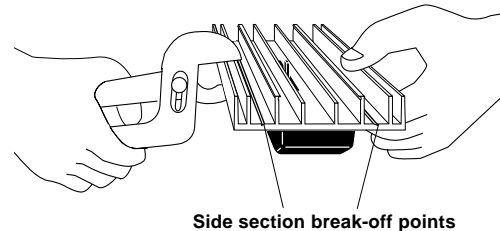

- When mounting, use center mounting holes as required for proper alignment. See Figure I.

**Figure I: Front View – Four-Ganged Installation  
Side Sections Removed**

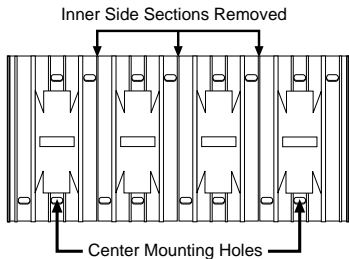

- Snap on multigang faceplate (or multiple single faceplates- see "Cutting Faceplates When Removing Side Sections" below) and adjust up or down for a snug fit. Multigang faceplates include mounting frames and instructions. See Figure J.

**Figure J: Multiganged Unit With Faceplate  
Side Sections Removed**

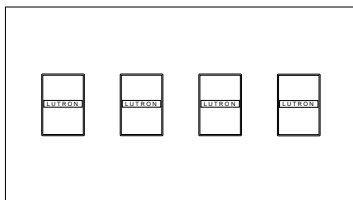

*Multigang faceplates, which eliminate the need to cut individual faceplates, are available in a variety of colors to beautify and simplify your installation.*

### Cutting Single Faceplates When Side Sections Are Removed

Single faceplates will need to be cut if side sections are removed and a multigang faceplate is *not* used. Before cutting the faceplate, place it on a soft cloth face down. Then pressing firmly, score the vertical groove on the back of the faceplate with a razor sharp knife — use the groove to keep knife on a straight course as shown. Bend the scored section back and forth to break it off. Smooth cut edge by placing fine-grained sandpaper on a flat surface and rubbing the edge over the sandpaper a few times. Hold faceplate steady as you rub to keep a true edge.

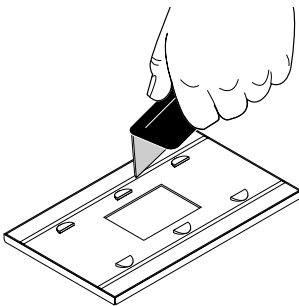

## Troubleshooting

### LIGHTS DO NOT OPERATE AT FULL BRIGHTNESS:

- Push slider up. Turn trimpot counterclockwise with the screwdriver provided to achieve maximum light intensity.
- Check to see that purple and gray wires are not cross connected in any fixture, conduit, or wallbox.

### LIGHTS DO NOT DIM LOW ENOUGH:

- A dimming range of 100% to 10% should be achieved for 10% dimming ballasts by moving the slider. Check the ballast output with a light meter in the absence of other sources of illumination (or correct for other sources) at both high and low light readings. The ratio of the low reading and the high reading should be 1:10 or 0.1.

When taking the high end measurement, the slider should be at the top-most position and trimpot adjusted to provide maximum light output. When taking the low end measurement, the slider should be at the bottom most position. Allow lamps to stabilize for a minimum of 10 minutes before taking readings.

- If the 100% to 10% dimming range is not achieved, check to see that purple and gray wires are not cross connected in any fixtures.

## Worldwide Technical and Sales Assistance

If you have questions concerning the installation or operation of this product, call the **Lutron Technical Assistance Hotline**. Please provide exact model number when calling.

(800) 523-9466 (U.S.A., Canada, and the Caribbean)

Other countries call (610) 282-3800

Fax (610) 282-3090

## Warranty

Lutron will, at its option, repair or replace any unit that is defective in materials or manufacture within one year after purchase. For warranty service, return unit to place of purchase or mail to LUTRON at 7200 Suter Road, Coopersburg, PA 18036-1299, postage prepaid.

**This warranty is in lieu of all other warranties, express or implied, and the implied warranty of merchantability is limited to one year from purchase. This warranty does not cover the cost of installation, removal, or reinstallation, or damage resulting from misuse, abuse, or damage resulting from improper wiring or installation.**

This warranty gives you specific legal rights, and you may also have other rights which vary from state to state. Some states do not allow the exclusion or limitation of incidental or consequential damages or limitations on how long an implied warranty may last, so the above limitations may not apply to you.

# LUTRON®

Lutron Electronics Co., Inc.  
7200 Suter Road  
Coopersburg, PA 18036-1299 U.S.A.  
Made and printed in U.S.A. 3/98 P/N 037-084 Rev. C