

### Installation Instructions

*Please Read Before Installing*

HWS-3B-G, HWS-3B-B, HWS-4B-G, HWS-4B-B  
15V  $\overline{=}$ , 65 mA Class 2/PELV

### Overview

The HWS-3B and HWS-4B are for use with *HomeWorks* systems. The keypad buttons are programmed using the *HomeWorks* Utility.

Up to 32 keypads, each with a unique address, can be connected to each keypad link on the *HomeWorks* processor. A maximum of 300 keypad LEDs can be connected per processor. Each HWS-3B keypad counts as 6 LEDs, and each HWS-4B keypad counts as 8 LEDs. To add capacity beyond 300 LEDs, refer to the section about the HWI-PS in the *HomeWorks* Technical Reference Guide (P/N 366-963).

**HWS-3B-G**  
**HWS-3B-B**

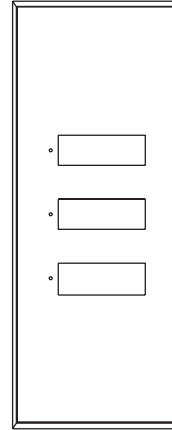

### Important Notes

**Codes:** Install in accordance with all local and national electrical codes.

**Environment:** Ambient operating temperature: 0-40°C, 32-104°F, 0-90% humidity, non-condensing.  
*Indoor use only.*

**Cleaning:** To clean, wipe with a clean damp cloth.  
**DO NOT** use any chemical cleaning solutions.

**Wallboxes:** *Signature Series* keypads may be mounted in a door jamb without a wallbox, or mounted in a wall using a special wallbox (Lutron Model # WBOX-SA1-Q1, purchased separately). See Mounting Diagram (page 2).

**Keypad Wiring:** Keypad wiring may be in a daisy-chain, star or T-tap configuration. Each home run on a link may be up to 1,000 ft. (305 m) and may contain up to 10 keypad devices. The total length of wire on that link (all home runs) may be up to 4,000 ft. (1220 m). Up to 32 keypad devices may be placed on each processor link configured as a keypad link in the *HomeWorks* Utility. An external power supply may be required depending on the total current draw of all keypad devices on the processor.

**HWS-4B-G**  
**HWS-4B-B**

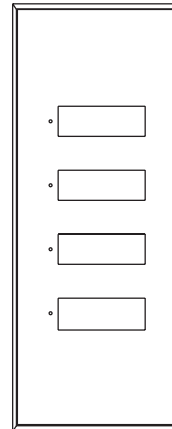

## Installation

1. Disconnect power to the keypads by turning off all circuit breakers connected to the HomeWorks® Processor or keypad link auxiliary power supply (HWI-PS).



**Wiring with power ON may result in personal injury.**

2. Address keypads. Assign a unique address to each keypad using the DIP switch on the back of the keypad. See Keypad Addressing (page 3) for DIP switch location and DIP switch settings. Be sure to record the address for future programming purposes.
3. Strip insulation from wires to 3/8 in. (10mm). Each terminal will accept one or two #18 AWG (1.0 mm<sup>2</sup>) wires.
4. Unplug keypad link terminal block from the keypad circuit board.
5. Connect wiring to terminal block as shown in Wiring Diagram (page 3).
6. Plug the keypad link terminal block back onto the circuit board. Be sure to orient the terminal block correctly.
7. Mount keypad as shown in Mounting Diagram. **Do not over-tighten mounting screws.**
8. Restore power to the HomeWorks Processor or keypad link auxiliary power supply.

## Mounting Diagram

### With wallbox

Mounting Hole 2-7/8 in. (73mm) deep minimum

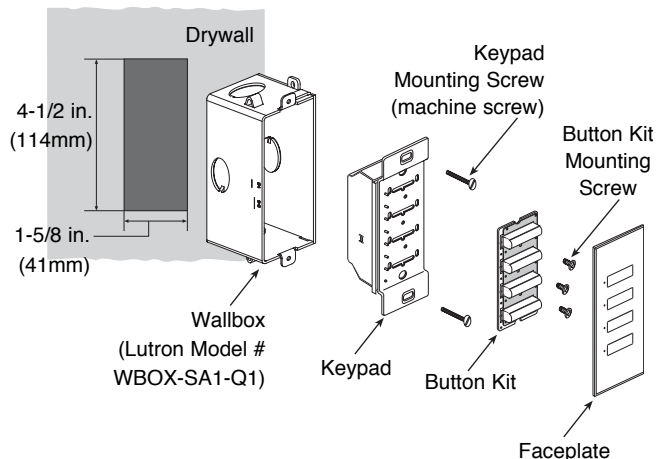

### Without wallbox

Mounting Hole 2-7/8 in. (73mm) deep minimum

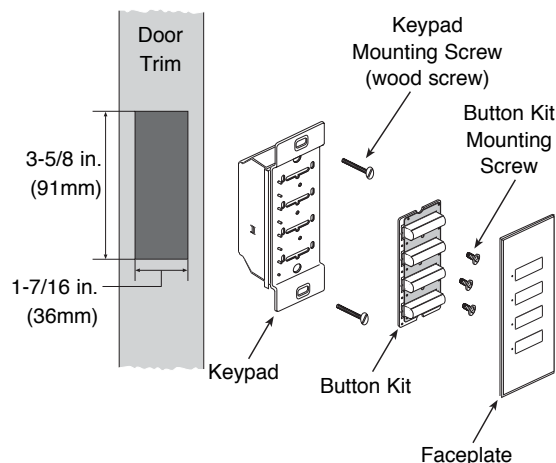

# Keypad Addressing

## Keypad Rear View

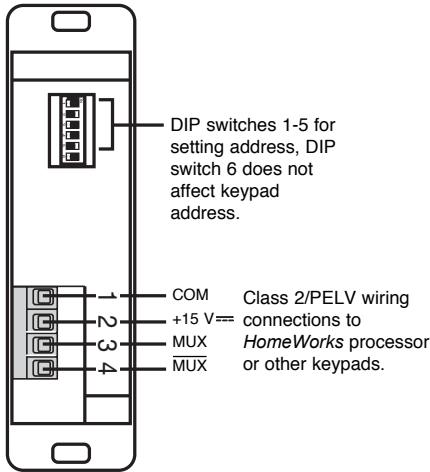

## DIP Switches

Set DIP switches 1-5 to give the keypad a unique HomeWorks® system address from 1 to 32.

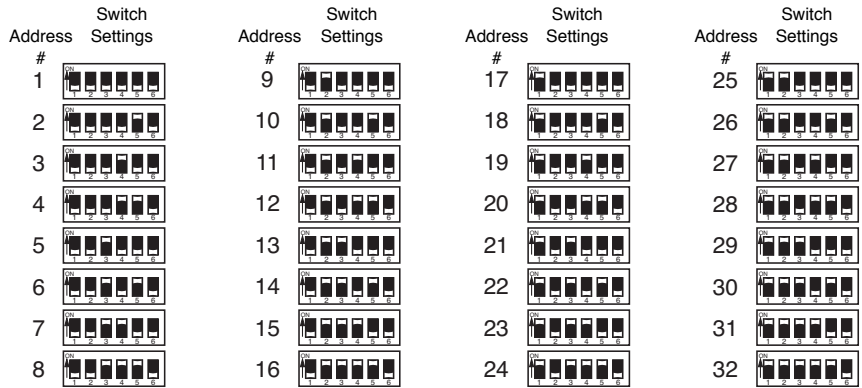

Example: Setting Switch #1 ON.

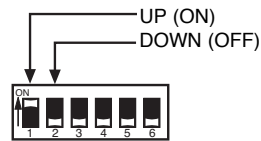

## Wiring Diagram

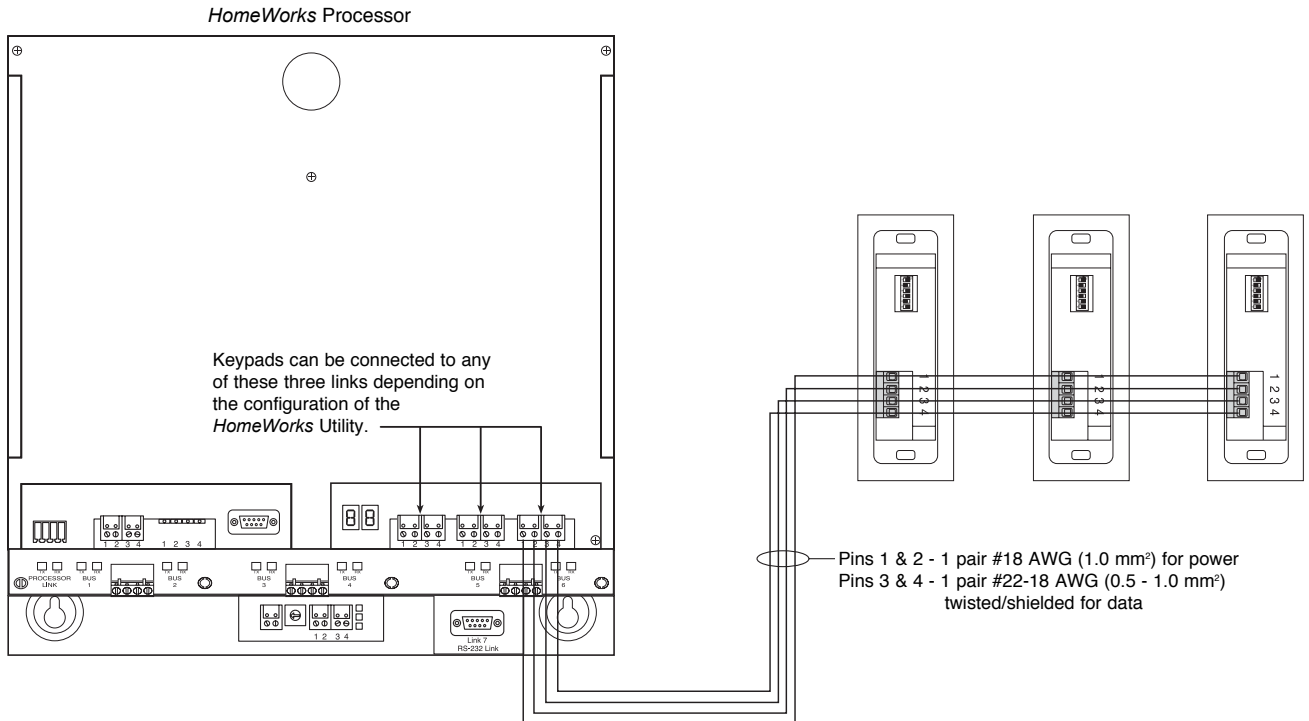

# Troubleshooting Guide

Keypad is working properly when LEDs light up and loads respond as buttons are pressed.

Symptom	Cause and Action
LEDs don't light up.	<p>Power is not present at keypad.</p> <ul style="list-style-type: none"> <li>• Make sure HomeWorks® Processor is powered up.</li> <li>• Check for 15 V<sub>DC</sub> between pins 1 &amp; 2 on the keypad connector.</li> <li>• Remove connector from back of keypad, check connections and replace.</li> </ul>
LEDs cycle from top to bottom sequentially.	<p>Keypad is properly powered but is not communicating with the processor.</p> <ul style="list-style-type: none"> <li>• Verify that the processor is running.</li> <li>• Check that keypad wires 3 &amp; 4 are properly connected.</li> <li>• Check that keypad link is plugged into correct connector at processor.</li> <li>• Verify that link is configured for <i>HomeWorks</i> keypads in the <i>HomeWorks</i> Utility.</li> </ul>
LEDs light when button is pressed, but the system response isn't correct.	<p>Keypad improperly addressed.</p> <ul style="list-style-type: none"> <li>• Check keypad for proper address. See Keypad Addressing (page 3).</li> </ul> <p>Keypad improperly programmed.</p> <ul style="list-style-type: none"> <li>• Check system programming.</li> </ul>

## Technical and Sales Assistance

If you need assistance, call the toll-free **Lutron Technical Support Center**. Please provide exact model number when calling.

(800) 523-9466 (U.S.A., Canada and the Caribbean)

Other countries call:

Tel: (610) 282-3800

Fax: (610) 282-3090

Visit our Web site at [www.lutron.com](http://www.lutron.com)

## LIMITED WARRANTY

Lutron will, at its option, repair or replace any unit that is defective in materials or manufacture within two years after purchase. For warranty service, return unit to place of purchase or mail to Lutron at 7200 Suter Rd., Coopersburg, PA 18036-1299, postage pre-paid. Telephone the Lutron Technical Support Center toll free at 800-523-9466. After the two year period, a pro-rated warranty applies to this product until eight years after the purchase. For more information regarding this warranty contact your Lutron representative.

**THIS WARRANTY IS IN LIEU OF ALL OTHER EXPRESS WARRANTIES, AND THE IMPLIED WARRANTY OF MERCHANTABILITY IS LIMITED TO TWO YEARS FROM PURCHASE. THIS WARRANTY DOES NOT COVER THE COST OF INSTALLATION, REMOVAL OR REINSTALLATION, OR DAMAGE RESULTING FROM MISUSE, ABUSE, OR IMPROPER OR INCORRECT REPAIR, OR DAMAGE FROM IMPROPER WIRING OR INSTALLATION. THIS WARRANTY DOES NOT COVER INCIDENTAL OR CONSEQUENTIAL DAMAGES. LUTRON'S LIABILITY ON ANY CLAIM FOR DAMAGES ARISING OUT OF OR IN CONNECTION WITH THE MANUFACTURE, SALE, INSTALLATION, DELIVERY, OR USE OF THE UNIT SHALL NEVER EXCEED THE PURCHASE PRICE OF THE UNIT.**

This warranty gives you specific legal rights, and you may also have other rights which vary from state to state. Some states do not allow limitations on how long an implied warranty lasts, so the above limitation may not apply to you. Some states do not allow the exclusion or limitation of incidental or consequential damages, so the above limitation or exclusion may not apply to you.

This product may be covered by one or more of the following U.S. patents: 4,889,999; 5,170,068; 5,237,207 and corresponding foreign patents. U.S. and foreign patents pending. Lutron and HomeWorks are registered trademarks and Signature Series is a trademark of Lutron Electronics Co., Inc.

© 2003 Lutron Electronics Co., Inc.