

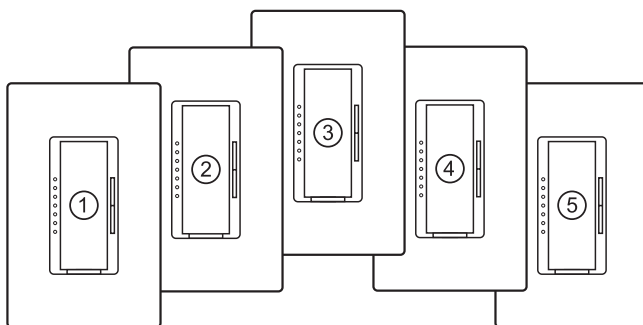

## Homeowner's Guide

### RadioRA® Dimmers

- Turn lights in a room on and off
- Dim lights in each room or area
- Preset light level for each room



### RadioRA® 10-Button Tabletop Master Control

- Turns all lights on and off
- Controls groups of lights pre-set as a lighting scene
- Monitors on or off status of lights
- Adapter power for real time light status monitoring, or battery power for portability

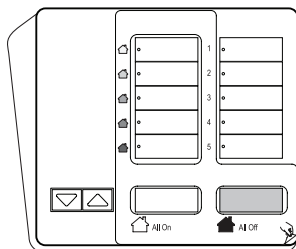

### RadioRA® RF Signal Repeater

- Ensures reliable system communications and function
- Allows for future system expansion

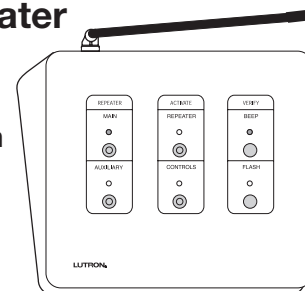

### RadioRA® Visor Control Transmitters

- Turns lights on to preset levels and off from the car
- Operates garage doors from the car
- HomeLink® compatible

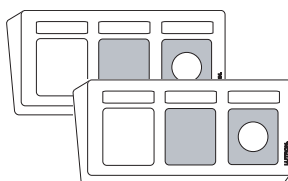

### RadioRA® Multi-Function Entry Master Control

- Enables use of Visor Control Transmitters
- Functions as an additional Master Control
- Operates garage doors

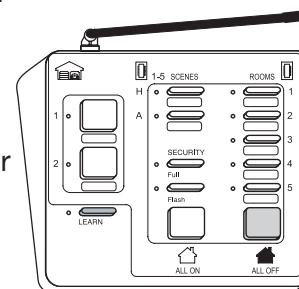

# RadioRA® Quick Start Wireless Home Lighting Control System

### Package Contents:

- |                                       |   |
|---------------------------------------|---|
| (5) 600 W Dimmers                     | (1) Multi-Function Entry Master Control |
| (2) 3-Way Accessory Dimmers           | (2) Car Visor Control Transmitters      |
| (1) 10-Button Tabletop Master Control | (1) RF Signal Repeater                  |

*These instructions are for RALB-QS-CAR and RBLB-QS-CAR.*

## Device Locations

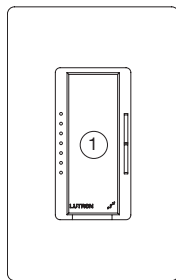

Dimmer 1

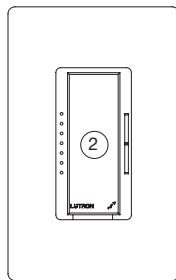

Dimmer 2

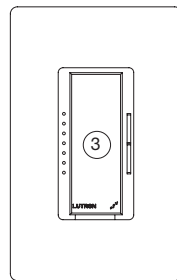

Dimmer 3

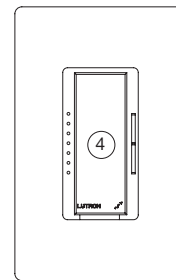

Dimmer 4

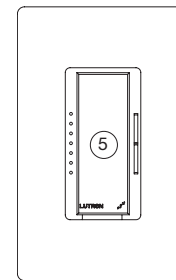

Dimmer 5

Location: \_\_\_\_\_

\_\_\_\_\_

\_\_\_\_\_

\_\_\_\_\_

\_\_\_\_\_

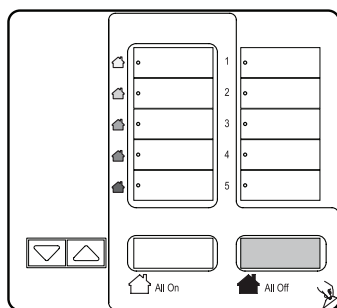

10T  
10-button Tabletop  
Master Control

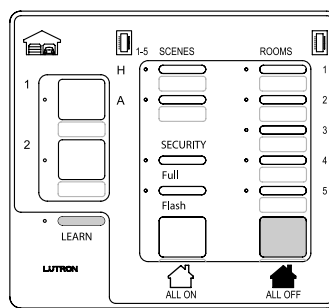

MFE  
Multi-Function Entry  
Master Control

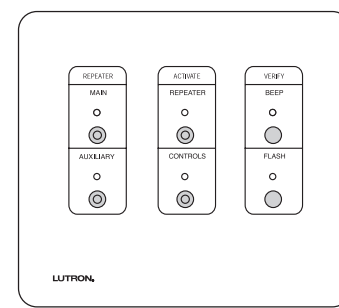

RF Signal Repeater

Location: \_\_\_\_\_

\_\_\_\_\_

\_\_\_\_\_

## Dimmers

Replace conventional light switches. Lights can be turned on at the RadioRA® Dimmers or remotely by the Master Control.

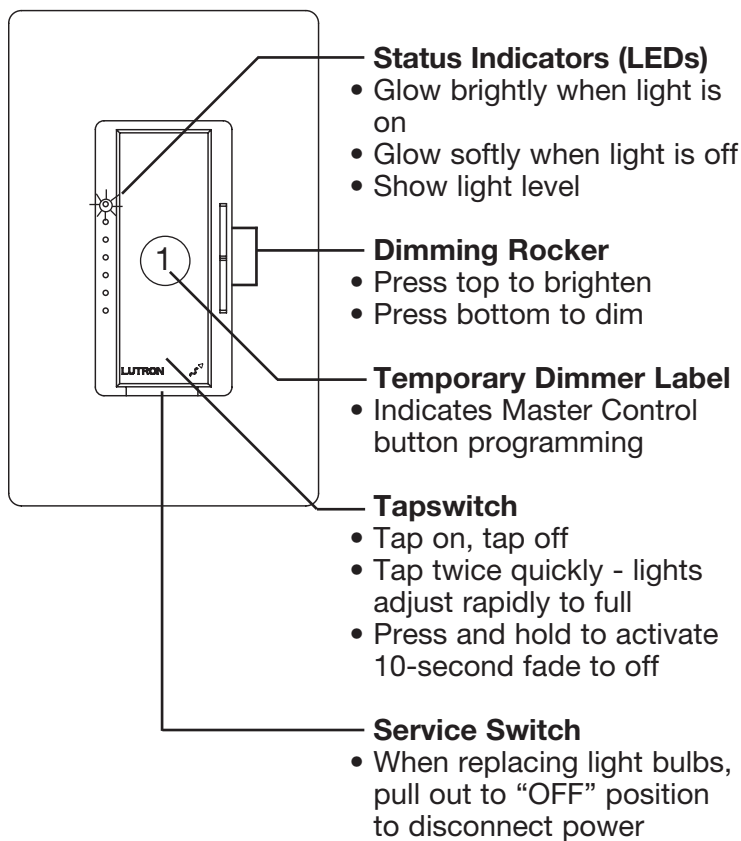

## Benefits of Dimming



Reduce energy consumption.



Extend bulb life and decrease the amount of times you change your light bulbs.

## Lutron Energy Saving Chart for Incandescent Light Bulbs \*

Light Level	Electricity Saved	Lamp Life Extended
90%	10%	2 Times
75%	20%	4 Times
50%	40%	20 Times
25%	60%	Greater than 20 Times

\* Numbers are approximate

## Accessory Dimmers

Two Accessory Dimmers are included in this package to allow for 1 or 2 multi-location installations. Some homes do not have multi-location installations. In these cases, the Accessory Dimmers will not be used.

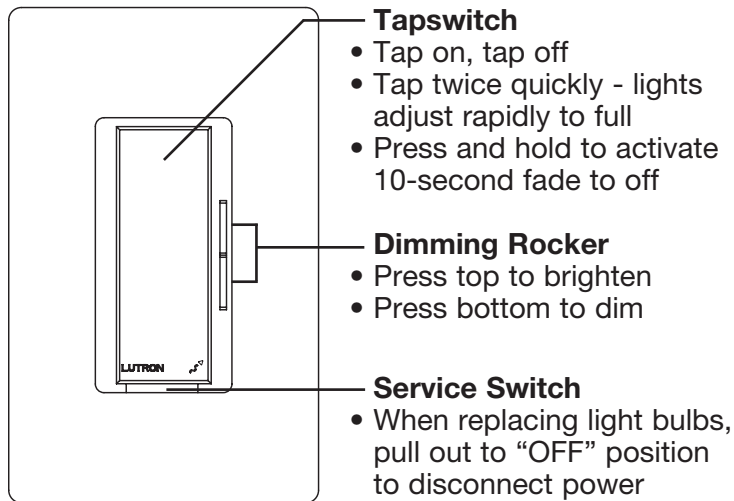

Single location installation

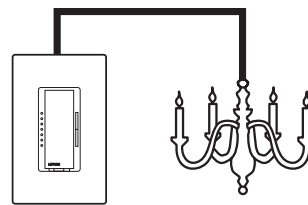

Multi-location installation

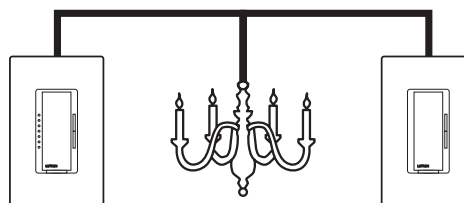

## 10-Button Tabletop Master Control (10T)

Controls RadioRA® Dimmers remotely.

- |  |   |
|--|---|
| <p><b>SCENE Buttons</b><br/>Turn on and off preset lighting scenes</p> | <p><b>ROOM Buttons</b><br/>Monitor and turn individual room lights on and off</p> |
|--|---|

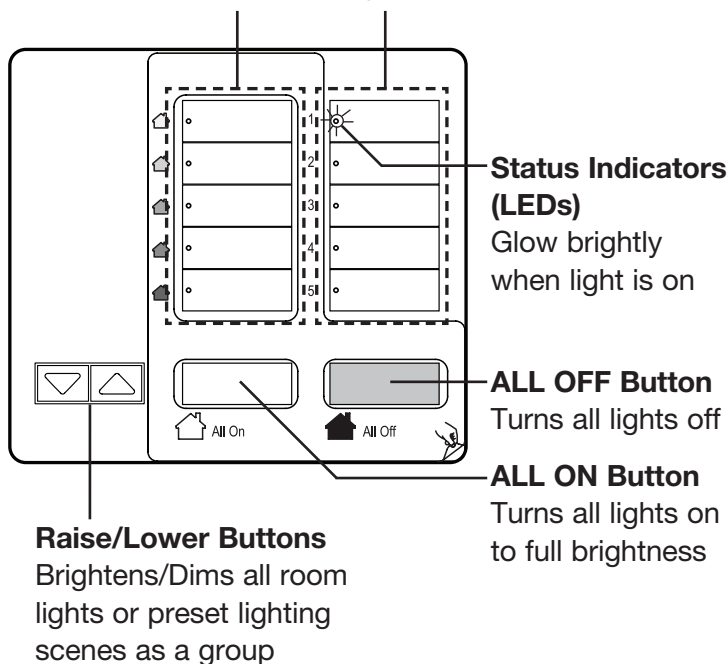

 Master Control(s) may be moved to another location. All *RadioRA* devices retain their programming for over 10 years, even when they are unplugged.

## Using Raise/Lower Buttons on the 10T Master Control

Raise/Lower buttons will affect the last Room/Scene button pressed on the Master Control.

**Note:** Left column Scene buttons—LED will go out once the scene is dimmed up or down.  
Right column Room buttons—LED will turn on or stay on once the room is dimmed up or down.

## Multi-Function Entry Master Control (MFE)

Controls RadioRA® Dimmers remotely.

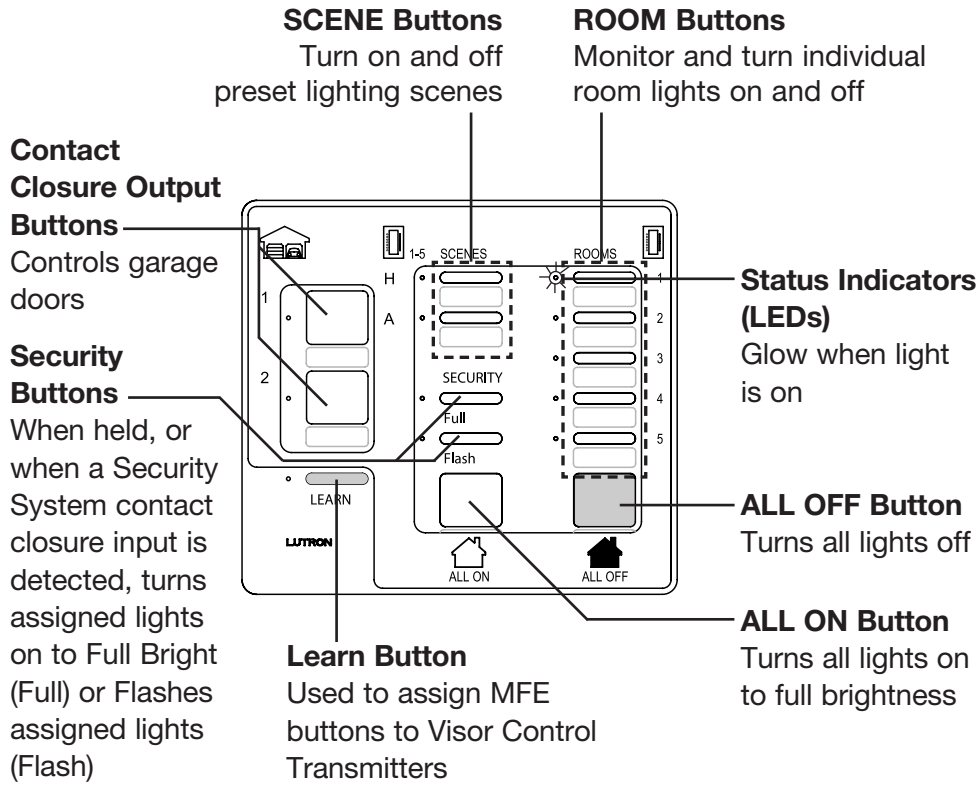

## Visor Control Transmitters

Provide control of lights and garage doors from the convenience of the car.

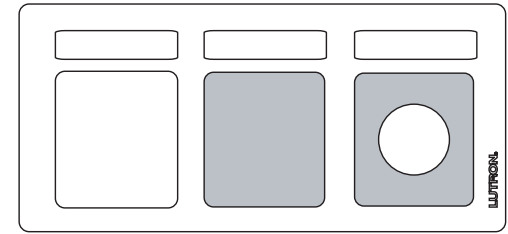

**Buttons**  
Remotely activate buttons on the Multi-Function Entry Master Control

## RF Signal Repeater

Provides alternate RF signal communication path and RF diagnostics.

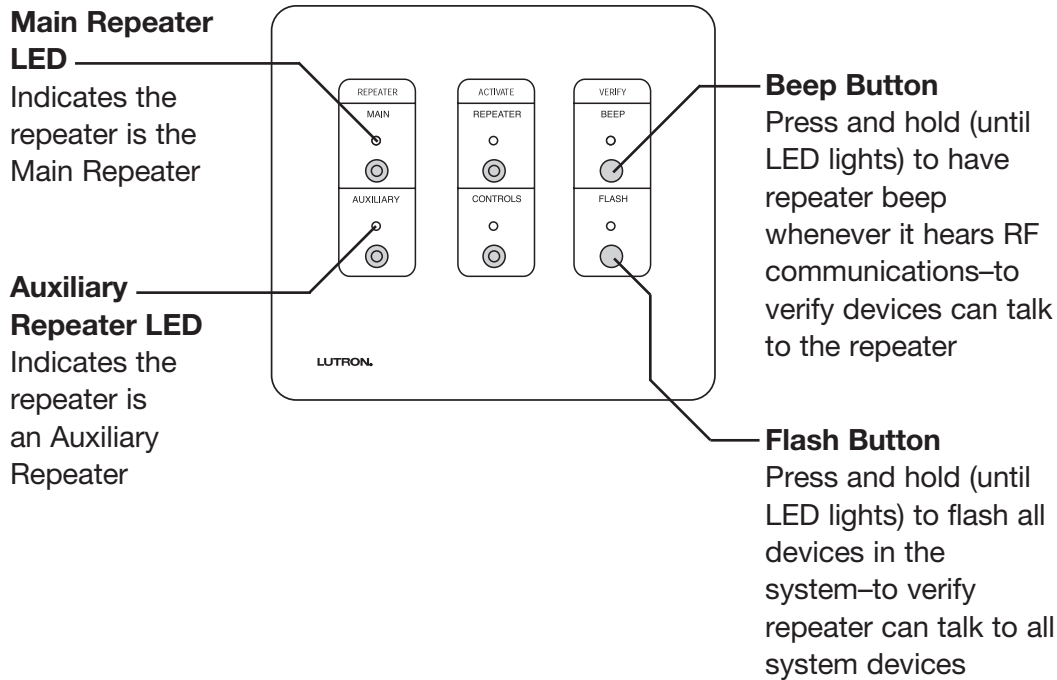

## Customizing Master Control Buttons

### Modifying Preset Light Levels For Master Control Buttons

Level Capture allows you to easily change the preset levels associated with Master Control buttons. By simply pressing and holding a Master Control button, new light levels can be assigned in the same way that a radio station is assigned to a radio button in a car. It does not allow you to add a light to a button or remove lights from a button—that must be done in programming mode (refer to *RadioRA Setup Guide P/N 044-001* that came with your RF Signal Repeater for more information).

#### How do I use Level Capture?

1. Choose a button to reprogram. Press that button to turn the lights off and back on so that you are familiar with exactly which lights it controls.

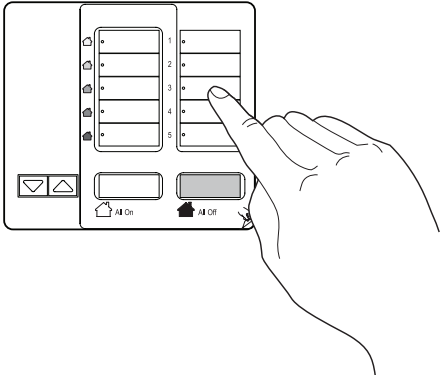

2. After turning the lights on from the chosen button, go to each Dimmer and adjust the light intensity to the desired level.

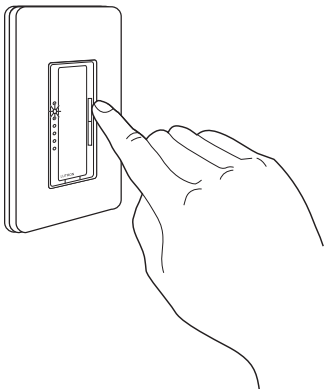

3. Return to the Master Control and press and hold the chosen button until the LED next to the button flashes, turns on, blinks twice, then remains on (this will take 5-8 seconds).

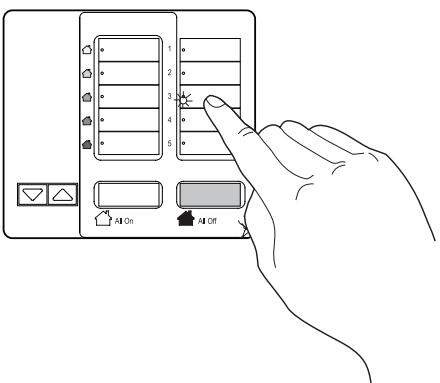

**Note: Scene buttons** - In step 2, if you set a particular light to OFF and then perform step 3, that light will now turn off whenever the chosen scene button is pressed.  
**Room buttons** - In step 2, if you set a particular light to OFF and then perform step 3, that light will retain its previous light level settings.

## Button Assignments

### 10T Master Control SCENES

Your SCENE Name	Button Number
_____	6
_____	7
_____	8
_____	9
_____	10

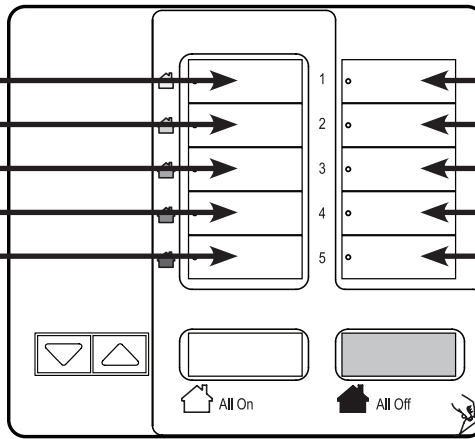

### 10T Master Control ROOMS

Your ROOM Name
_____
_____
_____
_____
_____

- Dimmer ①
- Dimmer ②
- Dimmer ③
- Dimmer ④
- Dimmer ⑤

### Entry Master Control SCENES

Your SCENE Name	Button Number
_____	6
_____	7

Your Garage Door Name	Door Button Number
_____	1
_____	2

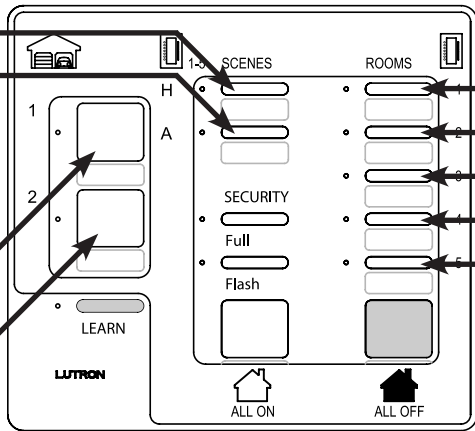

### Entry Master Control ROOMS

Your ROOM Name
_____
_____
_____
_____
_____

- Dimmer ①
- Dimmer ②
- Dimmer ③
- Dimmer ④
- Dimmer ⑤

### Visor Control Transmitter 1

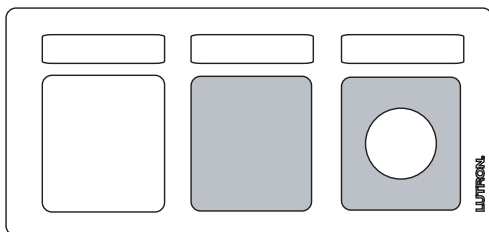

VCTX Button	Controls Entry Master Control Button
White	_____
Gray	_____
Gray with white circle	_____

### Visor Control Transmitter 2

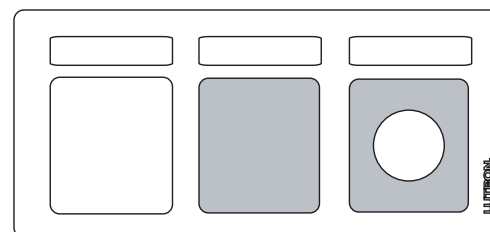

VCTX Button	Controls Entry Master Control Button
White	_____
Gray	_____
Gray with white circle	_____

## Labels

When you are comfortable with using your system, remove the temporary instructional labels from the Dimmers and Master Controls.

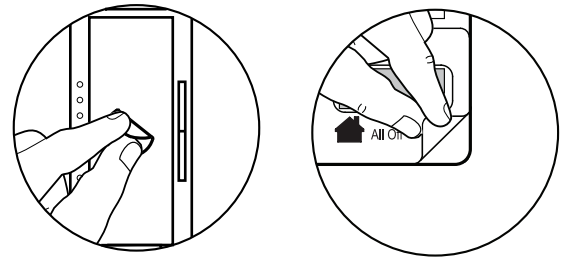

Using the charts filled out on the previous page as a reference, apply labels supplied with controls to each button on the 10T Master Control, to the pockets below the buttons on the Entry Master Control and to the pockets above the buttons on the Visor Control Transmitter:

1. Be sure to have clean hands—any dirt on fingers can get under the labels permanently.
2. Use a pocket knife or other small thin instrument to help place the labels cleanly.
3. Use a cotton swab to firmly press label in place.

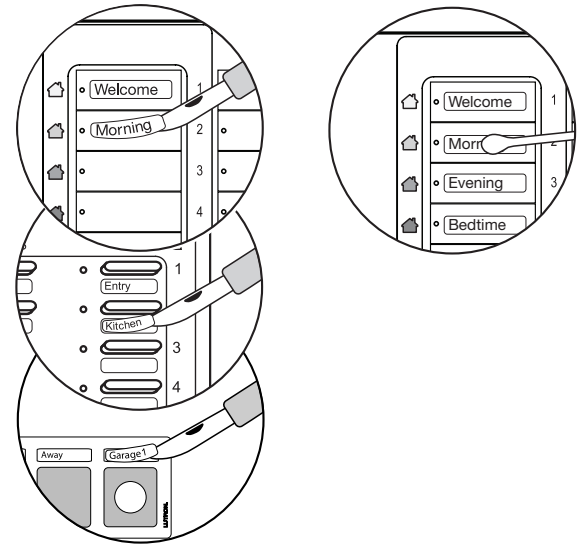

## Complete Labeling

1. Apply ROOM and SCENE labels at the top of each Entry Master Control column as shown.
2. Apply DOORS label above the left-most column of the Entry Master Control as shown.
3. Apply ALL ON and ALL OFF labels below the ALL ON and ALL OFF buttons as shown.

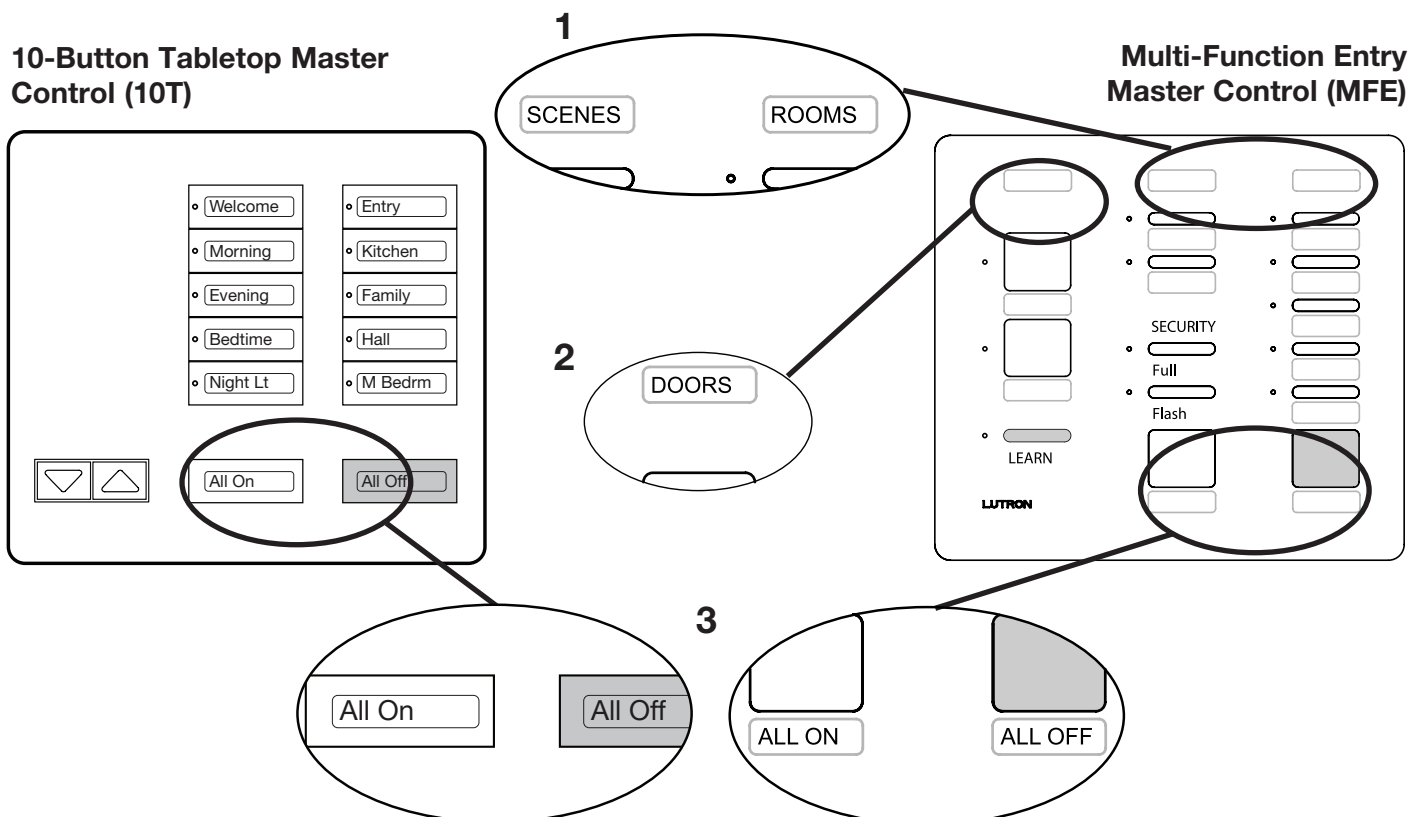



# Fill Out Engraving Schedule for 10T Master Control

When final engraving is determined fill out Engraving Schedule(s) at [www.lutron.com/buttons](http://www.lutron.com/buttons).

## Redeem Prepaid Engraving Certificate

Choose one of the following options to redeem the Prepaid Engraving Certificate(s) for your personalized engraved buttons.

 **E-mail** Engraving Schedule pdf(s) with Engraving Certificate Number(s) filled in to: [engraving@lutron.com](mailto:engraving@lutron.com)

 **Fax** Engraving Schedule(s) with Engraving Certificate Number(s) filled in to: 610.282.3090

 **Mail** Engraving Schedule(s) and Engraving Certificate(s) to:  
Lutron Electronics Co., Inc.  
Dept. 309, Engraving  
7200 Suter Road  
Coopersburg, PA 18036



Engraving Certificate Number

## How RadioRA Communication Works

**1.** Master Control transmits message: "Dimmer turn lights ON".

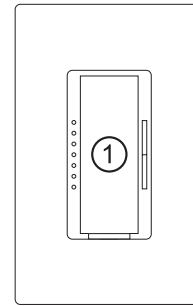
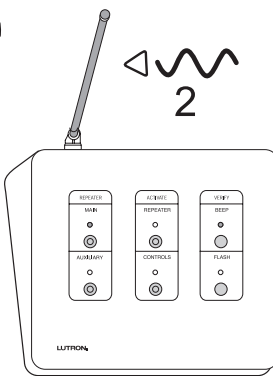
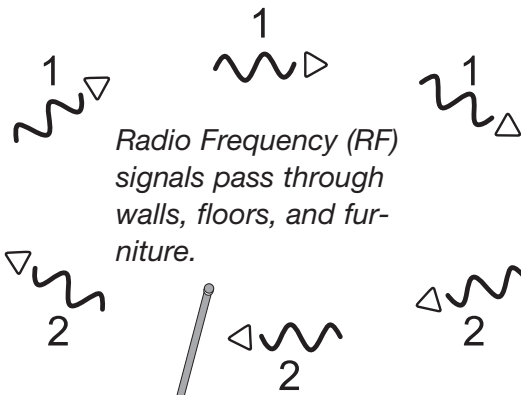
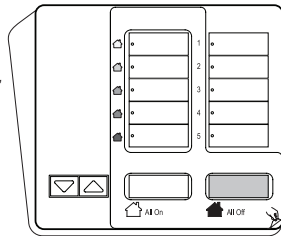

**2.** Dimmer turns on lights and transmits message back to Master Control: "lights are ON".

**3.** Glowing LED on Master Control indicates "lights are ON".

### RF Signal Repeater

Ensures that all RF signals go to Dimmers and back to Master Control by enhancing signals and providing an alternate route.

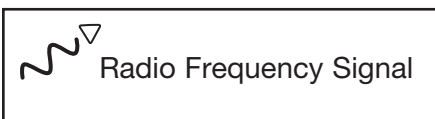

## Worldwide Technical and Sales Assistance

If you have questions concerning the installation or operation of this product, call the **Lutron Technical Support Center**. Please provide exact model number when calling. +1.800.523.9466 (U.S.A., Canada, and the Caribbean) Other countries call +1.610.282.3800 Fax +1.610.282.3090 Visit us on the Web at [www.lutron.com/radiora](http://www.lutron.com/radiora)

For Warranty information, please see the warranty that was enclosed with the product, or visit: [www.lutron.com/resiinfo](http://www.lutron.com/resiinfo).

This product may be covered under one or more of the following U.S. patents: 5,248,919; 5,399,940; 5,637,930; 5,798,581; 5,838,226; 5,848,054; 5,905,442; 5,982,103; 6,169,377; 6,687,487; 7,071,634; 7,166,970; D353,798; D389,805; D404,013; and D461,782 and corresponding foreign patents. U.S. and foreign patents pending. NEC is a registered trademark of the National Fire Protection Association, Quincy, Massachusetts. HomeLink is a registered trademark of Johnson Controls, Inc., Milwaukee, Wisconsin. Lutron, RadioRA and the Sunburst logo are registered trademarks of Lutron Electronics Co., Inc. © 2007 Lutron Electronics Co., Inc.

Lutron Electronics Co., Inc.  
7200 Suter Road  
Coopersburg, PA 18036  
Made and printed in the U.S.A. P/N 044-131 6/07 Rev. A

