

Limited Warranty

Lutron will, at its option, repair or replace any unit that is defective in materials or manufacture within one year after purchase. For warranty service, return unit to place of purchase or mail to Lutron Electronics Co., Inc. at 7200 Suter Rd., Coopersburg, PA 18036-1299, postage pre-paid.

THIS WARRANTY IS IN LIEU OF ALL OTHER EXPRESS WARRANTIES, AND THE IMPLIED WARRANTY OF MERCHANTABILITY IS LIMITED TO ONE YEAR FROM PURCHASE. THIS WARRANTY DOES NOT COVER THE COST OF INSTALLATION, REMOVAL OR REINSTALLATION, OR DAMAGE RESULTING FROM MISUSE, ABUSE, OR DAMAGE FROM IMPROPER WIRING OR INSTALLATION. THIS WARRANTY DOES NOT COVER INCIDENTAL OR CONSEQUENTIAL DAMAGES. LUTRON'S LIABILITY ON ANY CLAIM FOR DAMAGES ARISING OUT OF OR IN CONNECTION WITH THE MANUFACTURE, SALE, INSTALLATION, DELIVERY, OR USE OF THE UNIT SHALL NEVER EXCEED THE PURCHASE PRICE OF THE UNIT.

This warranty gives you specific legal rights, and you may have other rights which vary from state to state. Some states do not allow the exclusion or limitation of incidental or consequential damages, or limitation on how long an implied warranty may last, so the above limitations may not apply to you.

This product may be covered under one or more of the following U.S. patents: 4,835,343; 4,954,768; 5,248,919; 5,399,940; 5,637,930; 5,736,965; 5,798,581; 5,838,226; 5,848,054; 5,905,442; 5,982,103; DES 353,798; DES 378,814; DES 389,461; DES 389,805; DES 395,037; DES 404,013; DES 422,969; DES 428,855; DES 436,579; DES 439,220 and corresponding foreign patents. U.S. and foreign patents pending. Lutron, RadioRA, and GRAFIK Eye are registered trademarks, and FASS is a trademark of Lutron Electronics Co., Inc.
© 2001 Lutron Electronics Co., Inc.

Technical Assistance

If you have questions concerning the installation or operation of this product, call the **Lutron Technical Support Center**. Please provide exact model number when calling.

(800) 523-9466 (U.S.A., Canada, and the Caribbean)

Other countries call (610) 282-3800

Fax (610) 282-3090

Visit our web site at www.lutron.com

World Headquarters

Lutron Electronics Co., Inc.

7200 Suter Road

Coopersburg, PA 18036-1299 U.S.A.

TOLL FREE: (800) 523-9466 (U.S.A., Canada, and the Caribbean)

Tel: (610) 282-3800

Fax: (610) 282-3090

Lutron Electronics Co., Inc., reserves the right to make improvements or changes in its products without prior notice. Although every attempt is made to ensure that this information is accurate and up to date, please check with Lutron to confirm product availability, latest specifications and suitability for your application.

RadioRA®

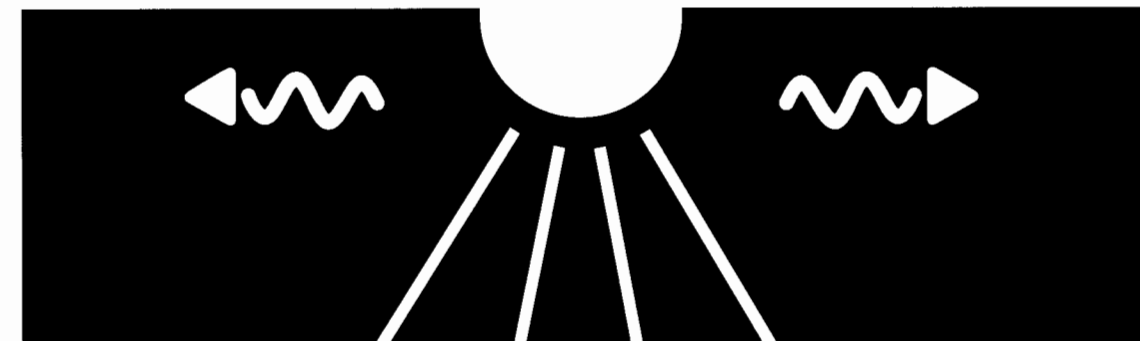

Wireless Home Lighting Control

RAMC-MFE, RBMC-MFE

Setup and Installation Guide For a RadioRA® Multi-Function Entry Master Control

**A Comprehensive Step-by-Step Guide for Installing, Programming,
and Operating the Lutron RadioRA® Multi-Function Entry Master Control**

Note: Please leave this manual with homeowner.

Table of Contents

Section 1 - Overview

Overview

Multi-Function Entry Master Control 4

Application Examples

Activating a "Home" Lighting Scene 6

Controlling a Garage Door 6

Interfacing to a Timeclock 7

Interfacing to a Security System 7

Section 2 - Installation

Installing an Entry Master Control

Installation 8

Section 3 - Start-Up

Activating an Entry Master Control

Activating Control 10

Button Programming

Assigning a Column of Buttons as ROOMS or SCENES 11

Assigning Dimmers, Switches, or GRAFIK Eye® Control Units to Buttons 12

Setting Light Levels/GRAFIK Eye® Scene Selection for Buttons 13

Configuring General CCIs as Maintained or Momentary 14

Entry Master Control Learning a Visor Control 16

Section 4 - Advanced Features

Advanced Programming

Programming the ALL ON Button 18

Programming the ALL OFF Button 18

Copying Button Programming 18

Erasing Button Programming 18

Programming the FULL and FLASH Buttons 19

Deleting ALL Visor Control Transmitters from an Entry Master Control 22

Section 5 - Troubleshooting

Troubleshooting Guide

..... 24

Returning to Default Factory Settings

Entry Master Control 25

Troubleshooting Guide

Proper operation of the RadioRA® Wireless Central Home Lighting Control System is based upon a complex series of radio frequency (RF) communications between system components. As such, it is highly dependent upon proper system installation and programming of controls.

If you experience difficulties programming or operating your RadioRA® system, please refer to this guide. Many symptoms of common system activation or programming errors are contained in this Troubleshooting Guide. If you are having a problem with your system not described here, or if you have any questions, call the **Lutron Technical Support Center** at 1-800-523-9466.

	Symptom	Possible Cause	Remedy
I	ACTIVATE CONTROLS LED on MAIN or AUXILIARY Repeater turns ON and then back OFF when attempting to go into ACTIVATE CONTROLS mode.	Your system has encountered a neighboring system within RF communication range also in ACTIVATE CONTROLS mode.	Discontinue activating your RadioRA® system until activation of the neighboring system is complete.
II	After activating a Multi-Function Entry Master Control, the Multi-Function Entry Master Control LEDs flutter for approximately 5 seconds then go out.	Multi-Function Entry Master Control is out of RF communication range of nearest system Repeater.	Move a system Repeater closer to the Multi-Function Entry Master Control in question, or you may have to add another Repeater.
		System not in ACTIVATE CONTROLS mode.	Place system in ACTIVATE CONTROLS mode.
III	The Multi-Function Entry Master Control appears not to be working at all and the LEDs are OFF.	No power available to the Multi-Function Entry Master Control.	Check that breaker is on and not tripped.
		Faulty power supply.	Verify that the plug in power supply is working.
IV	The Multi-Function Entry Master Control appears not to be working at all and the LEDs are glowing dimly.	The Multi-Function Entry Master Control was not programmed properly.	Reprogram the Multi-Function Entry Master Control.
		The Multi-Function Entry Master Control may be out of RF communication range of the nearest Repeater.	Verify whether the Multi-Function Entry Master Control is in range of a Repeater by placing the system in BEEP mode. (Refer to the Troubleshooting Section in the RadioRA® Setup Guide P/N 044-001.)
V	The Visor Control Transmitter is not communicating with the Multi-Function Entry Master Control.	Entry Master Control failed to learn Visor Control Transmitter.	Entry Master Control must learn Visor Control Transmitter.
		Batteries weak or dead.	Replace batteries in Visor Control Transmitter with new ones (CR2032).

Overview

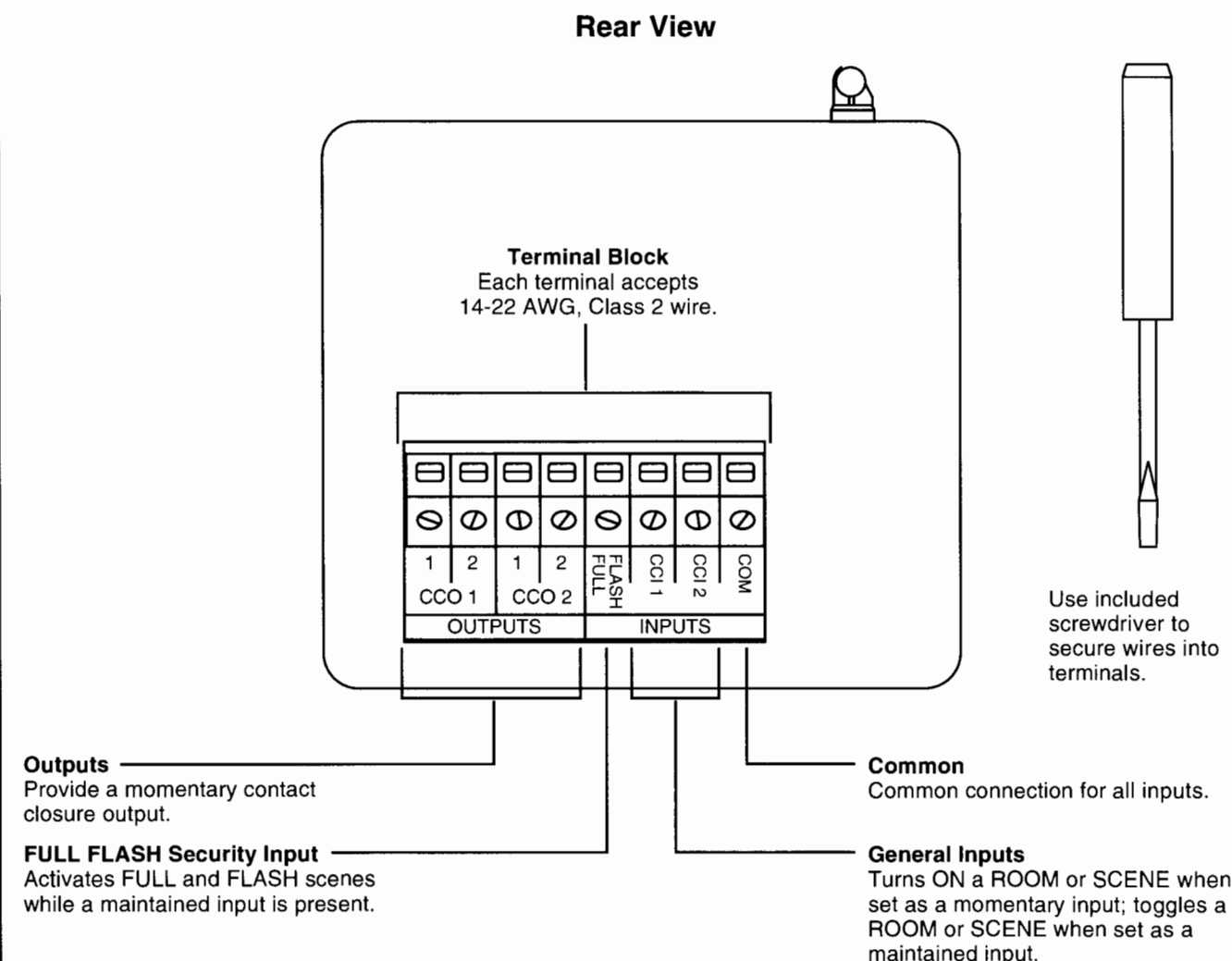

Advanced Programming

Deleting ALL Visor Control Transmitters from an Entry Master Control

! Deleting all Visor Controls from an Entry Master Control will permanently delete all Visor Control Transmitter Buttons previously learned.

Step 1 Begin deleting ALL Visor Controls

Press and hold the LEARN button until its LED turns ON (approximately 3 seconds).

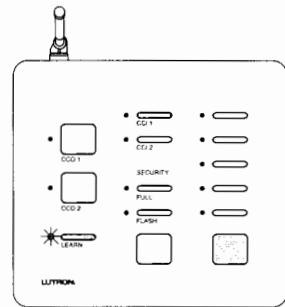
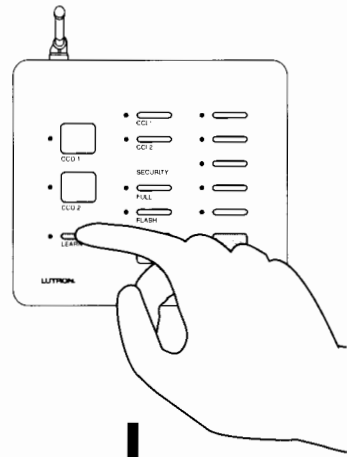

The green LEARN LED turns ON.

Step 2 Delete ALL Visor Controls

Press and hold the CCI 1, FULL, and ALL ON buttons in the middle column until the CCI 1 and FULL LEDs begin to flash (approximately 3 seconds).

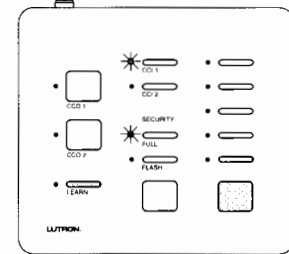
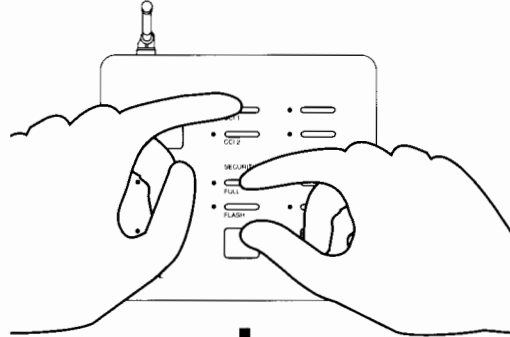

The CCI 1 and FULL LEDs flash.

Overview

Interfacing to a Timeclock

The lighting scene "Sunset" on the Entry Master Control can be activated by either pressing the button labeled "Sunset" or by an input closure on CCI 1.

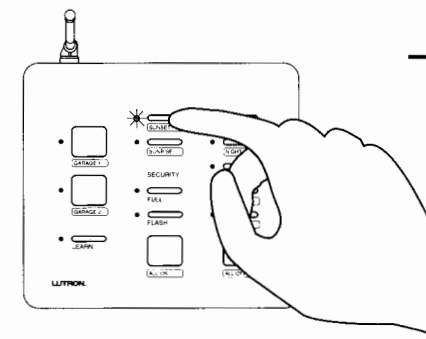

– OR –

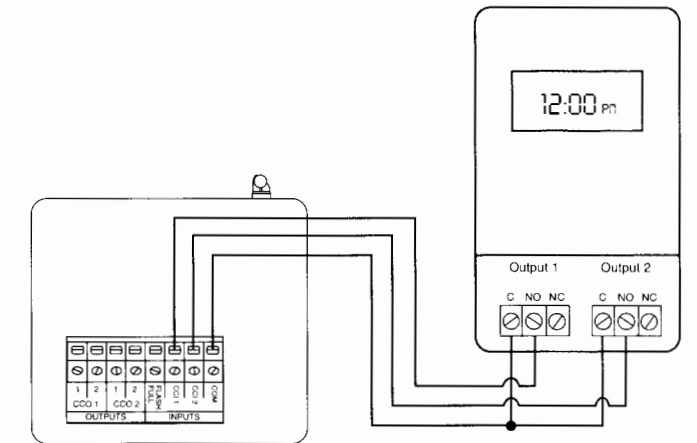

Interfacing to a Security System

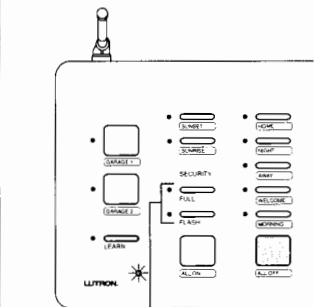

Enter SECURITY Mode by pressing and holding (approximately 3 seconds) the "SECURITY" button on the Visor Control.

– OR –

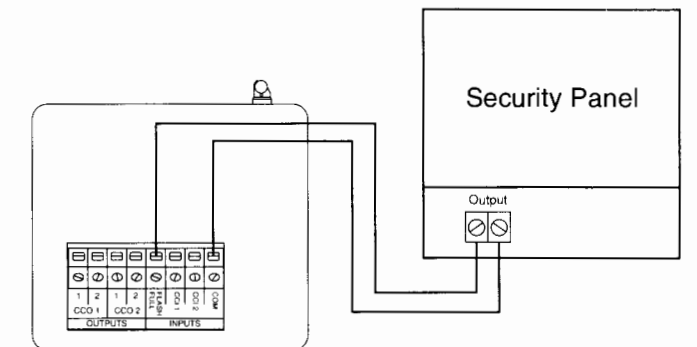
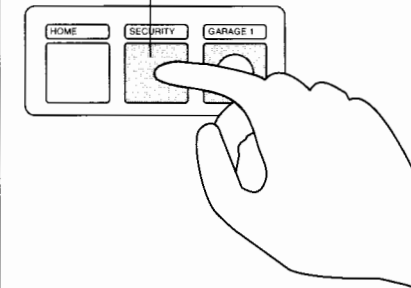

Enter SECURITY Mode with a maintained input closure from a Security System.

- While in SECURITY Mode, dimmers assigned to FULL will turn on to full intensity, dimmers assigned to FLASH will begin flashing.

Step 4 Select FLASH button

Press the FLASH button.

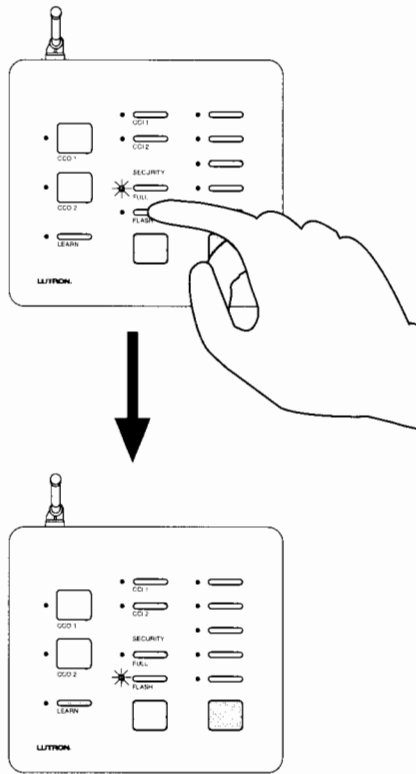

FLASH LED will begin to flash.

Step 5 Assign Dimmers, Switches or GRAFIK Eye® Control Units to the FLASH button

- Dimmers and Switches assigned will flash ON and OFF while in SECURITY Mode.
- GRAFIK Eye® Control Units assigned will alternate between scene 1 and OFF while in SECURITY Mode.

Assign a Dimmer or Switch to the FLASH button by turning the Dimmer or Switch ON.

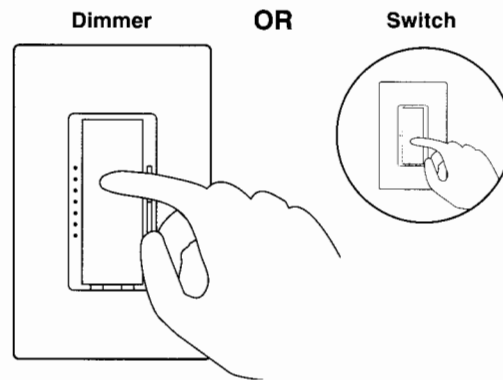

Assign a GRAFIK Eye® Control Unit to the FLASH button by pressing the scene 1 button.

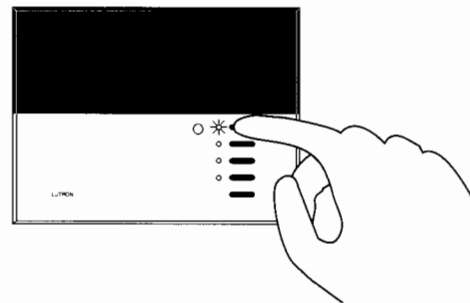

! If you assign the wrong Dimmer, Switch or GRAFIK Eye® Control Unit to the FLASH button, turn the Dimmer, Switch or GRAFIK Eye® Control Unit OFF to unassign it.



Step 4 Attach the AC Adapter

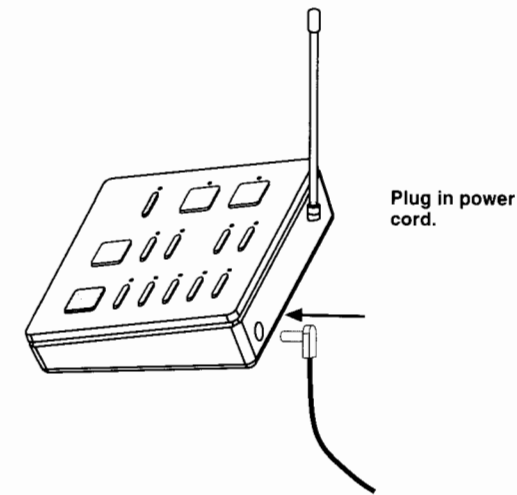

Step 5 Attach to Wall Bracket

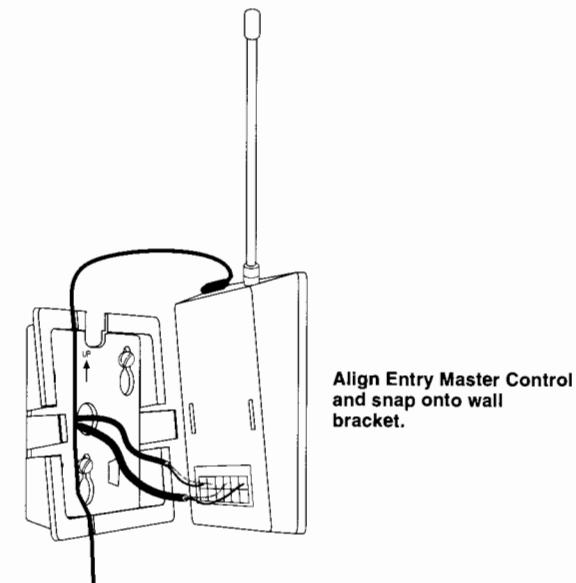

Step 6 Plug in the AC Adapter

Plug the AC Adapter into a 120VAC, 60Hz wall receptacle.

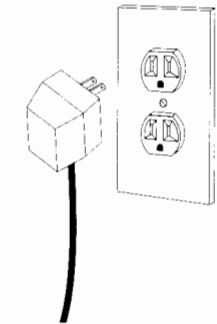

? If the LEDs do not flash when powered, ensure that the AC adapter is installed properly and that there is power at the receptacle. If problem persists, call the Lutron Technical Support Center at (800) 523-9466.

Programming the ALL ON Button

To program the ALL ON button, refer to the RadioRA® Setup Guide, Lutron P/N 044-001, section on "Programming the ALL ON Button."

Programming the ALL OFF Button

To program the ALL OFF button, refer to the RadioRA® Setup Guide, Lutron P/N 044-001, section on "Programming the ALL OFF Button."

Copying Button Programming

To copy button programming from another Master Control button, refer to the RadioRA® Setup Guide, Lutron P/N 044-001, section on "Copying Button Programming."

Erasing Button Programming

To erase button programming from the Entry Master Control, refer to the RadioRA® Setup Guide, Lutron P/N 044-001, section on "Erasing Button Programming."

Assigning a Column of Buttons as ROOMS or SCENES

Step 1 Begin ROOM/SCENE assignment

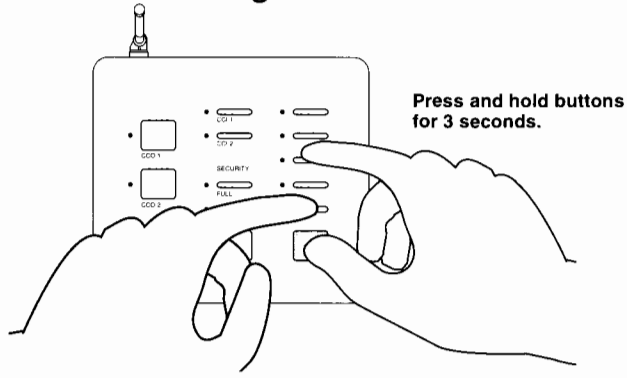

Press and hold buttons for 3 seconds.

Step 2 Change ROOM/SCENE Assignment

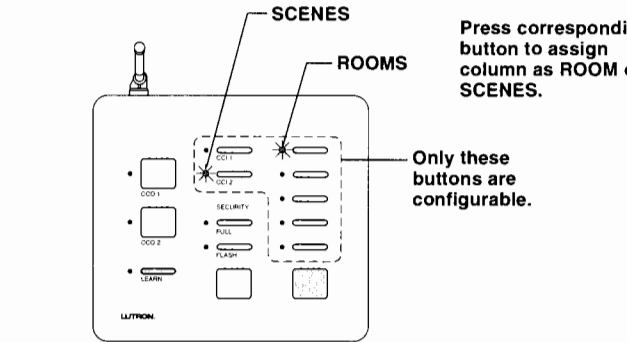

SCENES
ROOMS

Press corresponding button to assign column as ROOM or SCENES.

Only these buttons are configurable.

Step 3 Complete ROOM/SCENE assignment

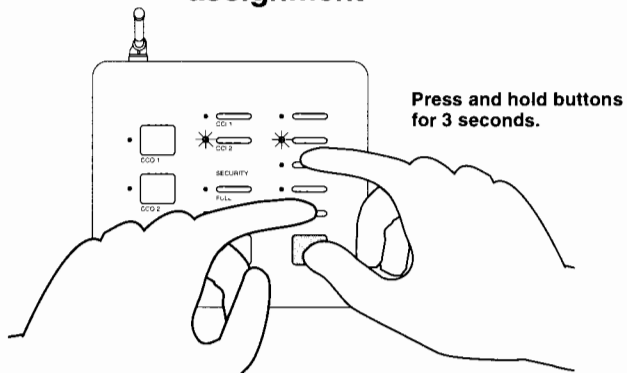

Press and hold buttons for 3 seconds.

? For more detailed information, refer to the RadioRA® Setup Guide (P/N 044-001)

Button Programming

Entry Master Control Learning a Visor Control

Step 1 Plan which Entry Master Control buttons you want to learn Visor Control buttons

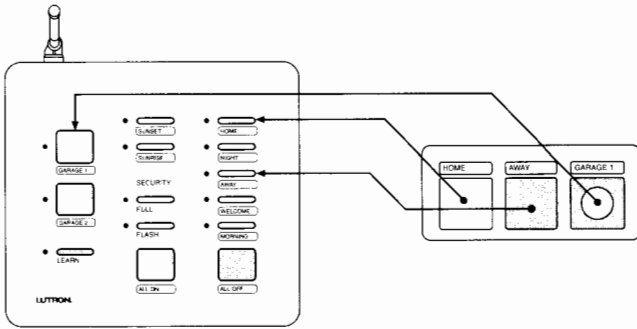

Step 2 Enter LEARN Mode

Press and hold the LEARN button on the Entry Master Control until the green LEARN LED turns ON (approximately 3 seconds).

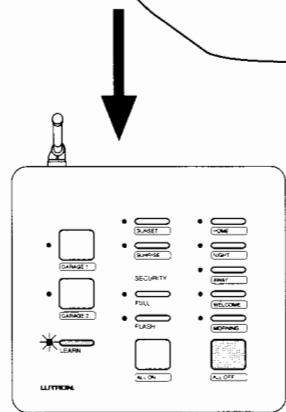
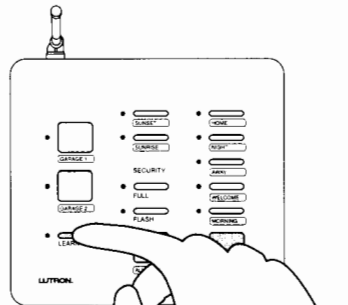

The green LEARN LED turns ON.

Step 3 Select an Entry Master Control Button

Press and release Entry Master Control button that you want to learn a Visor Control button; its LED will turn ON.

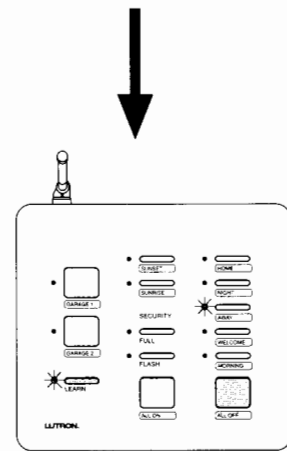
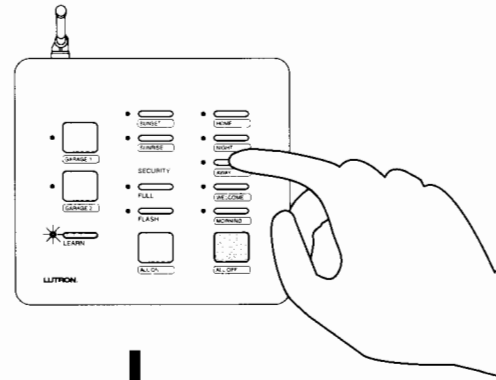

LED turns ON.

- If the ALL ON button is selected, LEDs in the right most column will cycle upward.
- If the ALL OFF button is selected, LEDs in the right most column will cycle downward.
- If either FULL or FLASH is selected, both the FULL and FLASH LEDs will turn ON.

Button Programming

Setting Light Levels/GRAFIK Eye® Scene Selection for Buttons

Step 1 Begin setting light levels

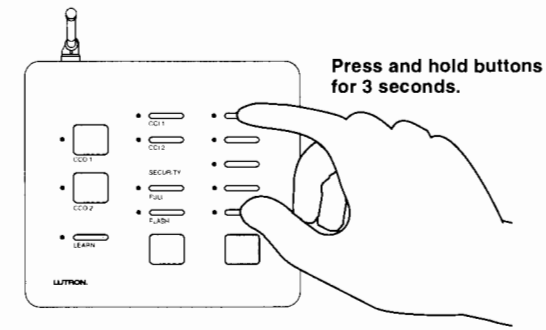

Step 2 Select a button

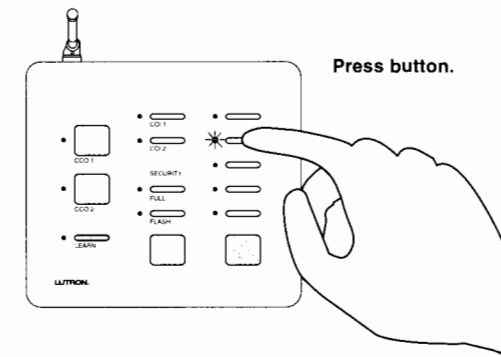

Step 3 Set light levels for Dimmers or GRAFIK Eye® scenes

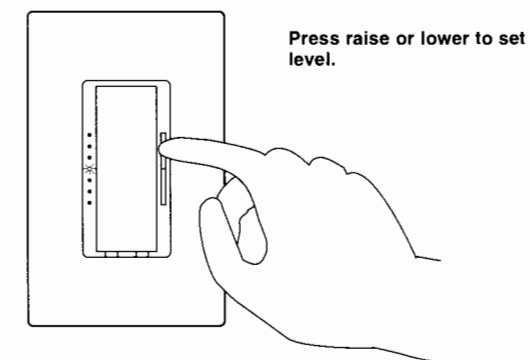

Step 5 Select the next button

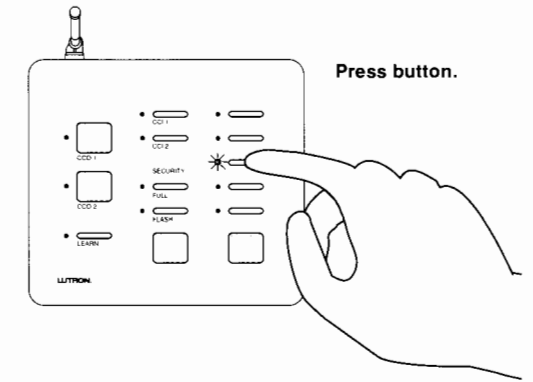

Step 6 Complete setting light levels

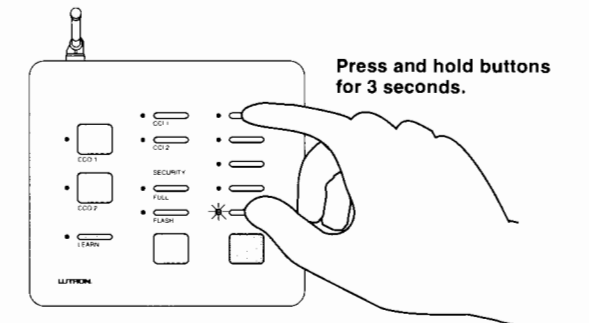

? For more detailed information, refer to the RadioRA® Setup Guide (P/N 044-001)

Configuring General Inputs as Maintained or Momentary

Note: The Security Input is always a maintained CCI.

Step 1 Begin CCI closure type assignment

Simultaneously press and hold the FULL and ALL ON buttons (approximately 3 seconds).

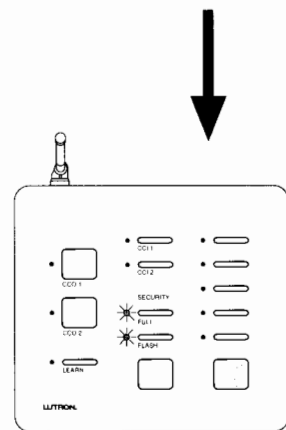
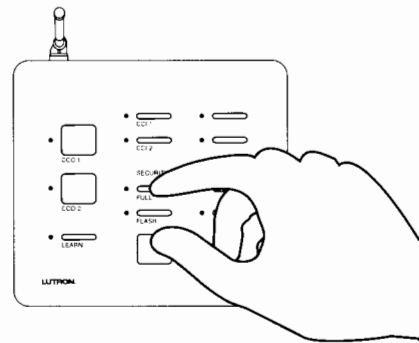

FULL and FLASH LEDs will turn ON.

Step 2 Changing the CCI closure type assignments

Both General CCIs can be independently selected as a Momentary or Maintained closure. Press and hold a CCI button to change its type.

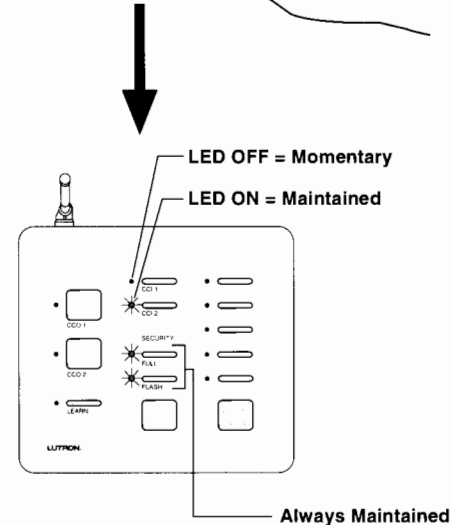
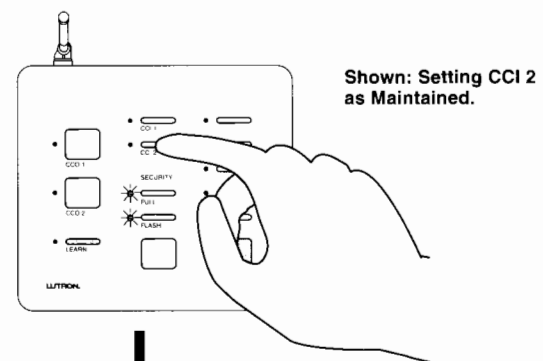

Maintained Input Example

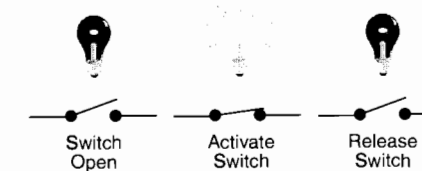

A Maintained switch closure will turn an input ROOM or SCENE ON. Input ROOM or SCENE remains ON until the switch closure is released. When released, the input ROOM or SCENE turns OFF.

Momentary Input Example

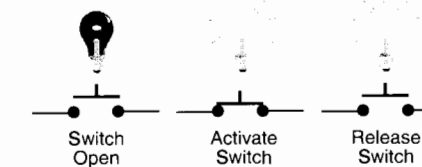

A Momentary switch closure will turn an input ROOM or SCENE ON. A momentary switch closure **cannot** turn an input ROOM or SCENE OFF.

Step 3 Complete CCI closure type assignment

Simultaneously press and hold the FULL and ALL ON buttons (approximately 3 seconds).

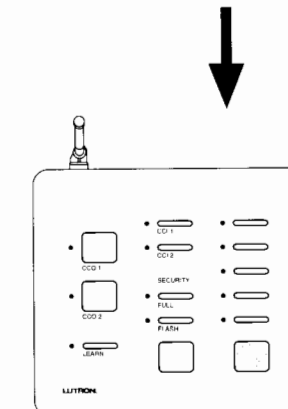
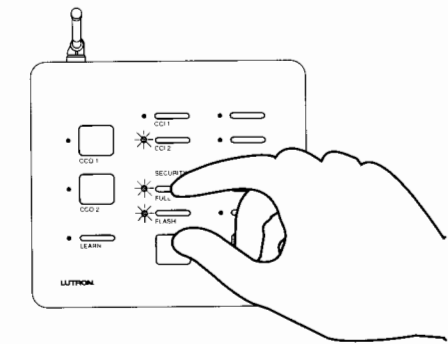

All LEDs will turn OFF.

Button Programming

Assigning Dimmers, Switches, or GRAFIK Eye® Control Units to Buttons

Step 1 Begin assigning

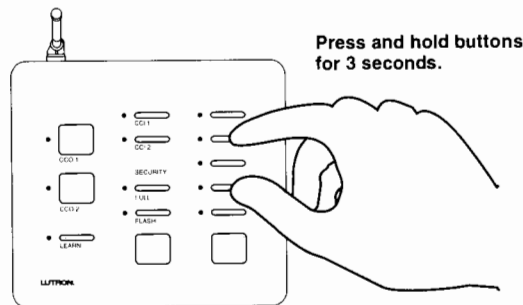

Step 2 Select a button

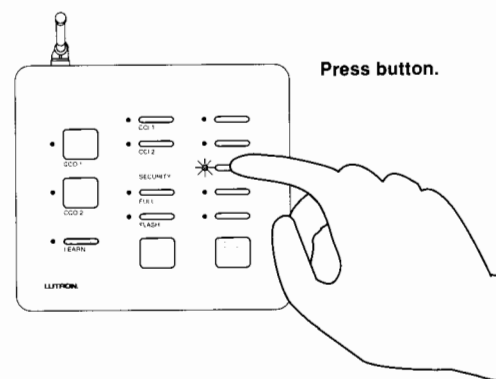

Step 3 Assign a Dimmer, Switch or GRAFIK Eye® Control Unit to the button

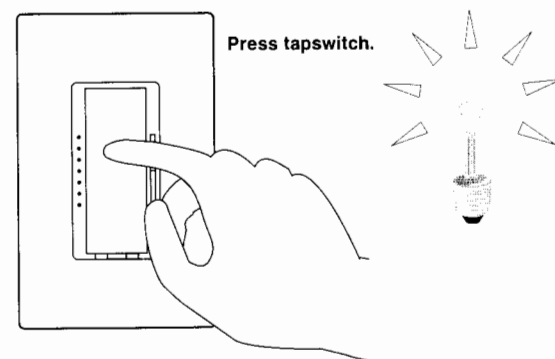

Step 4 Select next button

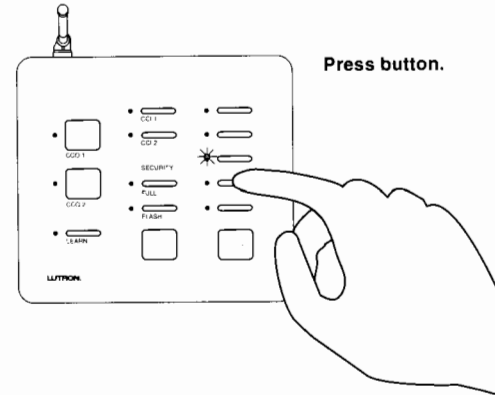

Step 5 Complete assigning

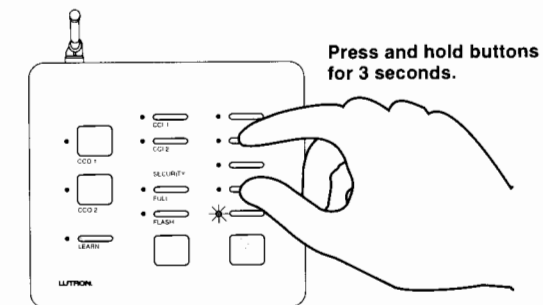

? For more detailed information, refer to the RadioRA® Setup Guide (P/N 044-001)

Button Programming

Step 4 Select Visor Control Button to be learned by the Entry Master Control

Press and hold the Visor Control Button until the orange LED next to the selected Entry Master Control button flashes (approximately 3 seconds). The LEARN LED will also flash while the Visor Control button is pressed.

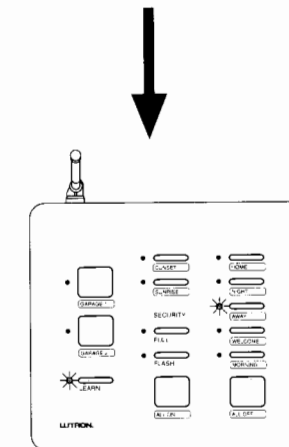
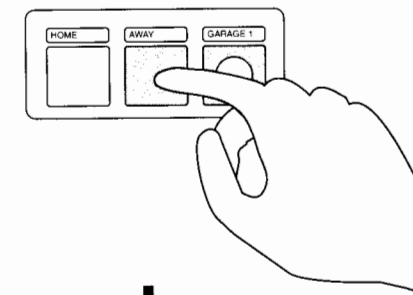

The orange LED will turn OFF after the Visor Control button is released. The green LEARN LED will stay ON.

- To verify that the Entry Master Control button has learned the Visor Control button, press the Visor Control button again. The orange LED on the Entry Master Control will flash.

Step 5 Repeat Steps 3 and 4 to learn additional Visor Control buttons

Step 6 Exit LEARN Mode

Press the LEARN button.

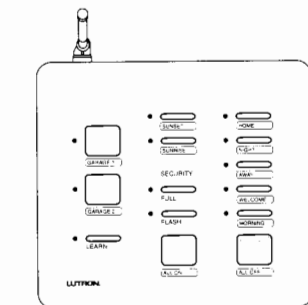
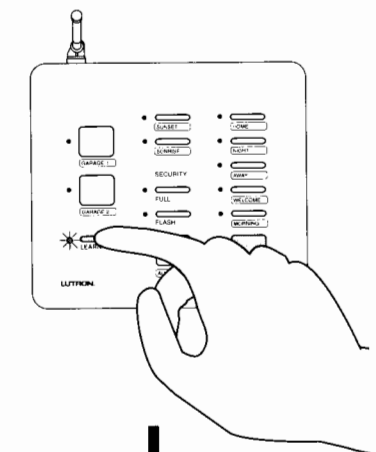

The green LEARN LED turns OFF.

Activating an Entry Master Control

Activating Control

The Entry Master Control is a type of Master Control. The RadioRA® System can have a maximum of 12 Master Controls.

Step 1 Begin Control activation

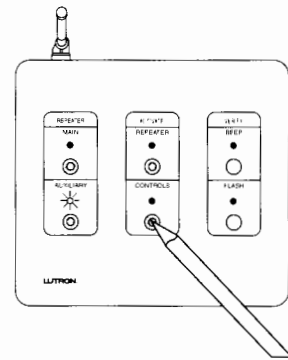

Press and hold button for 3 seconds.

Step 2 Activate Entry Master Control

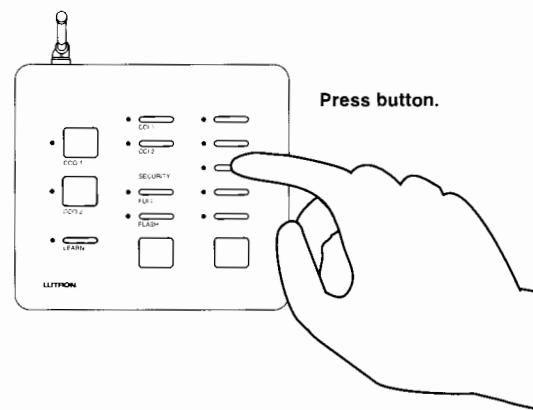

Press button.

Step 3 Complete Control activation

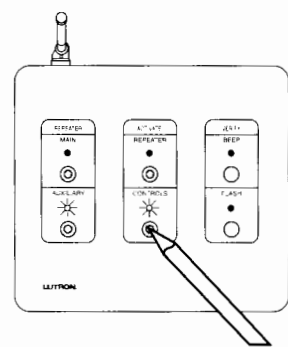

Press and hold button for 3 seconds.

? For more detailed information, refer to the RadioRA® Setup Guide (P/N 044-001)

Advanced Programming

Programming the FULL and FLASH Buttons

! The Security FULL and FLASH buttons are used for programming and diagnostic purposes only.

Step 1 Begin FULL and FLASH button programming

Simultaneously press and hold the 2nd and 4th buttons in the right most column until the upper right LED begins to flash (approximately 3 seconds).

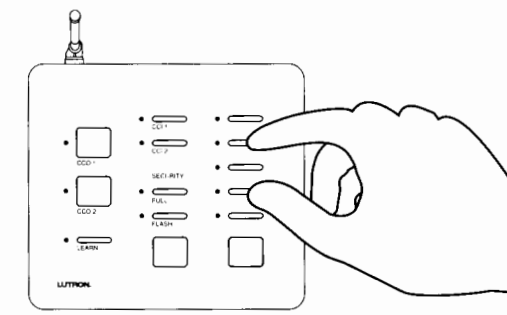

Upper right LED flashes.

Step 2 Select the FULL Button

Press the FULL button.

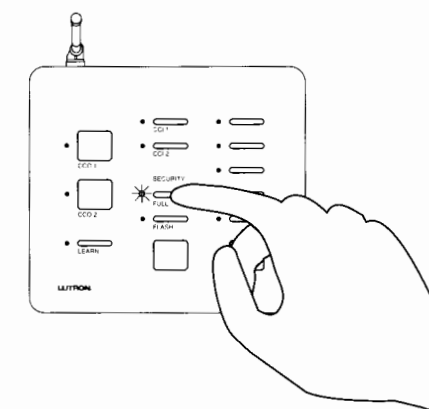

FULL LED will begin to flash.

Step 3 Assign Dimmers, Switches or GRAFIK Eye® Control Units to the FULL button

- Dimmers and Switches assigned will turn on to full while in SECURITY Mode.
- GRAFIK Eye® Control Units assigned will go to scene 1 while in SECURITY Mode.

Assign a Dimmer or Switch to the FULL button by turning the Dimmer or Switch ON.

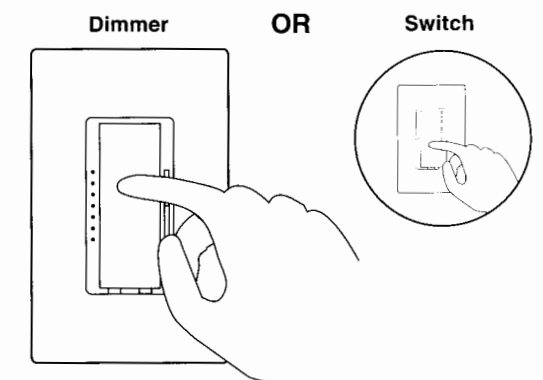

Assign a GRAFIK Eye® Control Unit to the FULL button by pressing the scene 1 button.

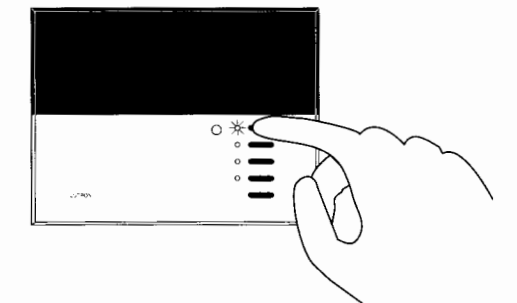

! If you assign the wrong Dimmer, Switch or GRAFIK Eye® Control Unit to the FULL button, turn the Dimmer, Switch or GRAFIK Eye® Control Unit OFF to unassign it.

• Continued on next page.

Installing an Entry Master Control

Installation

Read all instructions completely before installation.

Step 1 Find a suitable location for the Entry Master Control

Place the Entry Master Control in a convenient and accessible location. Access to input and output wiring should be considered when selecting the mounting location.
Note: Entry Master Control must be located within 30 feet of a Repeater. For optimum Visor Control range, the Entry Master Control should be located in or near the garage.

Step 2 Mount Wall Bracket

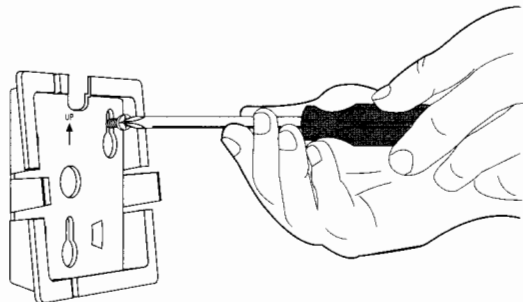

Attach wall bracket to wall using the supplied screws and wall anchors.

Step 3 Wiring to input and output devices.

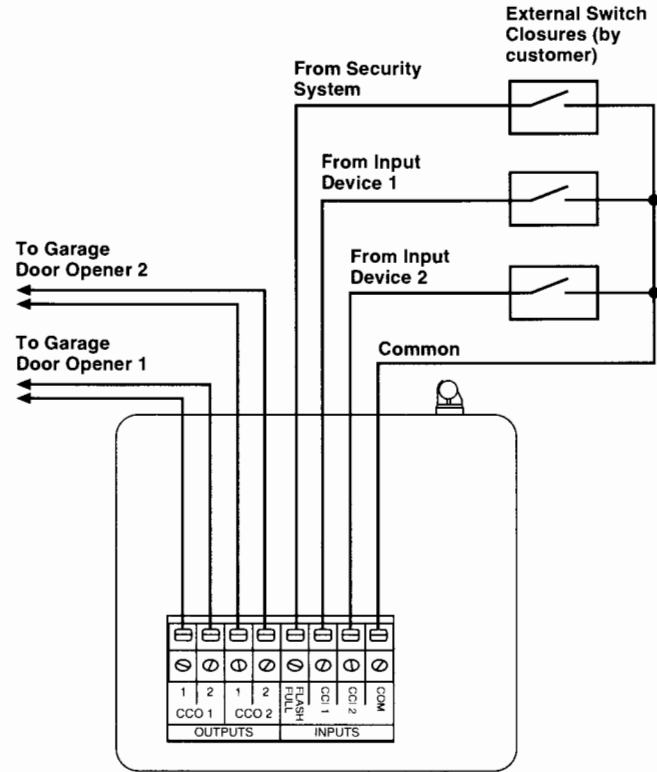

Note:
• Input devices can be timeclocks, motion sensors, telephone interfaces, etc.



DANGER -

- Do not connect line voltage power to the Entry Master Control.
- Connecting line voltage power or improper wiring can result in personal injury or damage to the control or to other equipment.
- All external control equipment must maintain Class 2 isolation.

Advanced Programming

Step 6 Complete FULL and FLASH button programming

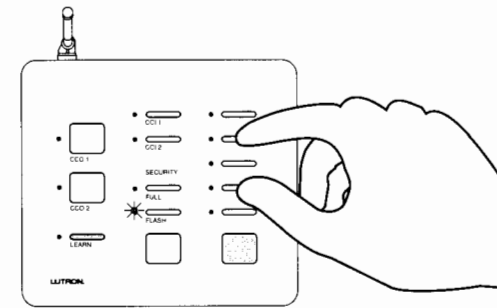

Simultaneously press and hold the 2nd and 4th buttons in the right most column until all the LEDs begin to flutter (approximately 3 seconds).

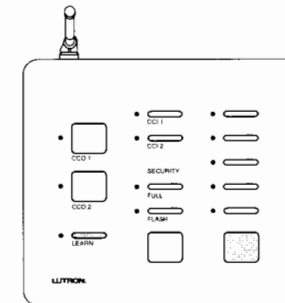

Application Examples

Activating a "Home" Lighting Scene

Pressing the "Home" button on the Entry Master Control activates the "Home" lighting scene.

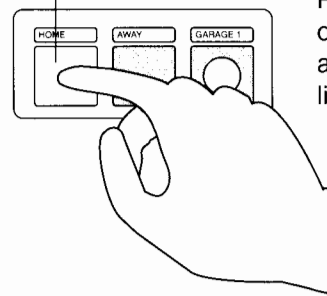
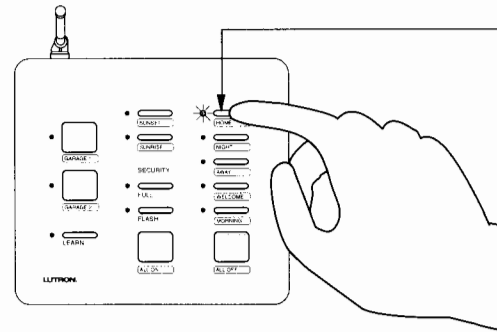

- OR -
Pressing the "Home" button on the Visor Control activates the same "Home" lighting scene.

Controlling a Garage Door

Pressing the button labeled "Garage 1" closes the contact of CCO 1 to open or close the garage door.

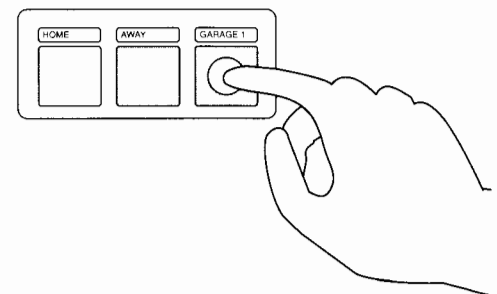
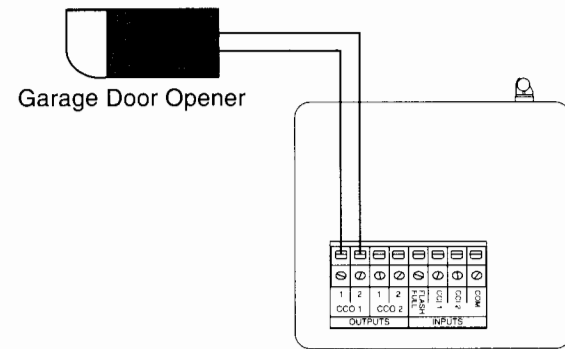
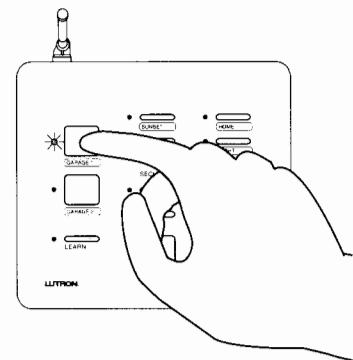

- OR -
Pressing the "Garage 1" button on the Visor Control will also open or close the garage door.

While the CCI 1 and FULL LEDs are flashing, press and hold the CCI 2 and FLASH buttons in the middle column until all the LEDs flash.

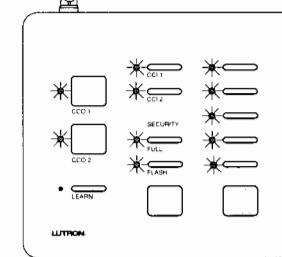
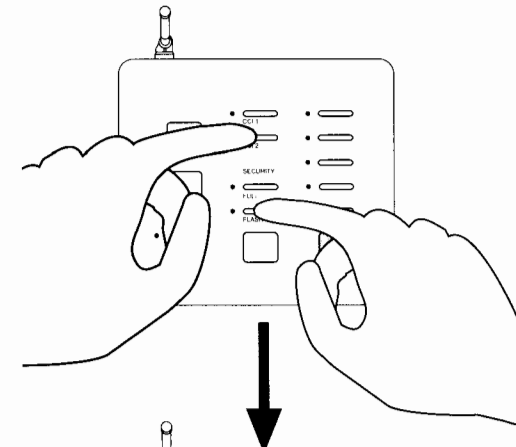

All LEDs (except the LEARN) flutter.

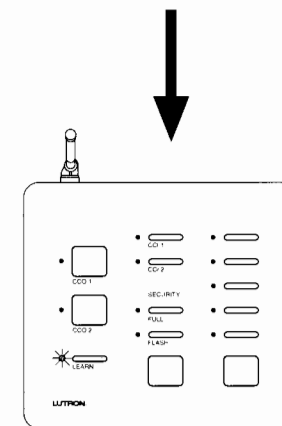

All LEDs will turn OFF (except the LEARN), indicating that ALL Visor Controls have been deleted from the Entry Master Control.

Step 3 Complete deleting ALL Visor Controls

Press the LEARN button.

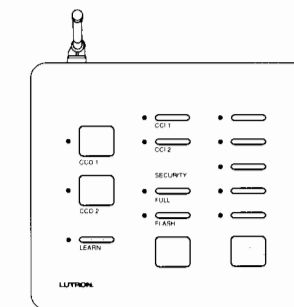
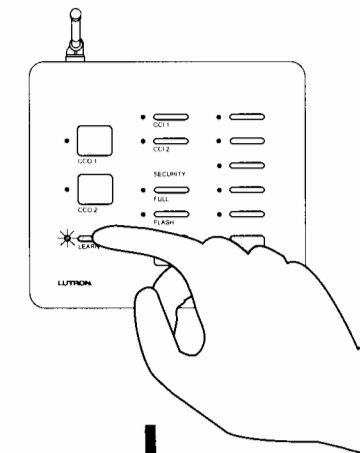

The green LEARN LED turns OFF.

Multi-Function Entry Master Control

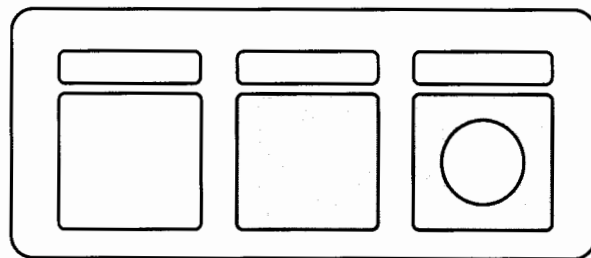
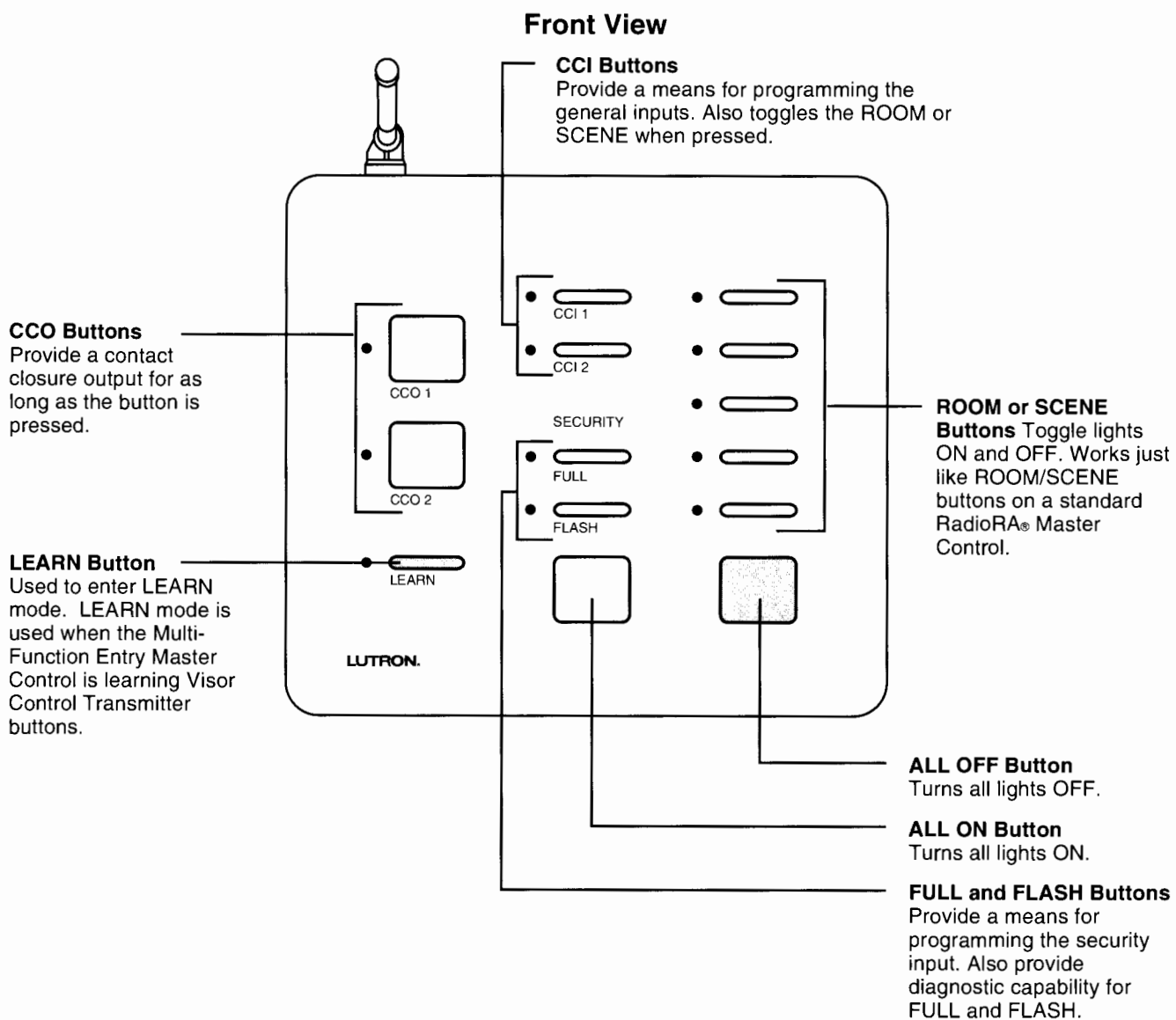

Visor Control Transmitter (sold separately)

- Mounts to a vehicle's visor.
- Buttons provide a means for remotely activating buttons on the Entry Master Control.
 - Turn on an Entry Master Control SCENE
 - Toggles an Entry Master Control ROOM
- SECURITY FULL and FLASH
 - To enter, press and hold Visor Control button setup as security button for 3 seconds.
 - To exit, just press any button on the Visor Control.

Returning to Default Factory Settings

Entry Master Control

! Returning an Entry Master Control to Default Factory Settings will permanently delete all current programming information. **Do not do this unless you are sure that it is necessary.** For more information call the **Lutron Technical Support Center at 1-800-523-9466.**

Step 1 Begin returning to Default Factory Settings

! Ensure that the ACTIVATE REPEATER LED and ACTIVATE CONTROLS LED on any Repeater is **NOT ON** before proceeding. If either LED is ON, press the corresponding button until its LED turns OFF (approximately 3 seconds).

Press and hold the 1st, 3rd and 5th buttons in the right most column until the corresponding LEDs begin to flash (approximately 3 seconds).

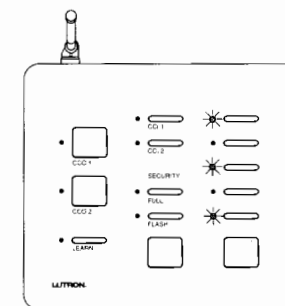
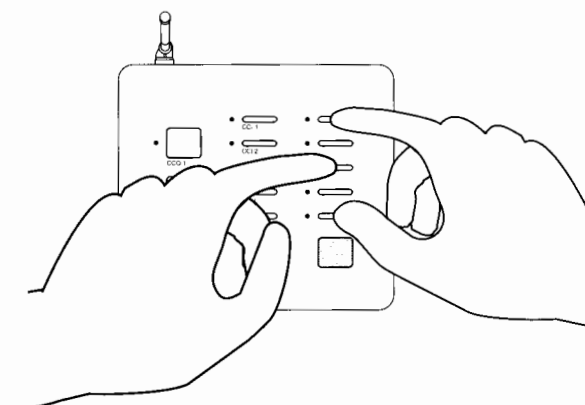

LEDs will flash for only 3 seconds.

Step 2 Complete returning to Default Factory Settings

While the 1st, 3rd, and 5th LED are flashing, press and hold the 2nd and 4th buttons in the right most column until all the LEDs (except the LEARN) flash (approximately 3 seconds).

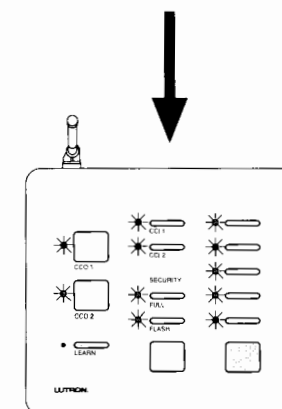
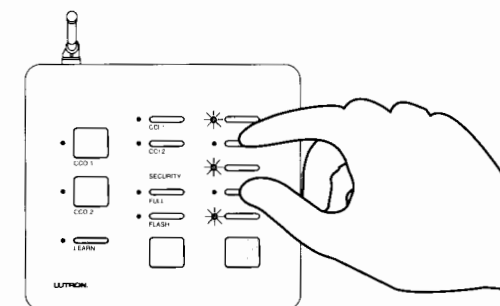

All LEDs (except the LEARN) flash.

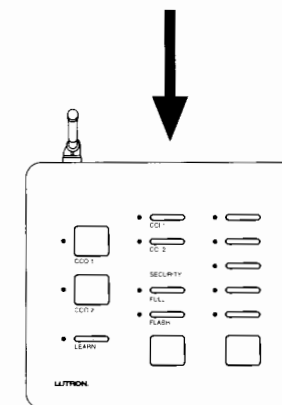

All LEDs will turn OFF, indicating that the Master Control has been returned to Default Factory Settings.

Notes on this Manual

The procedures to setup a RadioRA® Multi-Function Entry Master Control are contained in this manual. For more information on programming the remainder of your RadioRA® System, or for advanced features, refer to the original RadioRA® Setup Guide (P/N 044-001).

Important Application Note

The Multi-Function Entry Master Control is a type of Master Control. The RadioRA® System can have a maximum of 12 Master Controls.

Important Installation Notes

1. Install in accordance with all national and local electrical codes.
2. Do not paint the Multi-Function Entry Master Control.
3. Operate in ambient temperatures between 0°C (32°F) and 40°C (104°F).
4. Do not mount outside. Unit must not get wet.
5. Use only the AC adapter provided by Lutron with your Multi-Function Entry Master Control. Using an AC adapter not rated at the following specifications could damage the control and possibly overheat the AC adapter.
 - Input: AC 120V 60Hz
 - Output: AC 9V/500mA Class 2
6. The range and performance of the RadioRA® System is highly dependent on a variety of complex factors such as:
 - Distance between system components
 - Geometry of the home
 - Construction of walls separating system components
 - Electrical equipment located near system components

Consumer Information

Notice

This Visor Control System, consisting of a Multi-Function Entry Master Control and a Visor Control transmitter, must only be used to operate **visible** means of barrier entry such as garage doors and motorized gates. Do not use this Multi-Function Entry Master Control with any garage door opener that lacks the safety stop and reverse feature as required by federal safety standards. (This includes any garage door opener model manufactured before April 1, 1982.) A garage door opener which cannot detect an object, signaling the door to stop and reverse, does not meet current federal safety standards. Using a garage door opener without these features increases risk of serious injury or death.

Warning

This RadioRA® system must not be used to control equipment, other than lighting, which is **not visible** from every master or local control location. It also must not be used to control equipment which could create hazardous situations such as entrapment if operated accidentally. Examples of equipment which must not be controlled by this RadioRA® system when **not visible** from a Multi-Function Entry Master Control or local control location include (but are not limited to) motorized gates, garage doors, industrial doors, and microwave ovens, heating pads, etc. It is the installer's responsibility to ensure that the equipment, other than lighting, being controlled is **visible** from every master or local control location and that only suitable equipment is connected to this RadioRA® system.

FCC Information

NOTE: This equipment has been tested and found to comply with the limits for a Class B digital device, pursuant to part 15 of the FCC rules. These limits are designed to provide reasonable protection against harmful interference in a residential installation. This equipment generates, uses and can radiate radio frequency energy and, if not installed and used in accordance with the instructions, may cause harmful interference to radio or television reception, which can be determined by turning the equipment off and on, the user is encouraged to try to correct the interference by one or more of the following measures:

- Reorient or relocate the receiving antenna.
- Increase the separation between the equipment and receiver.
- Connect the equipment into an outlet on a circuit different from that to which the receiver is connected.
- Consult the dealer or an experienced radio/TV technician for help.

Caution: Changes or modifications not expressly approved by Lutron Electronics Co. could void the user's authority to operate this equipment.