RadioRA®



Wireless Home Lighting Control

RA-SVC, RB-SVC

Setup and Installation Guide For a RadioRA® Sivoia™ Control

A Comprehensive Step-by-Step Guide for Installing, Programming,
and Operating the Lutron RadioRA® Sivoia™ Control

Note: Please leave this manual with homeowner.

English

P/N 044-025

Notes on this Manual

The procedures to setup a RadioRA® Sivoia™ Control are contained in this manual. For more information on programming the remainder of your RadioRA® System, or for advanced features, refer to the original RadioRA® Setup Guide (P/N 044-001).

Important Application Notes

1. The RadioRA® Sivoia™ Control will use one dimmer address. The RadioRA® System can have a maximum of 32 dimmers or local controls.
2. It is recommended that any additional controls added to a Sivoia™ link with a RadioRA® Sivoia™ Control should be Sivoia™ group controls. Individual Sivoia™ controls will not provide the RadioRA® Sivoia™ Control with proper LED feedback, which will also affect Master Controls.
Acceptable controls are:
Sivoia™ Keypads: SV-1PG, SV-3PG
Sivoia™ Infrared Controls: SV-OCIT, SV-3PIT
Sivoia™ Contact Closure Interface: SV-CCI-GRP
3. By default, RadioRA® Sivoia™ Controls are not assigned to ALL ON or ALL OFF Master Control buttons. To add a RadioRA® Sivoia™ Control to an ALL ON or ALL OFF button, see Section 4 - Adding a RadioRA® Sivoia™ Control to an ALL ON or ALL OFF button.
4. When a RadioRA® Sivoia™ Control is programmed to a Security Full/Flash input, it will have the following function:
 - Full - Window treatment(s) will open, and the Open LED will turn ON.
 - Flash - Window treatment(s) will close, and the Open and Close LEDs will flash alternately.While in a security mode, the Control is disabled and will ignore commands from a RadioRA® Master Control.
5. The Sivoia™ Motor Drive Unit must remain at its default Room Address (1) and Control Station (0) settings for proper operation and LED feedback.
6. Sivoia™ Motor Drive Units (MDUs) with code revision 5.0 or higher are preferred for operation with the RadioRA® Sivoia™ Control. The code revision can be read while MDUs are powering up. MDUs will display "88" for about five seconds, then display the code revision (before 2.0, only the code revision will be displayed). For MDU code revisions before 5.0:
 - Presets will always be unlocked (default) if power to the Sivoia™ Control is lost.
 - All LEDs will remain OFF when the Raise or Lower buttons are used or when the window treatment(s) are stopped while going to a Preset. A RadioRA® Master Control ROOM button assigned to the RadioRA® Sivoia™ Control will remain ON when the window treatment(s) are closed with the Lower button. The Close preset must be activated to cause the ROOM LED to turn OFF.

Important Installation Notes

1. Install in accordance with all national and local electrical codes.
2. Do not paint the RadioRA® Sivoia™ Control.
3. Operate in ambient temperatures between 0°C (32°F) and 40°C (104°F).
4. Do not mount outside. Unit must not get wet.
5. The range and performance of the RadioRA® System is highly dependent on a variety of complex factors such as:
 - Distance between system components
 - Geometry of the home
 - Construction of walls separating system components
 - Electrical equipment located near system components

Consumer Information

Warning

This RadioRA® system must not be used to control equipment, other than lighting or window treatments, which is **not visible** from every master or local control location. It also must not be used to control equipment which could create hazardous situations such as entrapment if operated accidentally. Examples of equipment which must not be controlled by this RadioRA® system include (but are not limited to) motorized gates, garage doors, industrial doors, and microwave ovens, heating pads, etc. It is the installer's responsibility to ensure that the equipment, other than lighting or window treatments, being controlled is **visible** from every master or local control location and that only suitable equipment is connected to this RadioRA® system.

FCC Information

NOTE: This equipment has been tested and found to comply with the limits for a Class B digital device, pursuant to part 15 of the FCC rules. These limits are designed to provide reasonable protection against harmful interference in a residential installation. This equipment generates, uses and can radiate radio frequency energy and, if not installed and used in accordance with the instructions, may cause harmful interference to radio or television reception, which can be determined by turning the equipment off and on, the user is encouraged to try to correct the interference by one or more of the following measures:

- Reorient or relocate the receiving antenna.
- Increase the separation between the equipment and receiver.
- Connect the equipment into an outlet on a circuit different from that to which the receiver is connected.
- Consult the dealer or an experienced radio/TV technician for help.

Caution: Changes or modifications not expressly approved by Lutron Electronics Co. could void the user's authority to operate this equipment.

Table of Contents

Section 1 - Overview

Operation

RadioRA® Sivoia™ Control	4
--------------------------------	---

Section 2 - Installation

Installing a Sivoia™ Control

Installation	5
--------------------	---

Section 3 - Start-Up

Adding a RadioRA® Sivoia™ Control

Activating the Control	7
------------------------------	---

Changing Preset Levels	9
------------------------------	---

Master Control Button Programming

Assigning a Sivoia™ Control to Master Control Buttons	10
---	----

Setting Sivoia™ Presets for Master Control Buttons	12
--	----

Section 4 - Advanced Programming

Additional Features

Setting a SCENE button as a Stop button	14
---	----

Adding a RadioRA® Sivoia™ Control to an ALL ON or ALL OFF button	16
--	----

Default Settings

Changing Default Settings	18
---------------------------------	----

Section 5 - Troubleshooting

<i>Troubleshooting Guide</i>	20
------------------------------------	----

Returning to Default Factory Settings

RadioRA® Sivoia™ Control	22
--------------------------------	----

RadioRA® Sivoia™ Control

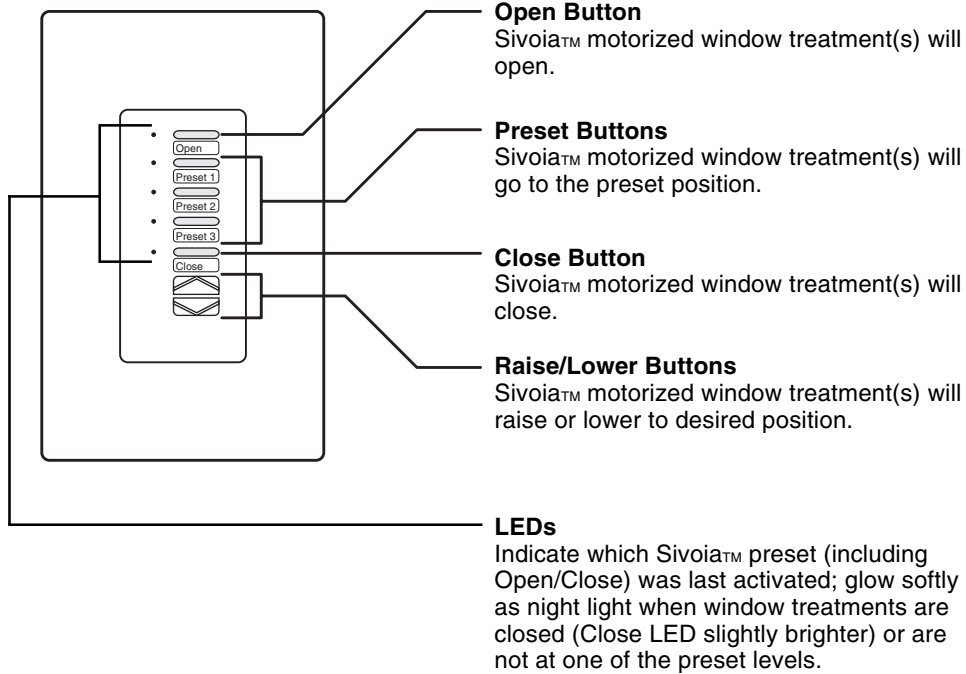

Notes:

- To stop the window treatment(s) after pressing a preset button (including Open/Close), press the same button again.
- Button labels shown on the Sivoia™ Control throughout this Setup Guide are only to show the functionality of these buttons. Apply labels from the provided label sheet during installation and setup.

Installing a Sivoia™ Control

Installation

Read all instructions completely before installation.

Step 1 Find a suitable location for the Sivoia™ Control

The Sivoia™ Control must be located within 30 feet of an RF Signal Repeater.

Step 2 Turn power OFF

For Sivoia™ Motor Drive Units with plug-in transformers, unplug the transformer. Otherwise, turn power OFF at circuit breaker panel or remove fuse from fusebox.

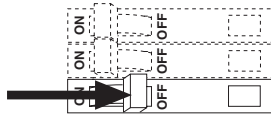

Step 3 Wiring the Sivoia™ Control

Using the wire connectors provided, wire the Control as per the wiring diagram.

- Connect the **blue** wire to terminal 3 (MUX) on the Sivoia™ MDU.
- Connect the **white/black** wire to terminal 4 (COM) on the Sivoia™ MDU.
- Connect the **yellow** wire to terminal 5 (MUX) on the Sivoia™ MDU.
- Connect one of the **red** wires to terminal 6 (AC2) on the Sivoia™ MDU.
- Connect the other **red** wires to terminal 8 (AC1) on the Sivoia™ MDU.

Important Wiring Information

When making wire connections, follow the recommended strip lengths and combinations for the supplied wire connectors. **Note:** Wire connectors provided are suitable for **copper wire only**. For aluminum wire, consult an electrician.

Strip insulation 1/4" for 16 or 18 AWG wire
Strip insulation 3/8" for 20 or 22 AWG wire.

Use to join two 16, 18, 20, or 22 AWG wires.

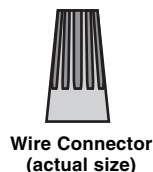

*Twist wire connector tight.
Be sure no bare wire is exposed.*



Wiring Diagram

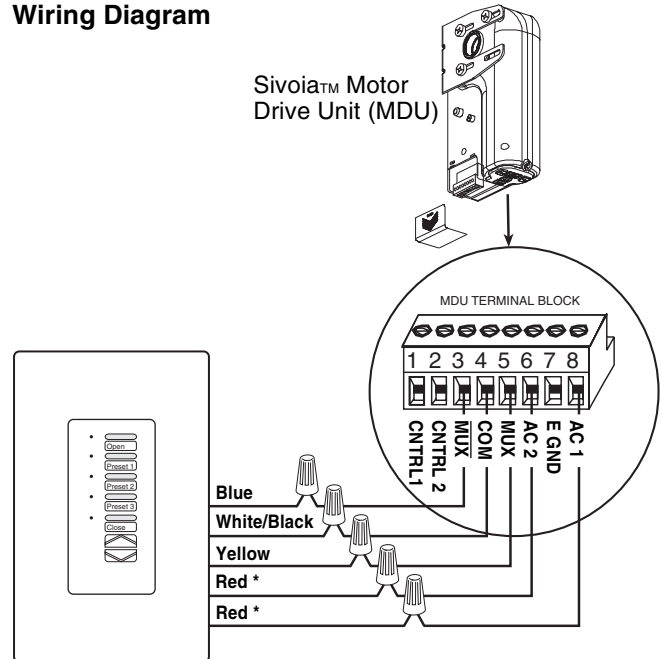

* Power wiring for the RadioRA® Sivoia™ Control can be spliced into the Sivoia™ MDU AC wiring from the transformer or wired directly into the MDU terminal block.

Notes:

1. Wire must be at least 24AWG and may not be longer than 200 feet. (Recommended Lutron cable: SV-CBL-MDU-250)
2. To connect more than one Sivoia™ MDU to the RadioRA® Sivoia™ Control, wire only terminals 3, 4, and 5 (MUX, COM, MUX) of the MDUs together.



DANGER -

- Do not connect line voltage power to the Sivoia™ Control.
- Connecting line voltage power or improper wiring can result in personal injury or damage to the control or to other equipment.
- All external control equipment must maintain Class 2 isolation.
- Sivoia™ Controls can only be ganged with other Class 2 devices. Line voltage devices must use a separate wallbox.

• Continued on next page.

Installing a Sivoia™ Control

Step 4 Mount Control

Attach wallplate adapter. Mount and align control. Snap on Claro® wallplate (purchased separately).

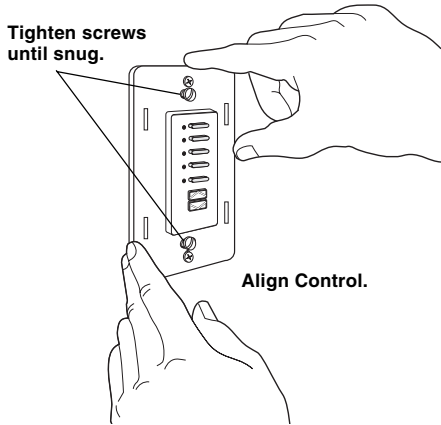

Snap on wallplate.

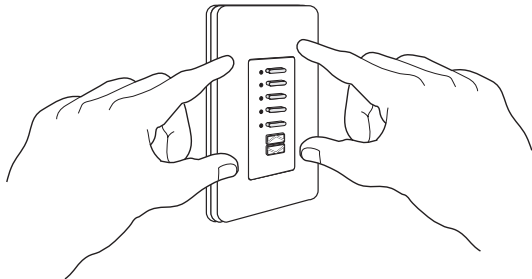

Step 5 Turn power ON

Plug the Sivoia™ Motor Drive Unit transformer back in, or turn power ON at circuit breaker panel, or replace the fuse.

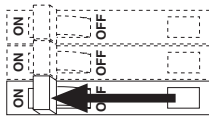

Step 6 Test Sivoia™ Control operation

After setting the limits for each Sivoia™ Motor Drive Unit (see the Sivoia™ MDU instructions), test the operation of the Sivoia™ Control.

Press the Open button.

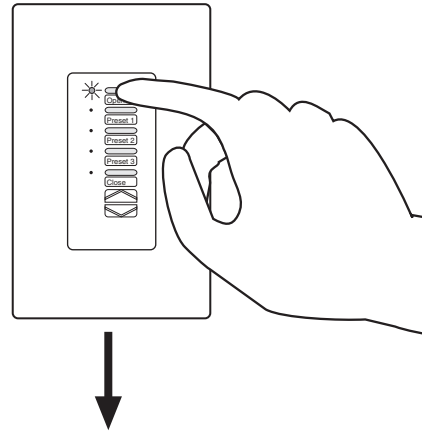

Window treatment(s) should open.

Press the Close button.

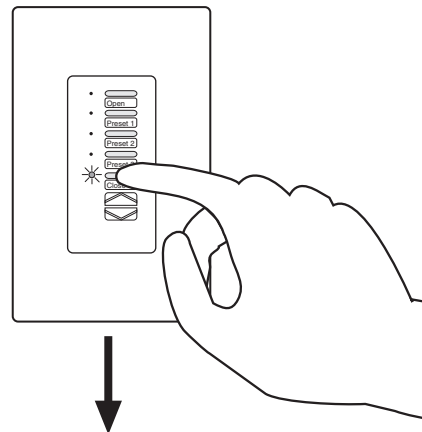

Window treatment(s) should close.



If window treatment(s) fail to respond to button presses, consult the Troubleshooting Guide on page 20.

Adding a RadioRA® Sivoia™ Control

Activating the Control

The RadioRA® Sivoia™ Control counts toward the RadioRA® System maximum of 32 dimmers or local controls.

Step 1 Begin Control activation

Press and hold the ACTIVATE CONTROLS button on **any** Repeater until the green ACTIVATE CONTROLS LED turns ON (approximately 3 seconds).

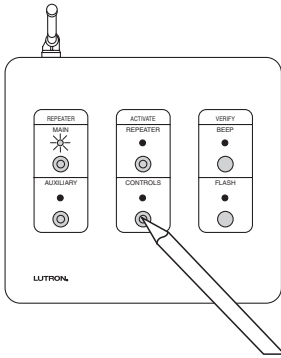

The green ACTIVATE CONTROLS LED on **ALL** Repeaters will turn ON.

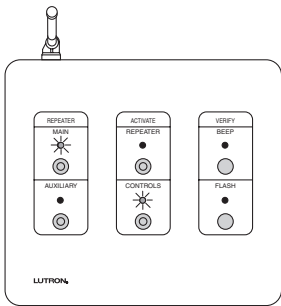

? If the Activate Controls LED fails to turn ON, consult the Troubleshooting Guide on page 20.

Step 2 Activate Sivoia™ Control

Press any button.

- Window treatment(s) will start to move according to the button press.
- Top and bottom LEDs will flash alternately.

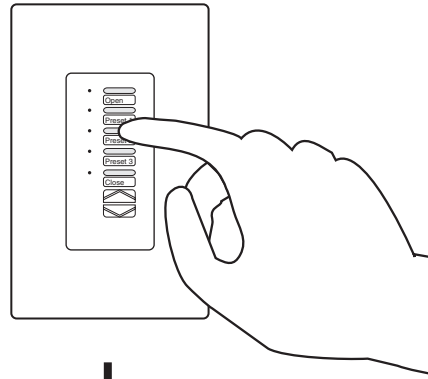

LED of button pressed will turn ON when Sivoia™ Control has been activated, and window treatment(s) will move to the corresponding level.

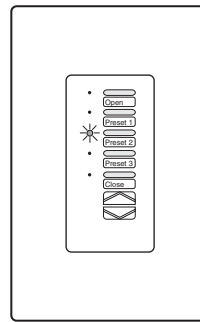

? If a Sivoia™ Control fails to respond as described above, consult the Troubleshooting Guide on page 20.

• Continued on next page.

Adding a RadioRA® Sivoia™ Control

Step 3 Complete Control activation

Press and hold the ACTIVATE CONTROLS button on any Repeater until the green ACTIVATE CONTROLS LED turns OFF (approximately 3 seconds).

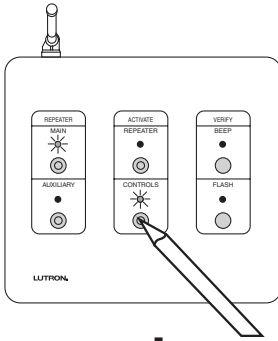

The green ACTIVATE CONTROLS LED on **ALL** Repeaters will turn OFF. The MAIN or AUXILIARY LED will remain on.

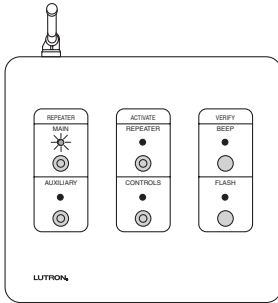

Step 4 Verify that Sivoia™ Control has been activated

Press and hold the FLASH button on any Repeater until the green FLASH LED turns ON (approximately 3 seconds).

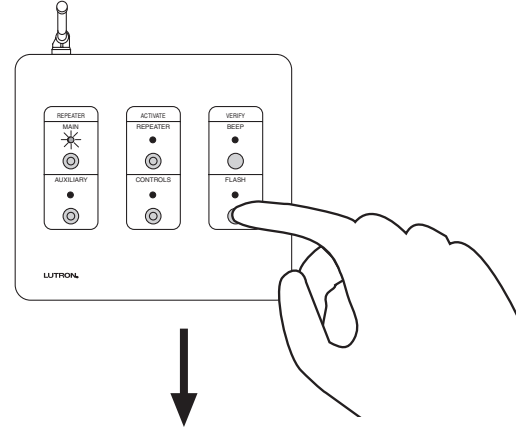

Green FLASH LED on all Repeaters will turn ON.

Sivoia™ Control, if activated, will alternately flash its top and bottom LEDs. All Dimmers and Master Controls already activated in the system will also flash.

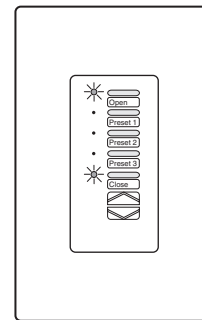

Exit FLASH mode by pressing and holding the FLASH button again, or press a button on any activated control.



If a Sivoia™ Control fails to respond to FLASH mode, consult the Troubleshooting Guide on page 20.

Adding a RadioRA® Sivoia™ Control

Changing Preset Levels

Presets 1, 2, and 3 come preprogrammed to 75% open, 50% open, and 25% open respectively. To change them, complete the following steps.

Step 1 Begin programming presets

On the RadioRA® Sivoia™ Control, use the raise or lower buttons to adjust your window treatment(s) to the desired position.

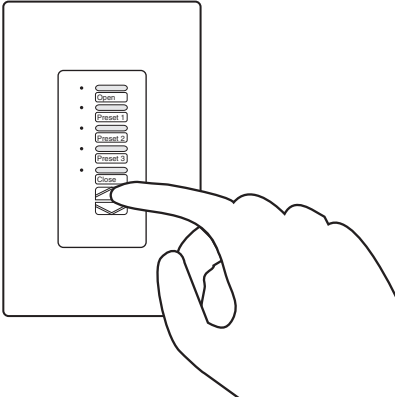

Step 2 Set preset position

Press and hold the preset button you wish to reprogram (approximately 3 seconds).

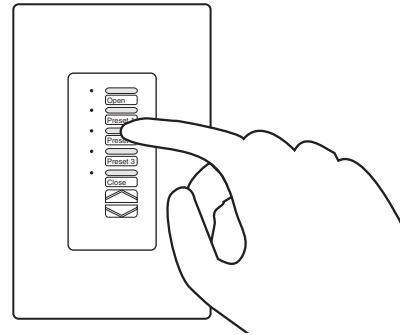

The corresponding LED will flash twice, then turn ON. The preset is now programmed to the current window treatment setting.

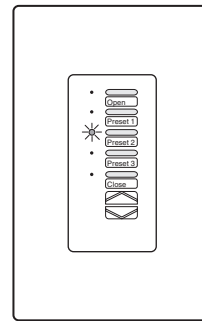

- Repeat Steps 1 and 2 for any other preset buttons you wish to change.



If the preset fails to change, consult the Troubleshooting Guide on page 20.

Master Control Button Programming

Assigning a Sivoia™ Control to Master Control Buttons

Step 1 Begin assigning Sivoia™ Controls to ROOM/SCENE buttons

Simultaneously press and hold the 2nd and 4th buttons in the right most column of the Master Control until the upper right LED begins to flash (approximately 3 seconds).

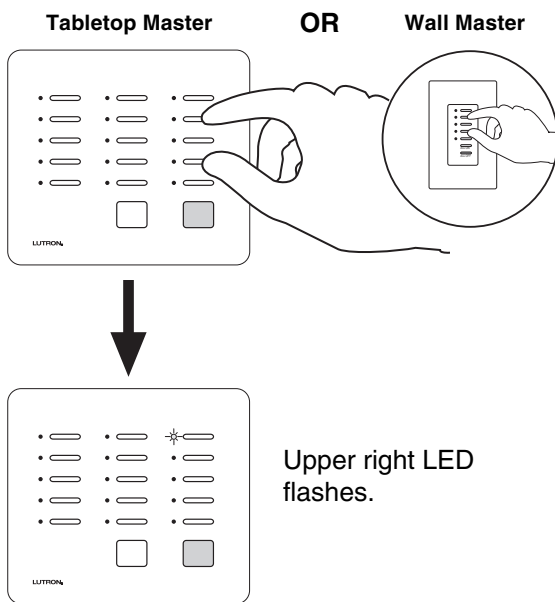

Step 2 Select a button

Press and release the button that you want to program. Its LED will begin to flash.

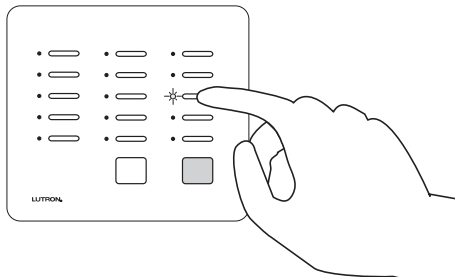

Note: All devices **assigned** to that button will turn ON to: Dimmers 100% light level, Switches ON, GRAFIK RA™ / GRAFIK Eye® Control Units to scene 1, and Sivoia™ Controls to Open. All devices **not assigned** to that button will turn OFF (Sivoia™ Controls will Close).

Step 3 Assign a Sivoia™ Control to the button

Assign Sivoia™ Controls to the Master Control button by pressing the Open button. The window treatment(s) will open.

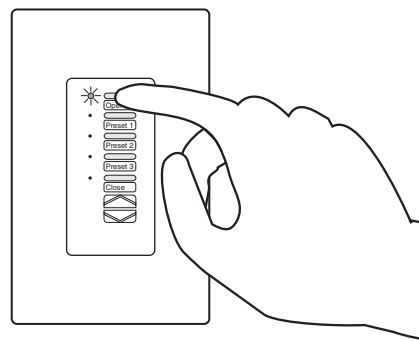

Notes:

- Multiple Dimmers, Switches, GRAFIK RA™ / GRAFIK Eye® Control Units, or Sivoia™ Controls can be assigned to a single button.
- Controls must be assigned to a Master Control button while its LED is flashing.



If you assign the wrong Sivoia™ Control to a Master Control button, press the Close button on the Sivoia™ Control to unassign it. The window treatment(s) will close.

Master Control Button Programming

Step 4 Select next button

To assign a Sivoia™ Control to another Master Control button, press and release that button. Its LED will begin to flash.

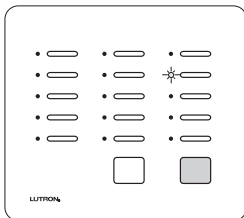
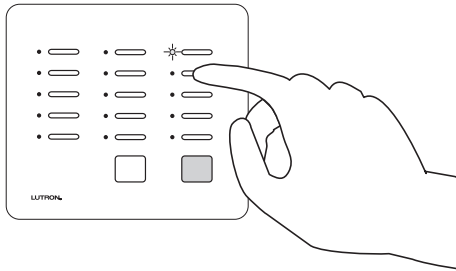

Perform Step 3 for this newly selected button.

- Proceed to Step 5 when all buttons on this Master Control have been programmed.

Step 5 Complete assigning Sivoia™ Controls

Simultaneously press and hold the 2nd and 4th buttons in the right most column of the Master Control until all LEDs begin to flutter (approximately 3 seconds).

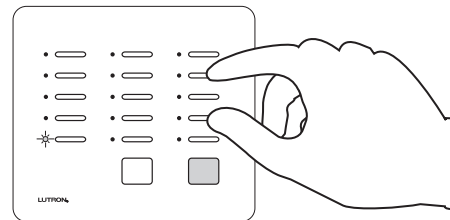

- Repeat Steps 1 through 5 for each Master Control you would like to control the Sivoia™ motorized window treatment(s).
- Pressing a ROOM/SCENE button with newly assigned Sivoia™ Controls will cause those window treatment(s) to open.

Master Control Button Programming

Setting Sivoia™ Presets for Master Control Buttons

Step 1 Begin setting presets

Simultaneously press the 1st and 5th buttons in the right most column of the Master Control until the upper right LED begins to blink (approximately 3 seconds).

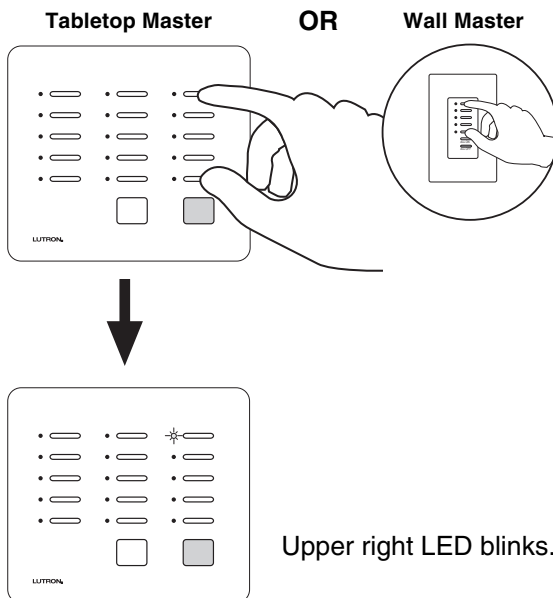

Step 2 Select a button

Press and release the button that you want to program. Its LED will begin to blink.

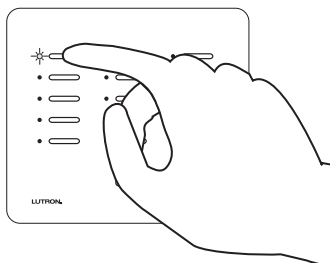

Note: All devices **newly assigned** to that button will turn ON to: Dimmers 50% light level for SCENE buttons, Dimmers 100% light level for ROOM buttons, Switches ON, GRAFIK RA™ / GRAFIK Eye® Control Units to scene 1, and Sivoia™ Controls to Open. All devices **not assigned** to that button will turn OFF (Sivoia™ Controls will Close).

Step 3 Select desired Sivoia™ preset

Press the desired preset button on the **assigned** Sivoia™ Control. The corresponding LED will turn ON, indicating the preset was set to the Master Control button.

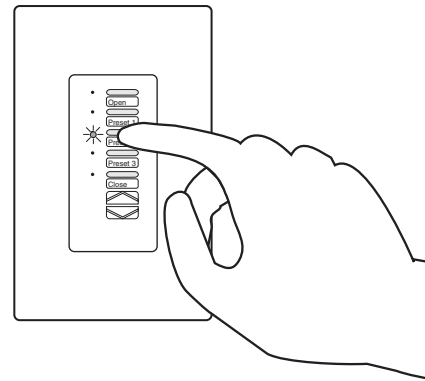

Notes:

- The raise and lower buttons have special functionality in this mode. Refer to Section 4 - Setting a SCENE button as a Stop button (page 14) for more information.
- Window treatment(s) assigned to a Master Control ROOM button cannot be set to the Close button.

Master Control Button Programming

Step 4 Select next button

To set the preset level for another Master Control button, press and release that button. Its LEDs will begin to blink.

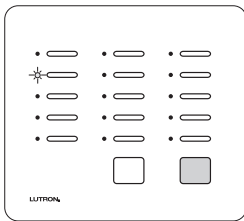
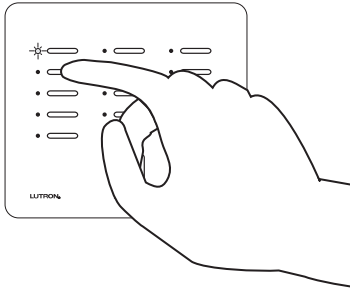

Perform Step 3 for this newly selected button.

- Proceed to Step 5 when all buttons on this Master Control have been programmed.

Step 5 Complete setting shade presets

Simultaneously press the 1st and 5th buttons in the right most column until all LEDs begin to flutter (approximately 3 seconds).

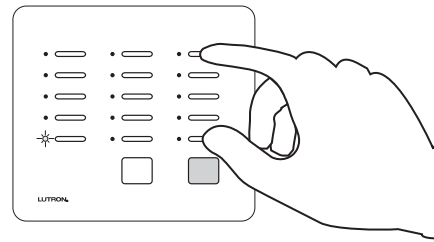

- Repeat Steps 1 through 5 for each Master Control that has buttons with Sivoia™ controls assigned.

Additional Features

Setting a SCENE button as a Stop button

This feature allows you to stop moving window treatments from a Master Control.

Step 1 Assign Sivoia™ Control to Stop Button

Assign the Sivoia™ Control to the SCENE button that will be the Stop button. See Section 3 - Assigning a Sivoia™ Control to Master Control Buttons (page 10). ROOM buttons cannot be Stop buttons.

Step 2 Begin setting Stop button

Simultaneously press the 1st and 5th buttons in the right most column of the Master Control until the upper right LED begins to blink (approximately 3 seconds).

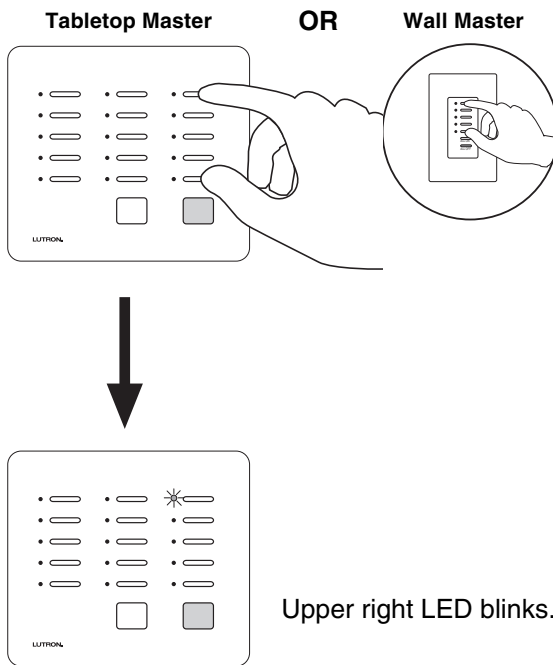

Step 3 Select Stop button

Press and release the button that you want to program. Its LED will begin to blink.

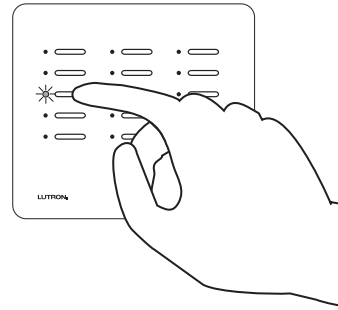

Additional Features

Step 4 Set button as Stop

Press and hold both the raise and lower buttons together on the Sivoia™ Control for approximately 3 seconds.

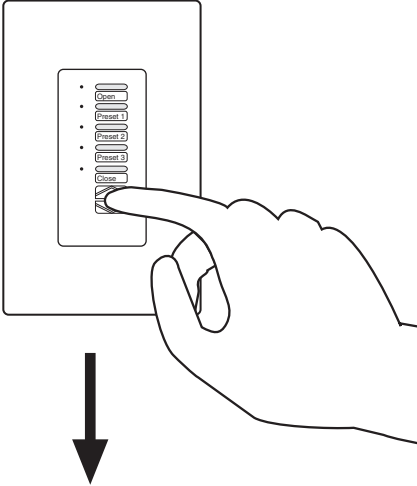

LEDs on the Sivoia™ Control will begin to cycle down indicating that this Master Control button is set to Stop the window treatment(s).

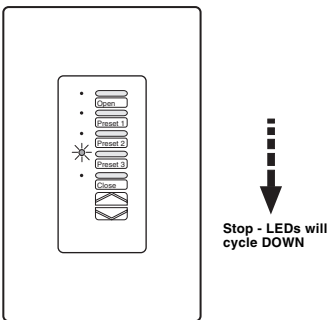

Step 5 Select next button

To set another Master Control button as a Stop button, press and release that button. Its LED will begin to flash.

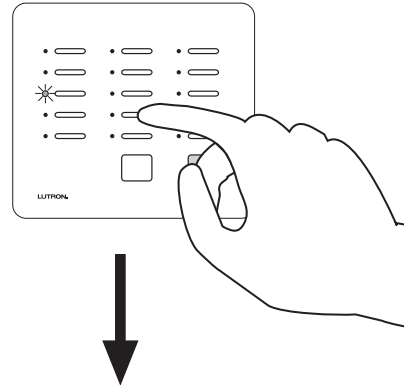

Perform Step 4 for this newly selected button.

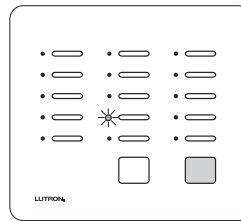

- Proceed to Step 6 when all buttons on this Master Control have been programmed.

Step 6 Complete setting Stop buttons

Simultaneously press and hold the 1st and 5th buttons in the right most column until all LEDs begin to flutter (approximately 3 seconds).

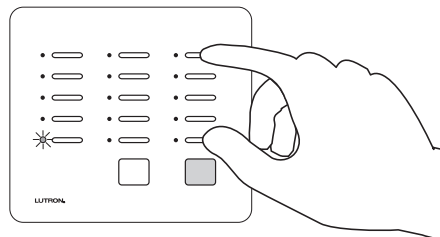

Additional Features

Adding a RadioRA® Sivoia™ Control to an ALL ON or ALL OFF button

Step 1 Begin the ALL ON or ALL OFF button programming

On the Master Control you want to program, simultaneously press and hold the 2nd and 4th buttons in the right most column until the upper right LED begins to flash (approximately 3 seconds).

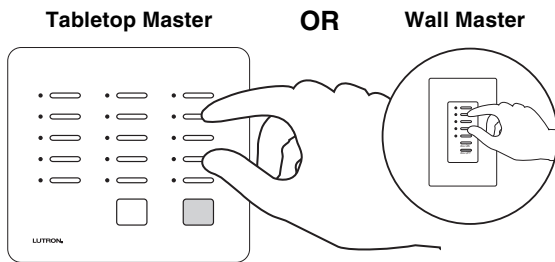

Upper right LED flashes.

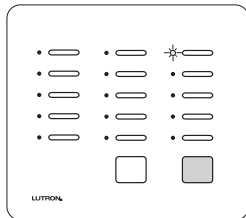

Step 2 Press the ALL ON or ALL OFF button

Press the ALL ON or ALL OFF button on the Master Control you are programming.

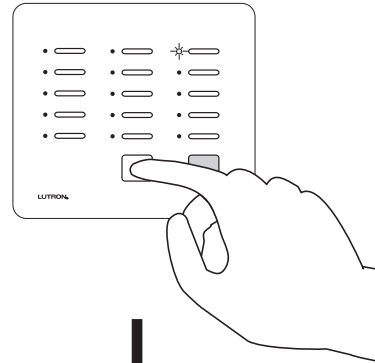

The LEDs in all columns will simultaneously cycle from bottom to top for ALL ON or from top to bottom for ALL OFF.

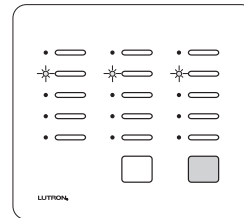

ALL ON - LEDs
cycle UP

ALL OFF - LEDs
cycle DOWN



All **assigned** RadioRA® Dimmers, Switches, GRAFIK RA™ / GRAFIK Eye® Control Units, and Sivoia™ Controls will turn ON. All **unassigned** controls will be OFF.

Additional Features

Step 3 Add the RadioRA® Sivoia™ Control to the button

Press the Open button on the Sivoia™ Control you want to add.

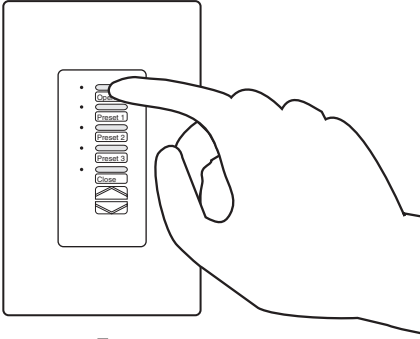

The corresponding LED will turn ON, and the window treatment(s) will open, indicating the Sivoia™ Control was added to the Master Control button.

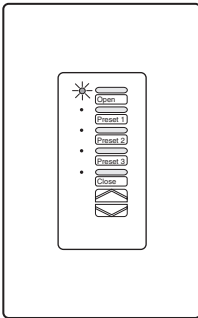

If you add the wrong RadioRA® Sivoia™ Control, press the Close button to remove it from that Master Control button. The window treatment(s) will close, indicating the Sivoia™ Control was removed.

Step 4 Complete the ALL ON or ALL OFF button programming

Simultaneously press and hold the 2nd and 4th buttons in the right most column until all LEDs begin to flutter (approximately 3 seconds).

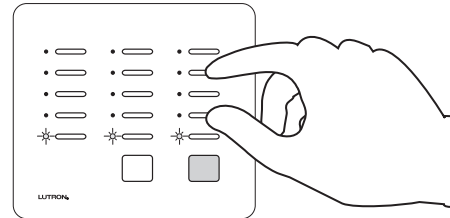

- Repeat Steps 1 through 4 to add a RadioRA® Sivoia™ Control to the ALL ON or ALL OFF button to any additional Master Controls.

Changing Default Settings

Changing the default settings will allow you to choose whether the window treatments will remain unchanged when a SCENE is being raised, lowered, or toggled to OFF. Local presets may also be locked, so that they are not accidentally changed.

Step 1 Enter Default Settings Mode

Simultaneously press and hold the Open, Raise and Lower buttons until the top LED begins to flash (approximately 3 seconds).

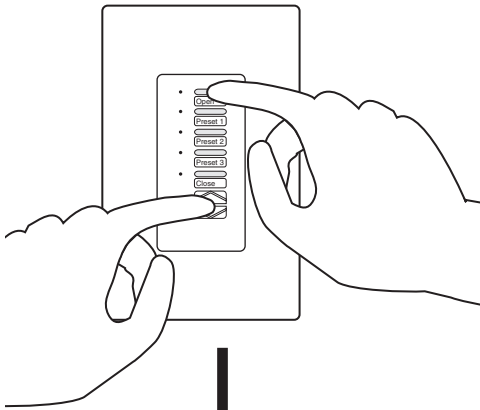

Open LED flashes.

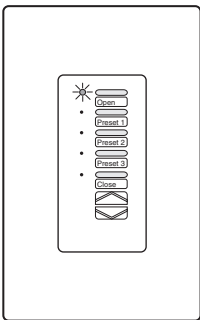

Step 2 Change Settings

Press and hold a button to change the default settings.

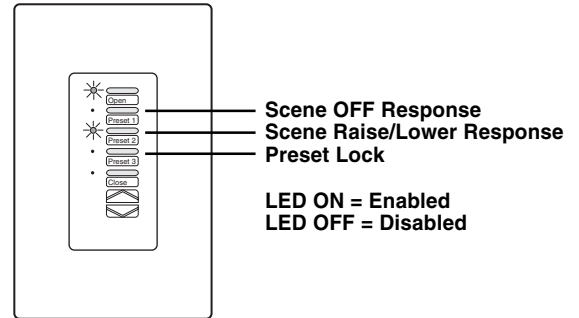

Scene OFF Response (Preset 1 button) - If Scene OFF Response is enabled, the window treatment(s) will Close when a Scene button is toggled OFF from a RadioRA® Master Control. If disabled, the window treatment(s) will not move. By default, Scene OFF Response is disabled.

Scene Raise/Lower Response (Preset 2 button) - If Scene Raise/Lower is enabled, the window treatment(s) will raise or lower when a Master Control Raise/Lower button that is assigned to the Sivoia™ Control is pressed. If disabled, the window treatment(s) will not move. By default, Scene Raise/Lower Response is enabled.

Preset Lock (Preset 3 button) - If Preset Lock is enabled, you will not be able to change the window treatment(s) preset level on the Sivoia™ Control. If disabled, you will be able to change the preset levels as described on page 9. By default, Presets are not locked.

Step 3 Exit Default Settings Mode

On the Sivoia™ Control, press and hold the Open, Raise, and Lower buttons until the LEDs flutter (approximately 3 seconds).

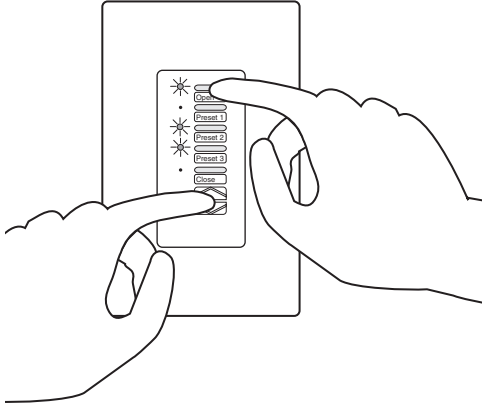

Troubleshooting Guide

Proper operation of the RadioRA® Wireless Central Home Lighting Control System is based upon a complex series of radio frequency (RF) communications between system components. As such, it is highly dependent upon proper system installation and programming of controls.

If you experience difficulties programming or operating your RadioRA® system, please refer to this guide. Many symptoms of common system activation or programming errors are contained in this Troubleshooting Guide. If you are having a problem with your system not described here, or if you have any questions, call the **Lutron Technical Support Center** at 1-800-523-9466.

	Symptom	Possible Cause	Remedy
I	ACTIVATE CONTROLS LED on MAIN or AUXILIARY Repeater turns ON and then back OFF when attempting to go into ACTIVATE CONTROLS mode.	Your system has encountered a neighboring system within RF communication range also in ACTIVATE CONTROLS mode.	Discontinue activating your RadioRA® system until activation of the neighboring system is complete.
II	After activating a Sivoia™ Control, the Control changes state, but doesn't flash its LEDs to indicate it has been activated.	Sivoia™ Control may be out of RF communication range of nearest system Repeater.	Verify whether the Sivoia™ Control is in range of a Repeater by placing the system in BEEP mode. (Refer to the Troubleshooting Section in the RadioRA® Setup Guide P/N 044-001.)
		System is not in ACTIVATE CONTROLS mode.	Place system in ACTIVATE CONTROLS mode (see page 7).
III	The Sivoia™ Control appears not to be working at all and the LEDs are OFF.	No power available to the Sivoia™ Control.	Check that Sivoia™ MDU has power.
IV	The Sivoia™ Control does not affect the window treatment(s) but the LEDs respond to button presses.	Sivoia™ communication link was not properly wired.	Rewire the Sivoia™ Control to the Motor Drive Unit (see page 5).
V	The Sivoia™ Control appears to function normally, but fails to respond to RadioRA® Master Control button presses.	Sivoia™ Control may be out of RF communication range of nearest system Repeater.	Verify whether the Sivoia™ Control is in range of a Repeater by placing the system in BEEP mode. (Refer to the Troubleshooting Section in the RadioRA® Setup Guide P/N 044-001.)
		The Sivoia™ Control has been incorrectly activated.	Verify that each control has been activated correctly by placing the system into FLASH mode (see page 9).
		RadioRA® Master Control was not programmed properly.	Reprogram Master Control (see page 10).
		The Sivoia™ Control or RadioRA® Master Control may be out of communication range of the nearest system Repeater.	Verify whether the controls are in range of a system Repeater by placing the system in BEEP mode. Refer to the RadioRA® Setup Guide, Lutron P/N 044-001.
		A noise source (such as a motor or computer) is interfering with the RF communications.	Move the noise source away from the affected control (or vice versa if the control is a Tabletop Master Control). If it is not possible to move the noise source, move a system Repeater closer to the affected control.

Troubleshooting Guide

	Symptom	Possible Cause	Remedy
VI	The Sivoia™ Control does not respond when the Raise or Lower button on a RadioRA® Master Control is pressed.	The Raise and Lower buttons are not set to affect the ROOM/ SCENE button you wish to Raise/ Lower.	Double tap the ROOM/SCENE button that you wish to control with the Raise and Lower buttons.
		The Sivoia™ Control is set to not respond to SCENE Raise/Lower from a RadioRA® Master Control.	Change the default setting for Scene Raise/Lower Response (see page 18).
VII	The Sivoia™ Control does not Close when a SCENE button on a RadioRA® Master Control is toggled OFF.	The Sivoia™ Control is set to not respond to SCENE OFF commands from a RadioRA® Master Control.	Change the default setting for Scene OFF Response (see page 18).

Returning to Default Factory Settings

RadioRA® Sivoia™ Control

 Returning a Sivoia™ Control to Default Factory Settings will permanently delete all current programming information. **Do not do this unless you are sure that it is necessary.** For more information call the *Lutron Technical Support Center at 1-800-523-9466.*

Step 1 Begin returning to Default Factory Settings

 Ensure that the ACTIVATE REPEATER LED and ACTIVATE CONTROLS LED on any Repeater is **NOT ON** before proceeding. If either LED is ON, press the corresponding button until its LED turns OFF (approximately 3 seconds).

Press and hold the 1st, 3rd and 5th buttons until the corresponding LEDs begin to flash (approximately 3 seconds).

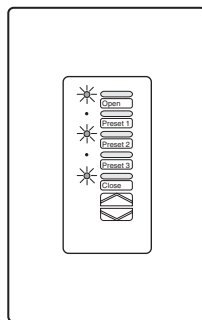
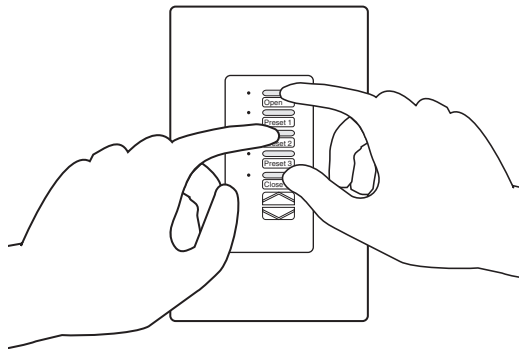

LEDs will flash for only 3 seconds.

Step 2 Complete returning to Default Factory Settings

While the 1st, 3rd, and 5th LED are flashing, press and hold the 2nd and 4th buttons in the right most column until all the LEDs flash (approximately 3 seconds).

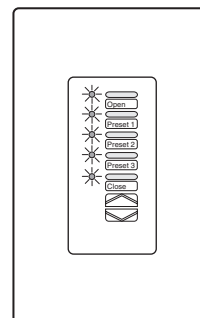
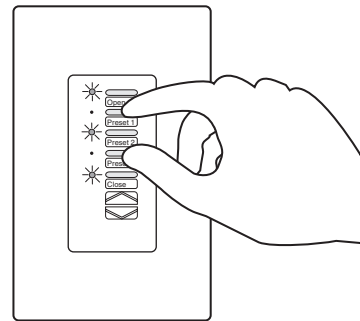

All LEDs flash.

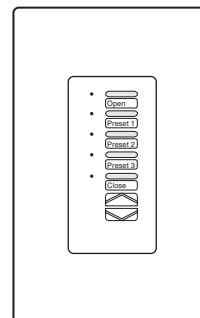

All LEDs will turn OFF, indicating that the Sivoia™ Control has been returned to Default Factory Settings.

Notes

Limited Warranty

Lutron will, at its option, repair or replace any unit that is defective in materials or manufacture within one year after purchase. For warranty service, return unit to place of purchase or mail to Lutron Electronics Co., Inc. at 7200 Suter Rd., Coopersburg, PA 18036-1299, postage pre-paid.

THIS WARRANTY IS IN LIEU OF ALL OTHER EXPRESS WARRANTIES, AND THE IMPLIED WARRANTY OF MERCHANTABILITY IS LIMITED TO ONE YEAR FROM PURCHASE. THIS WARRANTY DOES NOT COVER THE COST OF INSTALLATION, REMOVAL OR REINSTALLATION, OR DAMAGE RESULTING FROM MISUSE, ABUSE, OR DAMAGE FROM IMPROPER WIRING OR INSTALLATION. THIS WARRANTY DOES NOT COVER INCIDENTAL OR CONSEQUENTIAL DAMAGES. LUTRON'S LIABILITY ON ANY CLAIM FOR DAMAGES ARISING OUT OF OR IN CONNECTION WITH THE MANUFACTURE, SALE, INSTALLATION, DELIVERY, OR USE OF THE UNIT SHALL NEVER EXCEED THE PURCHASE PRICE OF THE UNIT.

This warranty gives you specific legal rights, and you may have other rights which vary from state to state. Some states do not allow the exclusion or limitation of incidental or consequential damages, or limitation on how long an implied warranty may last, so the above limitations may not apply to you.

This product may be covered under one or more of the following U.S. patents: 4,835,343; 4,954,768; 5,248,919; 5,399,940; 5,637,930; 5,736,965; 5,798,581; 5,838,226; 5,848,054; 5,905,442; 5,982,103; DES 353,798; DES 378,814; DES 389,461; DES 389,805; DES 395,037; DES 404,013; DES 422,969; DES 428,855; DES 436,579; DES 439,220 and corresponding foreign patents. U.S. and foreign patents pending. Lutron, Claro, GRAFIK Eye, and RadioRA are registered trademarks, and GRAFIK RA and Sivoia are trademarks of Lutron Electronics Co., Inc.

© 2002 Lutron Electronics Co., Inc.

Technical Assistance

If you have questions concerning the installation or operation of this product, call the **Lutron Technical Support Center**. Please provide exact model number when calling.

(800) 523-9466 (U.S.A., Canada, and the Caribbean)

Other countries call (610) 282-3800

Fax (610) 282-3090

Visit our web site at www.lutron.com

World Headquarters

Lutron Electronics Co., Inc.

7200 Suter Road

Coopersburg, PA 18036-1299 U.S.A.

TOLL FREE: (800) 523-9466 (U.S.A., Canada, and the Caribbean)

Tel: (610) 282-3800

Fax: (610) 282-3090

Lutron Electronics Co., Inc., reserves the right to make improvements or changes in its products without prior notice. Although every attempt is made to ensure that this information is accurate and up to date, please check with Lutron to confirm product availability, latest specifications and suitability for your application.