

English

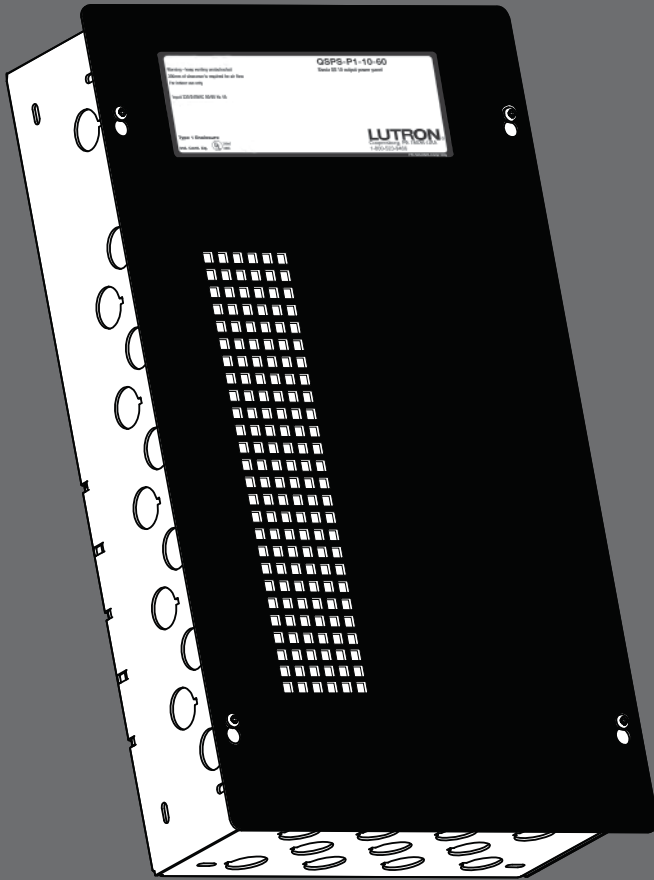

QS Smart Power Supply Panel

Installation
Instructions

QSPS-P1-10-60

 **LUTRON®**

QSPS-P1-10-60

Input: 120 V \sim 60 Hz 8 A (35% duty cycle)

Output: 24 V \equiv 2.5 A per output (35% duty cycle)
or

Input: 120 V \sim 60 Hz 4.6 A continuous

Output: 24 V \equiv 1 A continuous per output

Installation Instructions (Save these instructions)

Read and Follow all instructions.

Tools Required:

Wire Cutter/Stripper

Power Drill

Small Flat-Head Screwdriver

#2 Phillips Screwdriver

NOTE: Mounting hardware is not included due to the wide variety of wall materials. Customer should determine the appropriate mounting hardware for their specific needs.

Box Contents:

QSPS-P1-10-60

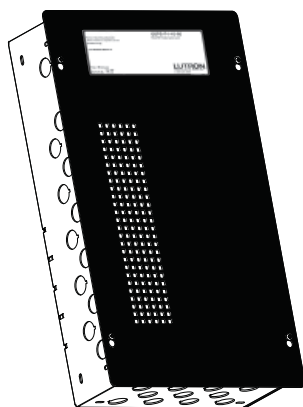

1 Important Notes

1.1

1. All wiring must be in accordance with national and local electrical codes.
2. Note: Secondary wiring must be of type CL2, CL2P, CL2R, CL2X or other cable with equivalent or better electrical, mechanical, and flammability ratings in accordance with local and national electric code.
3. QSPS-P1-10-60 must be installed by a qualified electrician.
4. Ambient operating temperature: 32 to 104 °F (0 to 40 °C), 0 - 90% humidity, non-condensing.
5. This product is intended for **indoor use only**.
No maintenance required.
6. Separate over current protection is required to be provided in accordance with Canadian Electrical Code, Part 1.
7. For continued protection against fire, replace only with the same type and rating of fuse.
(Littlefuse 5 X 20 mm fast-acting fuse 216 P series 2.5 A)

2.1

1. **Mount QSPS-P1-10-60** using one of the following methods (Mounting Hardware is not provided) Do not mount in any other orientation.
 - a. **Surface Mount** - Use the keyholes located on the back of the enclosure to fasten the QSPS-P1-10-60 to the wall. Use fasteners rated for a 50 lb (23 kg) load. See illustration of QSPS-P1-10-60.
 - b. **Recess Mount** - Install a 2 in x 4 in (50 mm x 100 mm) board between the studs as a bottom support. Fasten the QSPS-P1-10-60 to the right stud and bottom support inserting fasteners through the mounting holes provided.

NOTICE

The equipment is air-cooled. Mount in a location where the vented cover will not be blocked. A minimum of 1 ft (300 mm) is necessary.

WARNING

SHOCK HAZARD. Risk of serious injury or death. Locate and lock the supply breaker in the OFF position before wiring to the terminal blocks.

WARNING

SHOCK HAZARD. Risk of serious injury or death. Disconnect input power before servicing.

2. **Connect 120 V~ power wiring into the QSPS-P1-10-60.**

Remove one of the knockout tabs on the top left side of the enclosure near the input terminal blocks. Insert a strain relief into the knockout hole. Run the power wire through the strain relief (not included) to the input terminal blocks at the top left side of the enclosure. Tighten terminal blocks to 3.5 to 5 in-lbs (0.4 to 0.6 N•m).

Note: Maximum of 1 QSPS-P1-10-60 per 15 A Breaker.
 Maximum of 2 QSPS-P1-10-60 per 20 A Breaker.
 Maximum feed breaker size of 30 Amps.

Use only High-Magnetic breakers.

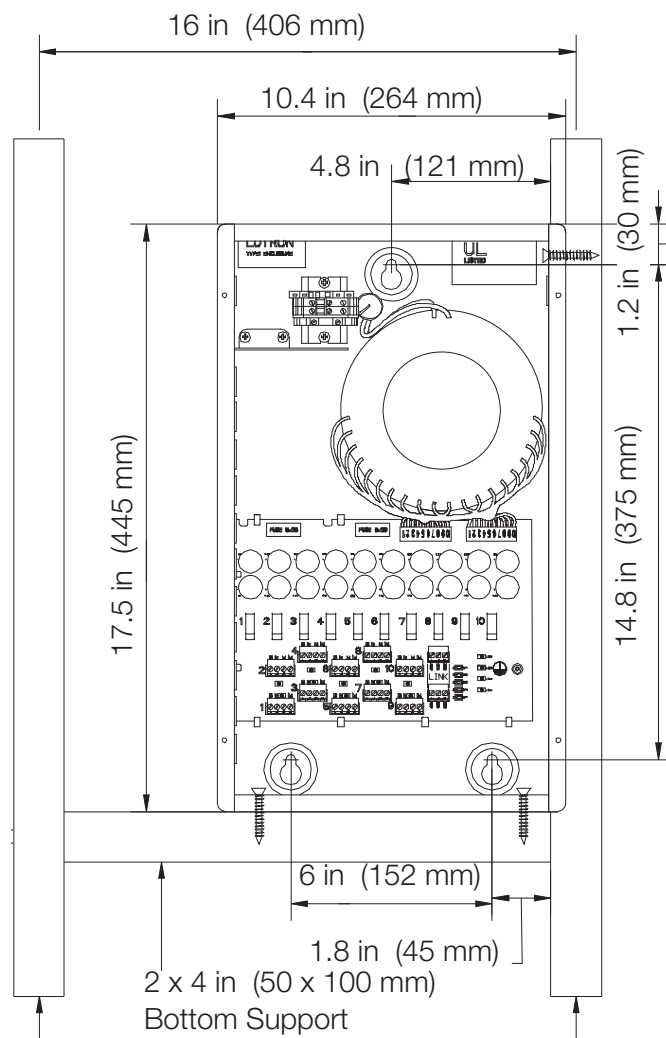

2.2 QSPS-P1-10-60 Parts identification

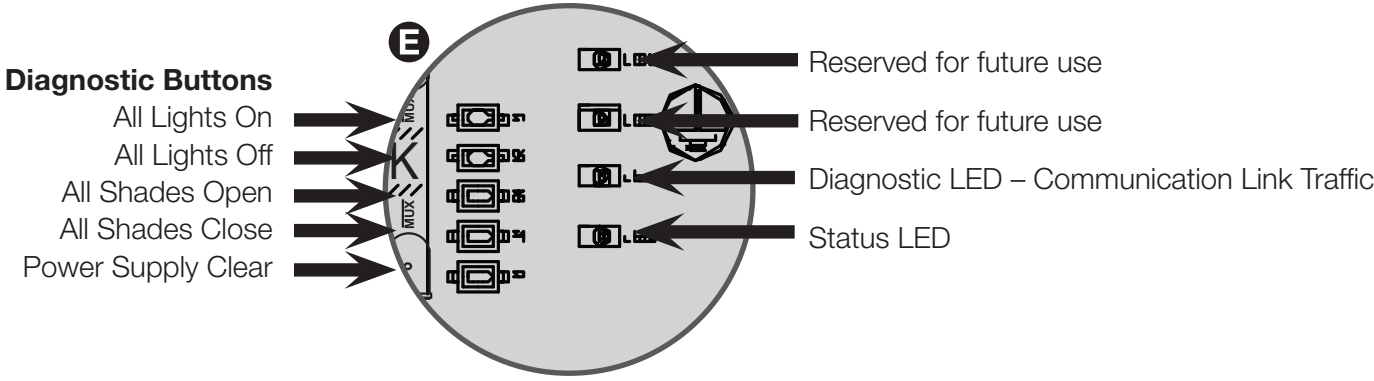
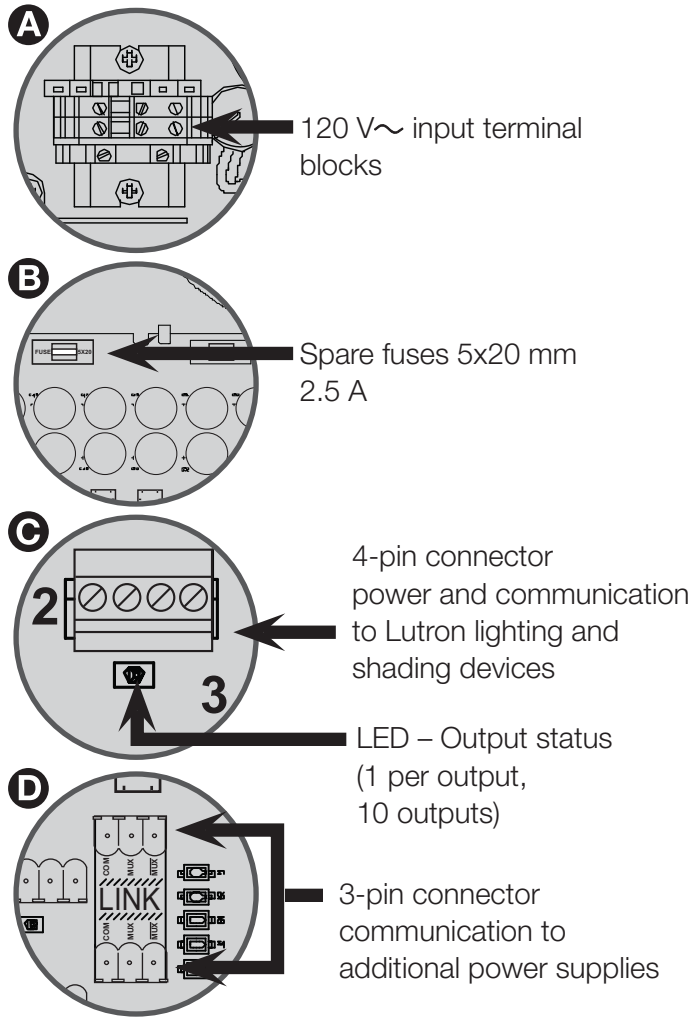
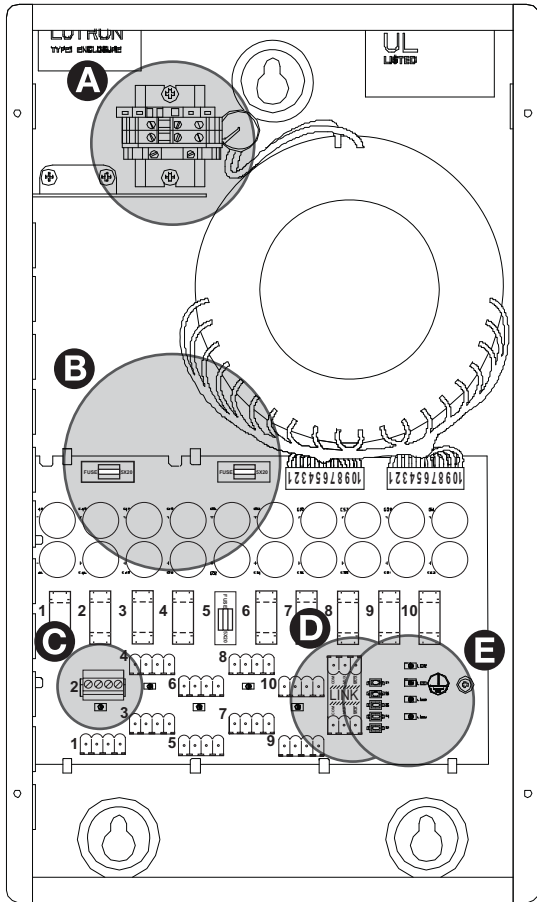

3.1 Link Rules

- Maximum of 100 devices (such as GRAFIK Eye® QS, seeTouch® QS keypad, smart panel power supply, or Sivoia® QS shade/drapery drive unit)
- Maximum of 100 zones (such as Sivoia QS shade/drapery drive unit, or a lighting zone on a GRAFIK Eye QS)
- Maximum 2000 ft (600 m) of cable connecting all smart panel power supplies
- Maximum 2000 ft (600 m) of cable to devices wired from each smart panel power supply
- Only use cable with at least one twisted/shielded pair for communications

3.2 Wire Length Chart

Use this chart to determine the number of shades and/or controls that can be run from one output on the Sivoia QS Smart Panel power supply, depending on the size of the shade. Then, verify the maximum cable length for the output configuration, based on the wire gauge that will be used.

Maximum devices per one output		Maximum distance per one output based on wire gauge			
Shades	+	Controls	12 AWG (4 mm ²) QSH-CBL-L-500 QSH-CBLP-L-500	16 AWG (1.5 mm ²) QSH-CBL-M-500 QSH-CBLP-M-500	18 AWG (1 mm ²) GRX-CBL-346S-500
None		Up to 50 power draw units	1250 ft (375 m)	500 ft (150 m)	250 ft (75 m)
None		Up to 25 power draw units	2000 ft (600 m)	1000 ft (300 m)	600 ft (175 m)
1 Sivoia QS shade or drapery		Up to 1 power draw unit	500 ft (150 m)	200 ft (60 m)	125 ft (35 m)
2 Sivoia QS roller 64, ≤ 30 ft ² (2.75 m ²) each			200 ft (60 m)	75 ft (20 m)	50 ft (15 m)
3 Sivoia QS roller 64, ≤ 20 ft ² (1.80 m ²) each					
2 Sivoia QS roller 100, ≤ 50 ft ² (4.6 m ²) each					

3.3 Example: Multiple shades per output

Sivoia QS roller 64, 25 sq ft (2.25 m²)

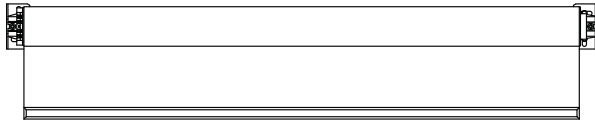

Sivoia QS roller 64, 25 sq ft (2.25 m²)

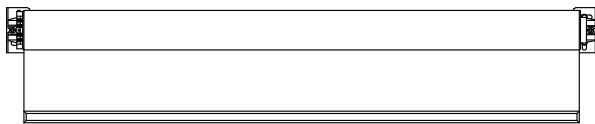

Up to 50 ft (15 m) of
18 AWG (1 mm²)
4-conductor twisted/
shielded wire



seeTouch® QS



Up to 250 ft (75 m) of
18 AWG (1 mm²)
4-conductor twisted/
shielded wire

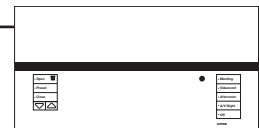
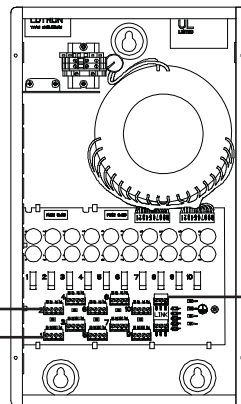

GRAFIK Eye® QS

3.4 Example: One shade per output

Sivoia QS roller 64, 25 sq ft (2.25 m²)

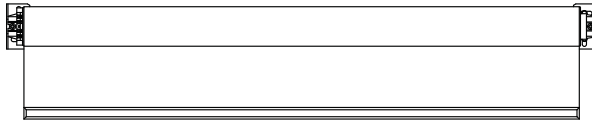

Sivoia QS roller 64, 25 sq ft (2.25 m²)

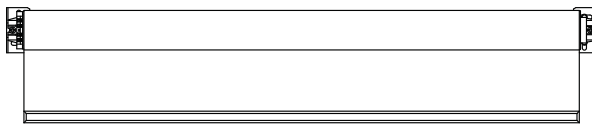

Up to 100 ft (30 m) of
18 AWG (1 mm²)
4-conductor
twisted/shielded wire

Up to 100 ft (30 m) of
18 AWG (1 mm²)
4-conductor twisted/
shielded wire



seeTouch® QS



Up to 250 ft (75 m) of
18 AWG (1 mm²)
4-conductor twisted/
shielded wire

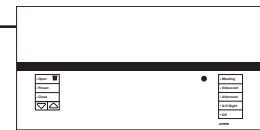
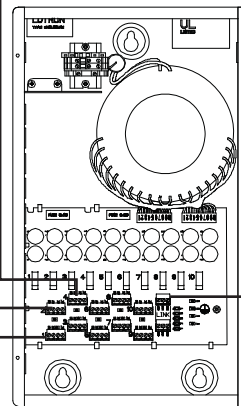

GRAFIK Eye® QS

4.1 Run low voltage wire into the QSPS-P1-60

Remove as many knockout tabs as necessary from the left side of the enclosure and insert strain reliefs.

Run the low-voltage communication wiring from the Lutron QS shade and lighting devices through the strain reliefs to the terminal blocks.

Strip insulation wire so that 0.25 in (7 mm) of bare wire is exposed. Make sure to tighten the screws tightly and that no insulation is inside of the terminal block.

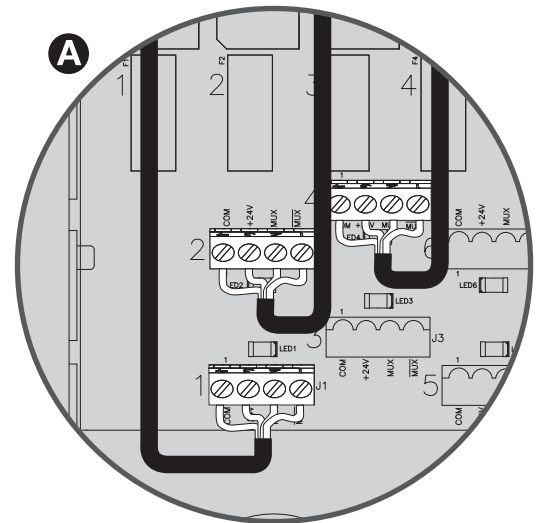
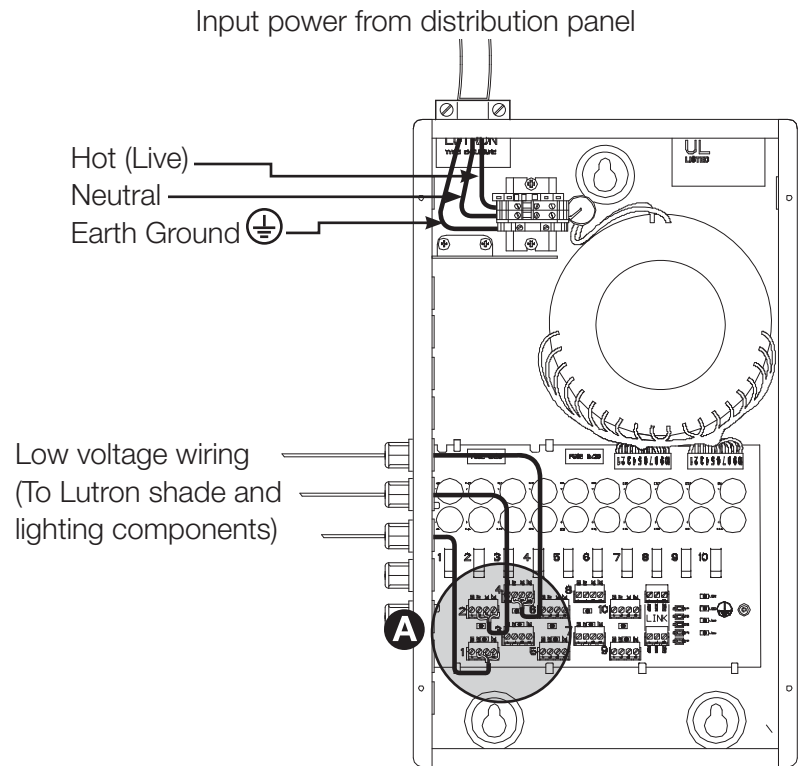

4.2 Connecting Multiple QSPS-P1-10-60 Panels

Use the two 3-pin terminal blocks when connecting multiple QSPS-P1-10-60 panels.

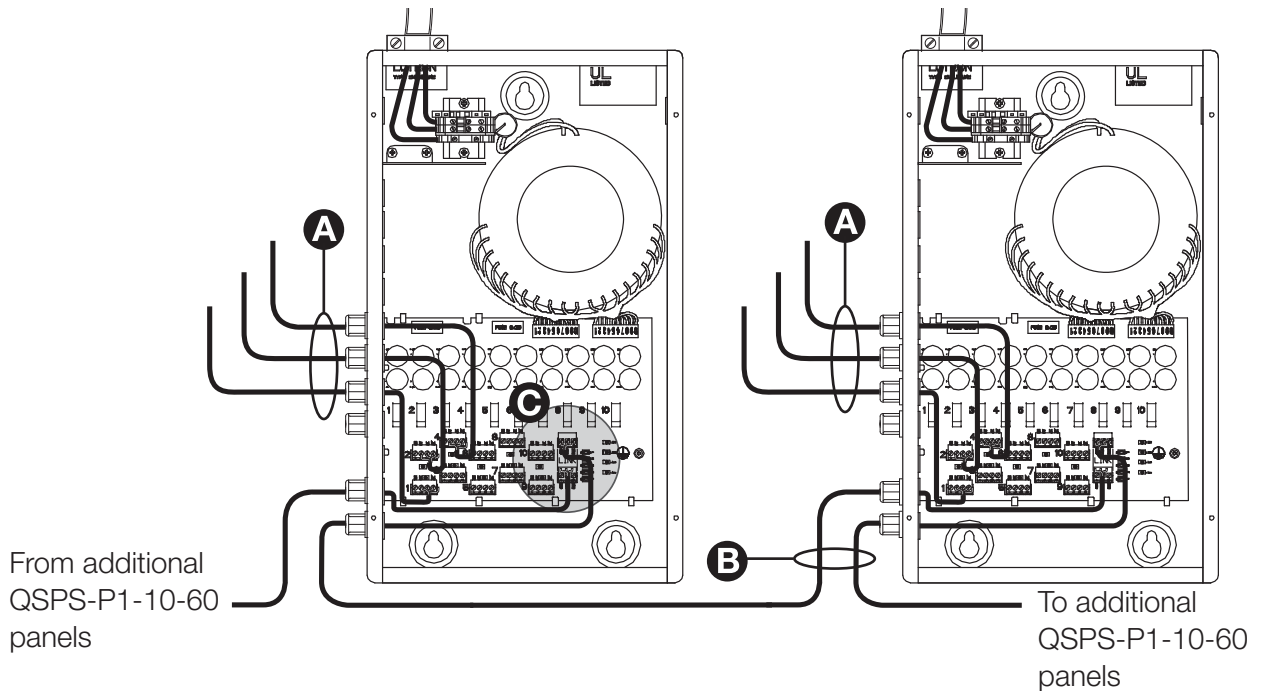

- A Device Link**
4 - conductor power and communications to devices.
Max 2000 ft (600 m) per QSPS-P1-10-60

- B Panel Link**
3 - conductor communications
Max 2000 ft (600 m) connecting all QSPS-P1-10-60 panels.

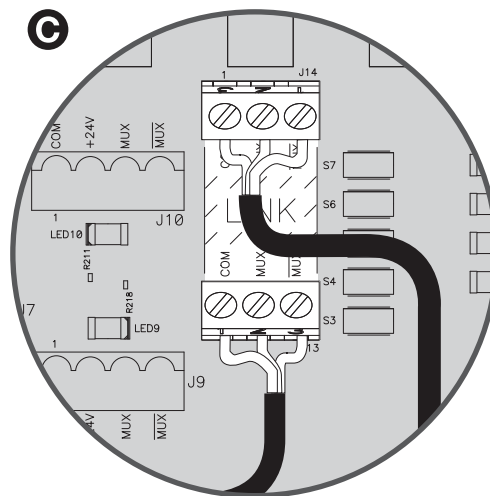

The QSPS-P1-10-60 provides built-in diagnostics to help troubleshoot and verify your installation.

5.1 Output status LEDs

Each output has a status LED to indicate if the output is properly powered. If an output becomes overloaded, its status LED will blink to indicate the fault condition. Press the “Power Supply Clear” button after the fault condition has been cleared and the LED will stop blinking.

A Output status LEDs

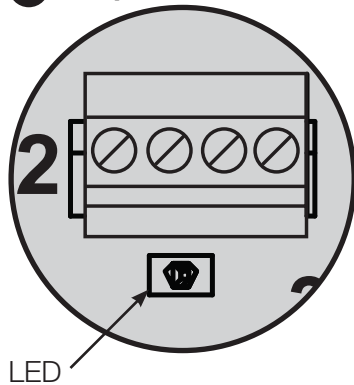

If an output status LED has turned off, the fuse will need to be replaced. The QSPS-P1-10-60 comes with two spare 5x20 mm 2.5 A fuses.

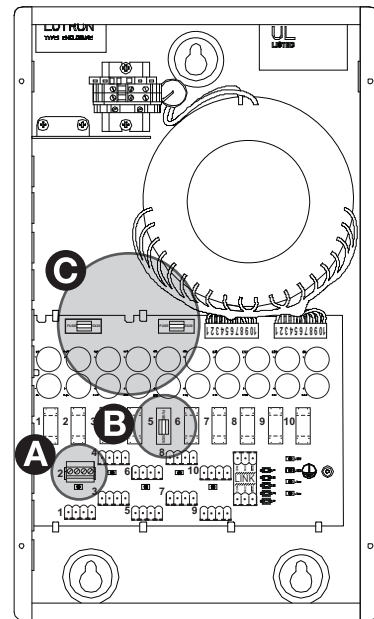

B Fuses

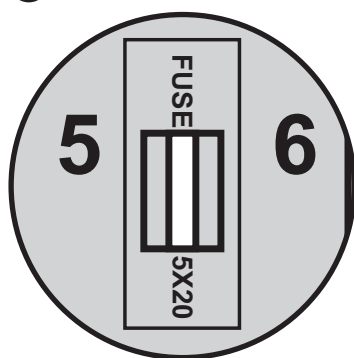

C Spare fuses

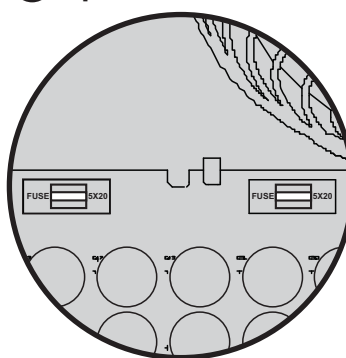

5.2 Communications Link LEDs

The QSPS-P1-10-60 has four diagnostic LEDs for the communications link.

A Diagnostic LEDs

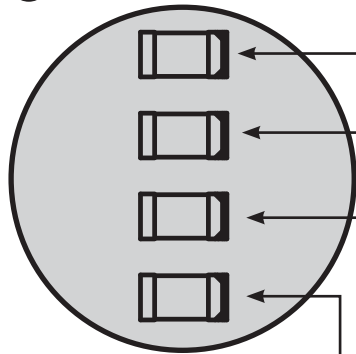

Reserved for future use

Reserved for future use

Link Traffic

This LED will blink green to indicate that devices are communicating.

Status LED

This LED indicates that the panel is operating properly. If this LED is off, check your wiring.

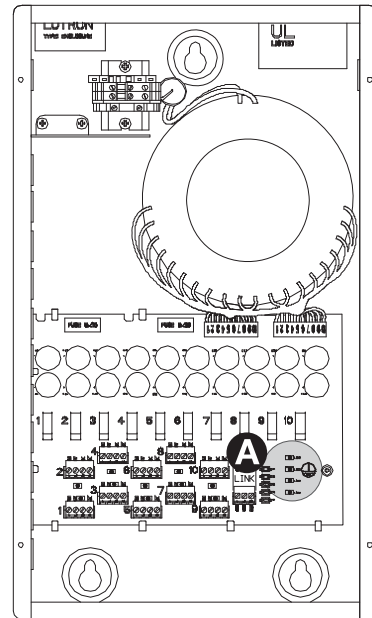

5.3 Verify Communications

To verify the communications of your system, tap, hold (5 seconds), tap, hold (5 seconds) the All Shades Open button. The QSPS-P1-10-60 is now trying to communicate with all other devices. All EDUs communicating on the link will wiggle and flash their green LED quickly. If you discover any EDUs that are not wiggling, verify that the EDU is powered and wired properly. Link Diagnostics Mode will automatically time out after 10 minutes.

To exit Link Diagnostics Mode, press and hold the All Shades Open button for 5 seconds.

Limited Warranty

SCOPE

This limited warranty (“Warranty”) covers the Lutron supplied (a) Sivoia® QS Shade System (“Sivoia® QS Shade System”), (b) Sivoia QED™ Shade System (“Sivoia QED™ Shade System”), (c) manual shade system and (d) alternating current or a/c shade system (each of the foregoing being a “System”). Customer acknowledges and agrees that use of the System constitutes acceptance of all terms and conditions of this Warranty.

LIMITED WARRANTY

Subject to the exclusions and restrictions described below, Lutron warrants that each System will be free from manufacturing defects from the date of shipment by Lutron for a period of (a) one year as to the wall controls, interfaces and system accessories of the Sivoia® QS Shade System (“External Sivoia® QS Components”) and (b) eight years as to the other Systems and the electronic drive unit, shade fabric and shade hardware of the Sivoia® QS Shade System. If any manufacturing defect exists in the External Sivoia® QS Components, so long as Customer promptly notifies Lutron of the defect within the one year warranty period and, if requested by Lutron, returns the defective part(s), Lutron will, at its option, either repair the defective part(s) or provide comparable replacement part(s). If any manufacturing defect exists in any of the components of a System other than the External Sivoia® QS Components, so long as Customer promptly notifies Lutron of the defect within the eight year warranty period and, if requested by Lutron, returns the defective part(s), Lutron will, at its option, either repair the defective part(s) or issue a credit to the Customer against the purchase price of comparable replacement part(s) purchased from Lutron as provided below:

Number of years from date of shipment	Percentage of cost of replacement parts credited by Lutron
Up to 5	100%
More than 5 but not more than 8	50%
More than 8	0%

Replacement parts for the System provided by Lutron or, at its sole discretion, an approved vendor may be new, used, repaired, reconditioned, and/or made by a different manufacturer.

EXCLUSIONS AND RESTRICTIONS

This Warranty will be void, and Lutron and its suppliers will have no responsibility under this Warranty, if Lutron or its representatives cannot access any components of the System to inspect, diagnose problems with or repair the System or any of its components as a result of concealment or inaccessibility of such components within a building structure.

This Warranty does not cover, and Lutron and its suppliers are not responsible for:

1. Damage, malfunction or inoperability diagnosed by Lutron or a Lutron approved third party as caused by normal wear and tear, abuse, misuse, incorrect installation, neglect, accident, interference or environmental factors, such as (a) use of incorrect line voltages fuses or circuit breakers; (b) failure to install, maintain and operate the System pursuant to the operating instructions provided by Lutron and the applicable provisions of the National Electrical Code and of the Safety Standards of Underwriter’s Laboratories; (c) use of incompatible devices or accessories; (d) improper or insufficient ventilation; (e) unauthorized repairs or adjustments or alterations; (f) vandalism; (g) an act of God, such as fire, lightning, flooding, tornado, earthquake, hurricane or other problems beyond Lutron’s control; or (h) direct exposure to corrosive materials.
2. On-site labor costs to diagnose issues with, and remove, repair, replace, adjust, reinstall and/or reprogram the System or any of its components.
3. Components and equipment external to the System, such as, non-Lutron lighting and automation systems; building wiring audio-visual equipment; and non-Lutron time clocks, photosensors and motion detectors.
4. The cost of repairing or replacing other property that is damaged when any System does not work properly, even if the damage was caused by the System.

THIS WARRANTY IS IN LIEU OF ALL OTHER EXPRESS WARRANTIES. ALL IMPLIED WARRANTIES, INCLUDING THE IMPLIED WARRANTIES OF MERCHANTABILITY AND OF FITNESS FOR A PARTICULAR PURPOSE, ARE LIMITED TO EIGHT YEARS FROM THE DATE OF SHIPMENT, EXCEPT THAT SUCH IMPLIED WARRANTIES ARE LIMITED TO ONE YEAR FROM THE DATE OF SHIPMENT AS TO THE EXTERNAL Sivoia QS COMPONENTS.

NO LUTRON AGENT, EMPLOYEE OR REPRESENTATIVE HAS ANY AUTHORITY TO BIND LUTRON TO ANY AFFIRMATION, REPRESENTATION OR WARRANTY CONCERNING THE SYSTEMS. UNLESS AN AFFIRMATION, REPRESENTATION OR WARRANTY MADE BY AN AGENT, EMPLOYEE OR REPRESENTATIVE IS SPECIFICALLY INCLUDED HEREIN, OR IN STANDARD PRINTED MATERIALS PROVIDED BY LUTRON, IT DOES NOT FORM A PART OF THE BASIS OF ANY BARGAIN BETWEEN LUTRON AND CUSTOMER AND WILL NOT IN ANY WAY BE ENFORCEABLE BY CUSTOMER.

IN NO EVENT WILL LUTRON OR ANY OTHER PARTY BE LIABLE FOR EXEMPLARY, CONSEQUENTIAL, INCIDENTAL OR SPECIAL DAMAGES (INCLUDING, BUT NOT LIMITED TO DAMAGES FOR PERSONAL INJURY, FAILURE TO MEET ANY DUTY, INCLUDING OF GOOD FAITH OR REASONABLE CARE, NEGLIGENCE, OR ANY OTHER LOSS WHATSOEVER), NOR FOR ANY REPAIR WORK UNDERTAKEN WITHOUT LUTRON'S PRIOR WRITTEN CONSENT ARISING OUT OF OR IN ANY WAY RELATED TO THE INSTALLATION, DEINSTALLATION, USE OF OR INABILITY TO USE THE SYSTEM OR OTHERWISE UNDER OR IN CONNECTION WITH ANY PROVISION OF THIS WARRANTY, EVEN IN THE EVENT OF THE FAULT, TORT (INCLUDING NEGLIGENCE), STRICT LIABILITY, BREACH OF CONTRACT OR BREACH OF WARRANTY OF LUTRON OR ANY OTHER PARTY, AND EVEN IF LUTRON OR SUCH OTHER PARTY WAS ADVISED OF THE POSSIBILITY OF SUCH DAMAGES.

NOTWITHSTANDING ANY DAMAGES THAT CUSTOMER MIGHT INCUR FOR ANY REASON WHATSOEVER (INCLUDING, WITHOUT LIMITATION, ALL DIRECT DAMAGES AND ALL DAMAGES LISTED ABOVE), THE ENTIRE LIABILITY OF LUTRON AND OF ALL OTHER PARTIES UNDER THIS WARRANTY ON ANY CLAIM FOR DAMAGES ARISING OUT OF OR IN CONNECTION WITH THE MANUFACTURE, SALE, INSTALLATION, DELIVERY, USE, REPAIR, OR REPLACEMENT OF THE SYSTEM, AND CUSTOMER'S SOLE REMEDY FOR THE FOREGOING, WILL BE LIMITED TO THE AMOUNT PAID BY CUSTOMER FOR THE SYSTEM. THE FOREGOING LIMITATIONS, EXCLUSIONS AND DISCLAIMERS WILL APPLY TO THE MAXIMUM EXTENT ALLOWED BY APPLICABLE LAW, EVEN IF ANY REMEDY FAILS ITS ESSENTIAL PURPOSE.

THIS WARRANTY GIVES YOU SPECIFIC LEGAL RIGHTS. YOU MAY ALSO HAVE OTHER RIGHTS WHICH VARY FROM STATE TO STATE. SOME STATES DO NOT ALLOW LIMITATIONS ON HOW LONG AN IMPLIED WARRANTY LASTS OR THE EXCLUSION OR LIMITATION OF INCIDENTAL OR CONSEQUENTIAL DAMAGES, SO THE ABOVE LIMITATIONS OR EXCLUSIONS MAY NOT APPLY TO YOU.

WARRANTY CLAIMS, TECHNICAL ASSISTANCE AND WARRANTY INFORMATION.

Contact the Lutron Technical Support Center at the numbers provided below or your local Lutron sales representative with questions concerning the installation or operation of the System or this Warranty, or to make a warranty claim. Please provide the exact model number when calling.

Lutron, the Sunburst logo, and Sivoia are registered trademarks, and Sivoia QS is a trademark of Lutron Electronics Co., Inc.

WORLD HEADQUARTERS

Lutron Electronics Co., Inc.
7200 Suter Road
Coopersburg, PA 18036
United States
Tel: +1.610.282.3800
Fax: +1.610.282.1243

ASIAN HEADQUARTERS

Lutron GL Ltd.
15 Hoe Chiang Road
#07-03 Tower Fifteen
Singapore 089316
Tel: +65.6220.4666
Fax: +65.6220.4333
lutronsea@lutron.com

EUROPEAN HEADQUARTERS

Lutron EA Ltd.
6 Sovereign Close
London, E1W 3JF
United Kingdom
Tel: +44.(0)20.7702.0657
Fax: +44.(0)20.7480.6899

CUSTOMER SERVICE/ ORDERING

UK +44.(0)20.7702.0657 –
09.00 - 18.00 GMT
USA +1.610.282.-3800 –
08.00 - 20.00 EST

CUSTOMER SERVICE /E-MAIL

shadinginfo@lutron.com

TECHNICAL SUPPORT & SERVICES

USA +1.610.282.3800 –
24 hours/7 days
UK +44.(0)20.7702.0657
09.00 - 18.00 GMT

INTERNET:

www.lutron.com

ADDITIONAL LUTRON SALES OFFICES:

Germany

Tel: +49.309.710.4590
Fax: +49.309.710.4591
FREEPHONE
00800.5887.6635

France

Lutron Ltc, S.A.R.L.-Paris
90 rue Villiers
92300 Levallois Perret,
France
Tel: +33.1.41.05.42.80
Fax: +33.1.41.05.01.80
FREEPHONE: 0800.90.12.18
lutronfrance@lutron.com

Spain-Madrid

Tel: +34.91.567.84.79
Fax: +34.91.567.84.78
FREEPHONE 0900.948.944

Spain-Barcelona

Tel: +34.93.496.57.42
Fax: +34.93.496.57.50
FREEPHONE 0900.948.944

Hong Kong

Tel: +852.2104.7733
Fax: +852.2104.7633

Beijing

Tel: +86.10.5877.1817
Fax: +86.10.5877.1816

Singapore

LUTRON GL Ltd. -
Singapore
15 Hoe Chiang Road
#7-03 Tower 15
Singapore 089316
Tel: +65.6220.4666
Fax: +65.6220.4333

Japan

Tel: +81.3.5575.8411
Fax: +81.3.5575.8420

www.lutron.com/shadingsolutions

USA and Canada (24 hrs/7days):
call: 800.523.9466

Other countries (8 a.m. – 8 p.m. ET)
call: +1.610.282.3800
fax: +1.610.282.3090

email: shadinginfo@lutron.com

©2012 LUTRON Electronics Co., Inc.
Printed in the U.S.A.
P/N 045-310 REV B

