

Sivoia® QS

shading solutions

Total Light Control



 **LUTRON**®

save
energy
with
Lutron™ 



TOTAL LIGHT CONTROL FROM LUTRON®

Sivoia QS is the next generation of shading technology from Lutron, and the ideal solution for total light control. The Sivoia QS shading product family includes roller blinds, curtain tracks, and skylight blinds. Its simplified wiring and common communication language allow for easy integration with Lutron lighting controls, including the GRAFIK Eye® QS. Control electric light and daylight at the touch of a button.

PRECISION CONTROL OF DAYLIGHT

- Control blinds and curtains with precision and elegance
- Blinds start, move, and stop in unison, maintaining perfect alignment with each other (within 3.17 mm)
- Minimal, symmetrical 19 mm light gaps ensure maximum window coverage

TOTAL LIGHT CONTROL

- Seamless integration with Lutron lighting controls for intuitive control of electric and daylight
- Adjustable light and blind zones for scene control

ULTRA-QUIET PERFORMANCE

- Manage daylight without disturbing the activity in a space
- Near-silent level operation rated at less than 44dBA at 1 m

EASY TO DESIGN, INSTALL, AND INTEGRATE

- Simplified low voltage wiring scheme
- Built-in diagnostics to verify system communications

SIMPLE OPERATION, BEAUTIFUL AESTHETICS

- Simple, intuitive control of blinds, curtains, and lights with seeTouch® QS keypads, IR remotes and RF controls through the QS Sensor Module (QSM)
- Wide variety of styles, colours, and metal finishes to complement your décor
- Backlit, engraved buttons for visible, intuitive control
- Preset buttons instantly recall a favourite light level or blind position

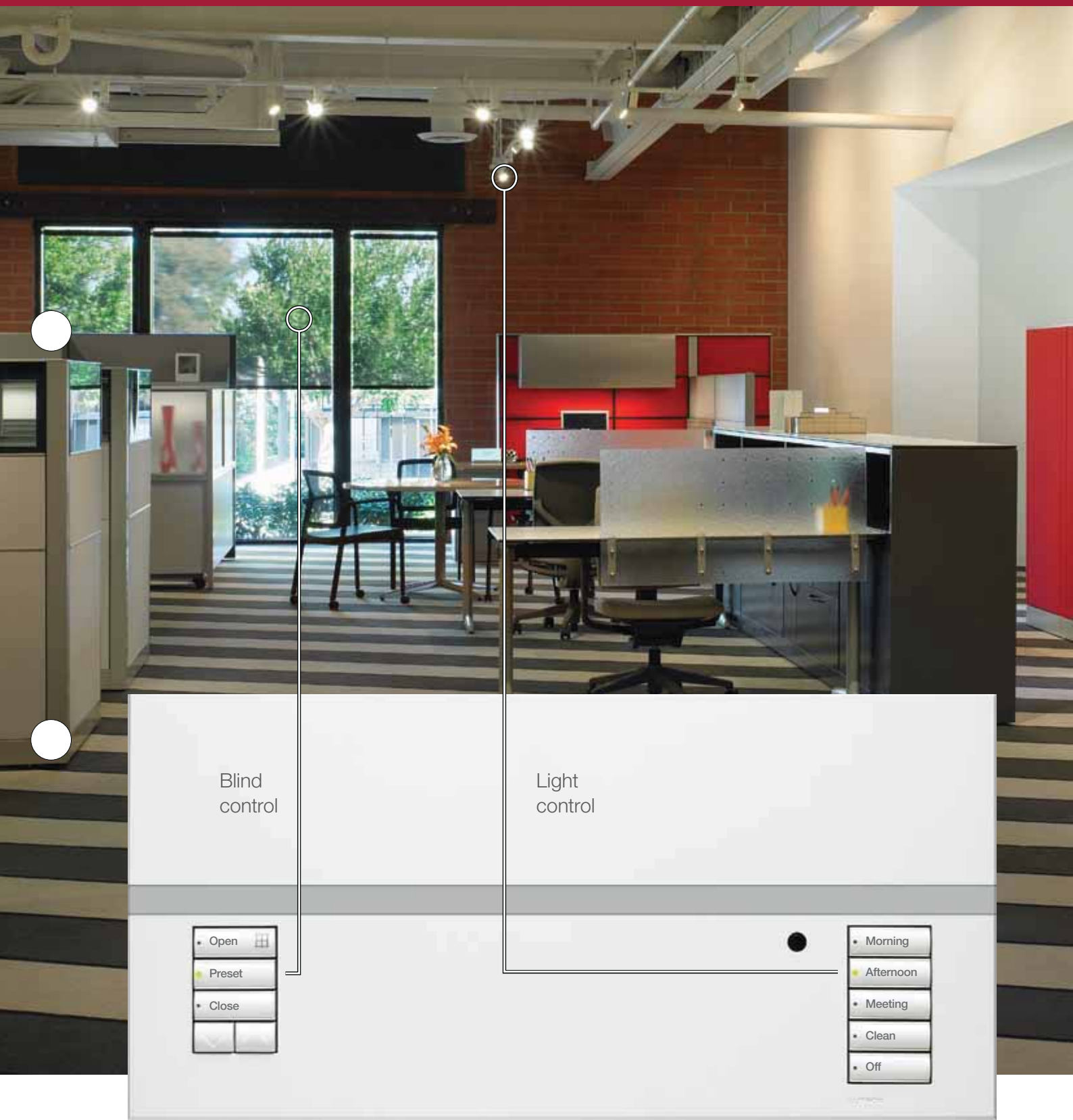

Blind control

Light control

- Open
- Preset
- Close

- Morning
- Afternoon
- Meeting
- Clean
- Off

Total light control at the touch of a button with the GRAFIK Eye® QS control (not actual size)

Sivoia QS shading solutions can scale from a standalone blind system to a total light control solution that integrates precision shading with lighting control.

STAND-ALONE BLIND CONTROL SYSTEM

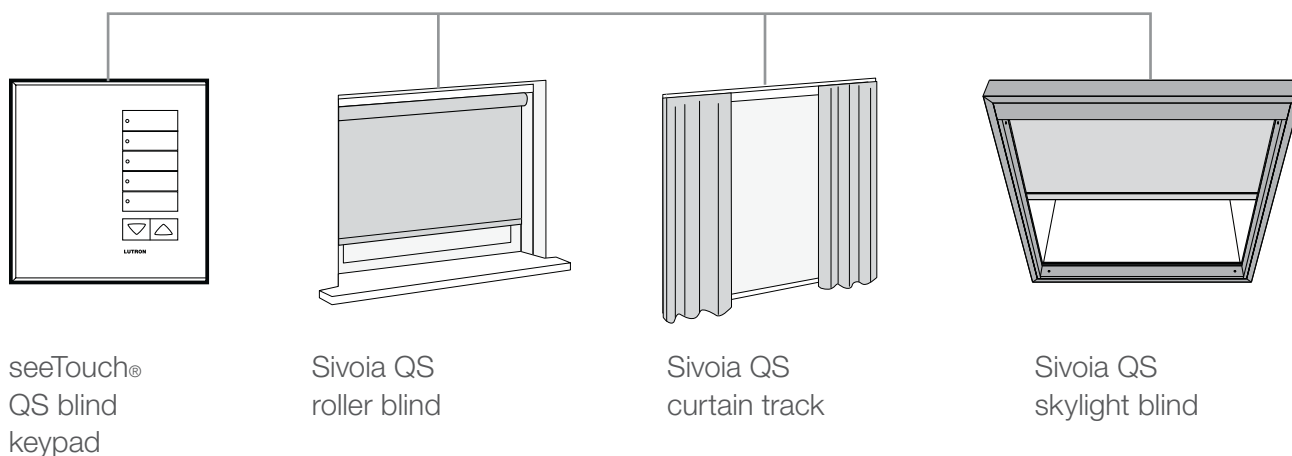

DAYLIGHT CONTROL

Daylight is a source of light that needs to be controlled to provide the right light level for the activity. Sivoia QS shading solutions provide quiet, precision control of daylight at the touch of a button.

INTEGRATED BLIND AND LIGHT CONTROL SYSTEM WITH GRAFIK EYE® QS AND QS SENSOR MODULE

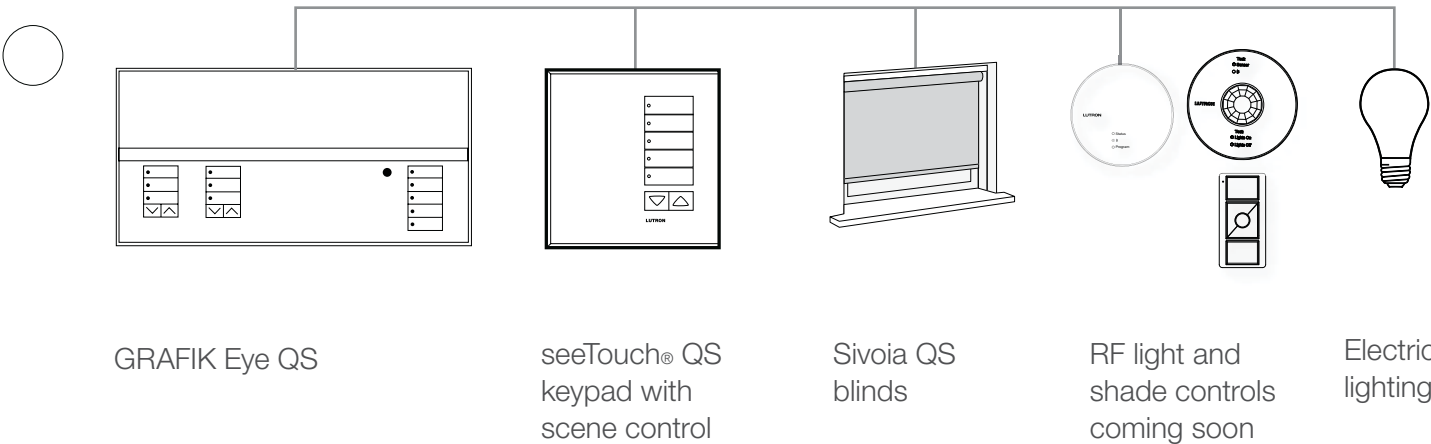

GRAFIK Eye QS

seeTouch® QS keypad with scene control

Sivoia QS blinds

RF light and shade controls coming soon

Electric lighting

TOTAL LIGHT CONTROL

Sivoia® QS shading solutions integrate seamlessly with electric lighting controls for total light management. Create and recall light scenes by automatically adjusting electric and daylight zones at the touch of a button.

Explore the following solutions to understand how total light control can enhance your space.



General setting



Meeting setting

Beyond seating arrangements and AV equipment, lighting is a key element in a function room with changing needs. Lutron® Sivoia® QS roller blinds transform a space from reception hall to conference room and back.

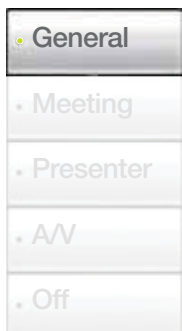

The blinds are open, filling the room with daylight and revealing the view to create an impressive, yet welcoming, environment for clients. The lights are dimmed to conserve energy without sacrificing an evenly illuminated conference space.

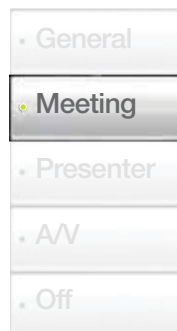

Blinds are lowered to eliminate unwanted glare from direct sunlight, thereby maximising comfort during meetings.



Presenter setting



seeTouch® QS keypad

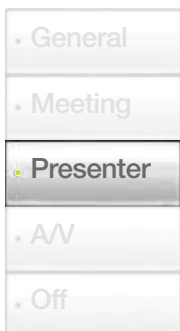

Blinds close completely to darken the room for a presentation while adding a stylish, elegant touch to the space. General light levels are low to provide sufficient light for note-taking.

seeTouch® QS keypads provide control points throughout a space. Control blinds, curtains, and lighting scenes at the touch of a button.



General setting



Meeting setting

Conference rooms demand flexible control in order to accommodate a number of activities. Adjust blinds and lights for roundtable discussions, presentations, and even cleanup.

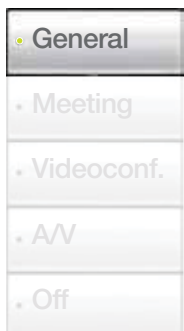

Blinds are open to allow daylight in, brightening the room to energise the staff for a morning meeting. The lights by the window are dimmed to save energy.

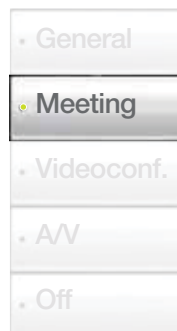

Silently lower sheer blinds to reduce glare and solar heat gain, while preserving the view in this west-facing conference room. The lights put the focus on the table for an afternoon meeting.



A/V setting



Preset

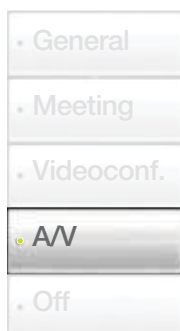

Blackout blinds lower through side channels to completely block daylight. General light levels are set low to ensure maximum visibility of the screen with enough light for note-taking.

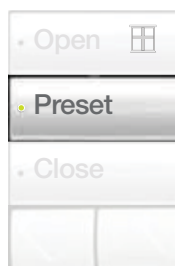

Multiple blind and curtain groups can be controlled independent of scenes with the GRAFIK Eye® QS.

TOTAL LIGHT CONTROL | RESIDENTIAL



General setting



TV setting

With Lutron®, choose the perfect light levels for different activities and occasions throughout the home. Transform the living room for family gatherings, reading, watching a movie, or entertaining.

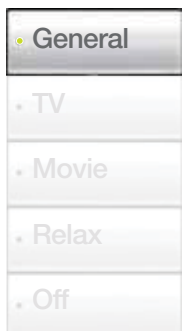

The blinds are partially open to reveal the view and take advantage of daylight for activities such as games or cleaning. The lights are off to save energy.

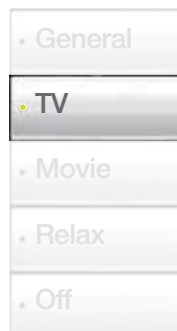

The TV scene creates a casual atmosphere. Blinds are partially closed to create privacy and lights are set at a medium level.



Movie setting



Preset

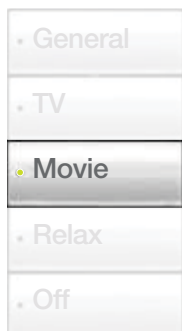

A single button quietly lowers blinds and lights for the perfect movie setting. Blackout blinds close to block daylight and ensure a clear view of the screen without reflections or glare. Lights are dimmed for optimum viewing conditions.

Blinds can be controlled independently or as part of lighting scenes for added flexibility with GRAFIK Eye® QS.

SHADING SOLUTIONS

CONTROL OPTIONS

(One common communication link)

SIVOIA QS ROLLER BLIND

- Provides ultra-quiet, precision control of daylight
- Sheer, dim-out, and blackout fabrics available in a variety of colours and styles
- See pages 12-15 for more information



SIVOIA QS CURTAIN TRACK

- System allows for pinch pleat and ripplefold style options
- Right draw, left draw, center draw, and tandem systems available
- Customer-supplied curtains
- See pages 16-17 for more information



SIVOIA QS SKYLIGHT BLIND

- Smooth, quiet, precise movement of skylight blinds
- Sheer, dim-out, and blackout fabrics available in a variety of colours and styles
- See pages 18-19 for more information

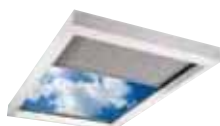

SEETOUCH® QS KEYPADS

- Control blinds, curtains, lights, or any combination in one space
- Available in a variety of styles and button configurations
- Optional raise/lower buttons and an infrared sensor available



SIVOIA QS INFRARED CONTROLS

- Provides personal control of an individual blind/curtain or groups of blinds/curtains
- Offers open, close, preset and raise/lower control of blinds and on, off, and raise/lower of lights from anywhere in the space



RF CONTROLS (COMING SOON)

- Easy installation of wireless sensors and controllers
- Connect the QS sensor module to the QS link for communication with wireless light and shade control devices in the space
- Features Lutron reliable Clear Connect™ Radio Frequency technology



POWER AND INTEGRATION

QS SMART PANEL POWER SUPPLY

- Provides power and communication wiring to Sivoia QS blinds, keypads, and other devices
- Manual override buttons for system verification
- Built-in link diagnostics for easy confirmation of system wiring and communication



INDIVIDUAL POWER SUPPLY

- Provides power to a single blind or curtain



ETHERNET/RS232 INTERFACES

- Allow for seamless integration of lights and blinds with AV and building management systems



INPUT/OUTPUT DEVICE

- Simple, third party interface with contact closure input



LIGHTING CONTROL/ INTEGRATION

GRAFIK EYE® QS

- Preset control of both lighting and shading zones
- Astronomic and programmable time clock provides scheduling of blind and/or light level adjustments for automated convenience
- Information display provides data about energy savings, lighting levels, and time clock information
- Connection port for IR receiver, PC, and occupancy sensor



QUANTUM® AND HYPERION™

- Optimises use of light in a whole building or campus
- Configure, control, monitor and report on all the lighting in a building from a central location
- Maximise the use of daylight and minimise electric lighting waste

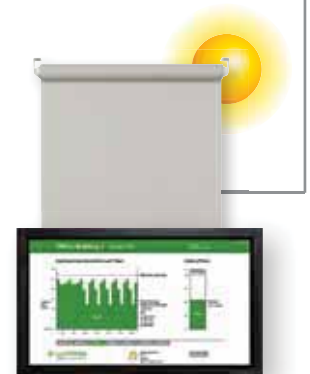



Small-to-medium-sized windows



Floor-to-ceiling windows

Sivoia® QS blinds are the ideal solution for ultra-quiet, precision control of daylight. Roller blinds are available in different sizes to accommodate the needs of any application.

SMALL-TO-MEDIUM-SIZED WINDOWS

roller 20™ and roller 64™ have small tube diameters that make them the perfect solution for small-to-medium-sized windows. Control daylight and create privacy in the office or at home.

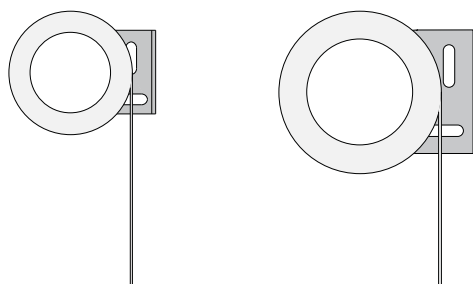

FLOOR-TO-CEILING WINDOWS

roller 100™ and roller 150™ are designed for larger windows, such as those in floor-to-ceiling applications. These windows are often found in offices and condominiums. Preserve the view while increasing productivity.

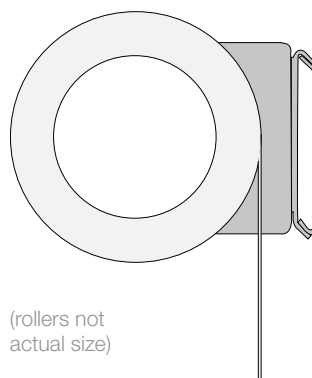



Curtain walls



Multi-story windows

CURTAIN WALLS

Couple up to 6 blinds as a group with a single Electronic Drive Unit (EDU) with roller 150 or roller 200 CW.

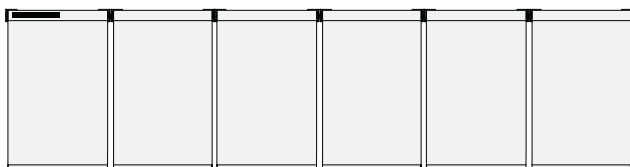

MULTI-STOREY WINDOWS

roller 225™ provides a heavy-duty bracket and higher torque for much larger applications. Add precision control of daylight in atriums, lobbies, and in areas with multi-storey windows.

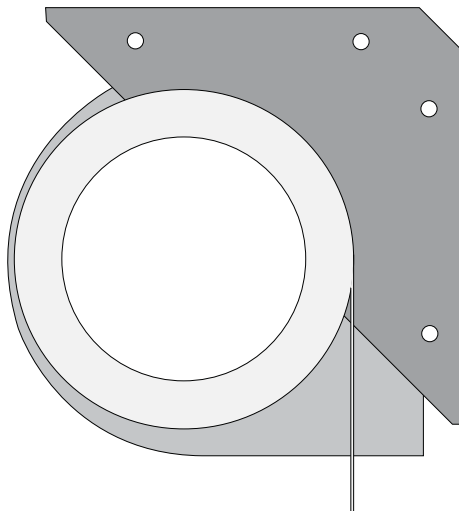

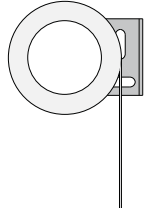
**ROLLER 20™**

Tube size: 32 mm diameter

Pocket size: 89 mm w x 89 mm h

Typical maximum size*: 1.86 sq. m

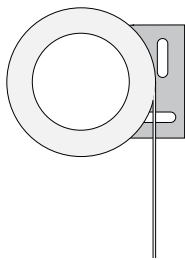
**ROLLER 64™**

Tube size: 41 mm diameter

Pocket size: 89 mm w x 89 mm h

Typical maximum size*: 5.95 sq. m

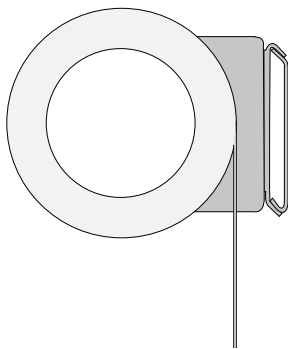
**ROLLER 100™, ROLLER 150™, AND ROLLER 200CW**

Tube size: 65 mm diameter

Pocket size: 121 mm w x 127 mm h

ROLLER 100

Typical maximum size*: 9.29 sq. m

ROLLER 150

Typical maximum size*: 14 sq. m

ROLLER 200CW

Typical maximum system size*: 18.6 sq. m

(up to 6 blinds, 18.6 sq. m total)

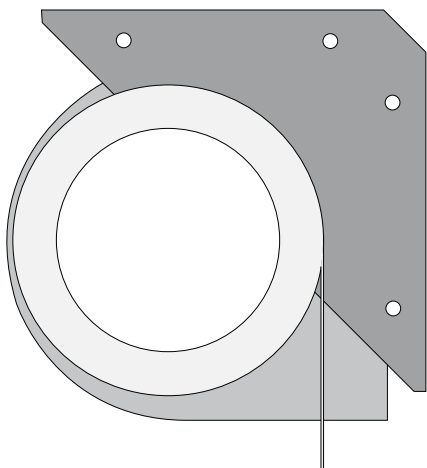
**ROLLER 225™**

Tube size: 95 mm diameter

Pocket size: 178 mm w x 178 mm h

Typical maximum size*: 20.9 sq. m

* Larger blinds may be available based on fabric selection. Contact customer service or use the SCT for actual blind dimensions based on fabric type.

For reliable daylight control that enhances a room's décor, Lutron® provides a superior selection of roller blind fabrics. Sheer, dim-out, and blackout fabrics are available in a variety of colours and patterns. PVC-free, 100% recycled, or OekoTex® Standard 100 Certified fabrics are also available.

Our fabrics are divided into two premium collections:

THE GALLERY COLLECTION BY LUTRON

The new Gallery Collection is comprised of sophisticated designs for residential applications. All fabrics are sustainable.

Categories:

- **Sheer:** sunlight is filtered while preserving the view
- **Dim-out:** permits some light, but view is limited to shapes and shadows

THE CLASSICO COLLECTION BY LUTRON

The Classico Collection offers durable performance fabrics that are also stylish. Perfect for both commercial and residential applications, this collection offers wider roll widths and fire retardant fabrics.

Categories:

- **Sheer:** sunlight is filtered while preserving the view
- **Dim-out:** permits some light, but view is limited to shapes and shadows
- **Blackout:** prevents all light from passing through the material. Combine with side channels, top treatments, and other components for a complete light seal.

Visit www.lutron.com/fabrics for more information.





Straight tracks



Curved tracks



Sivoia® QS curtain tracks are the ideal solution for controlling customer-supplied curtains that respond to the touch of a button. Operate pinch pleat or ripplefold curtains for quiet, elegant, convenient control of daylight.

STRAIGHT TRACKS

Curtains add a soft, elegant touch to your décor. Control pinch pleat or ripplefold styles on straight tracks using Sivoia QS curtain drives.

CURVED TRACKS

Custom curved tracks are available and add a unique aesthetic to a space that requires specific design needs.





Long tracks

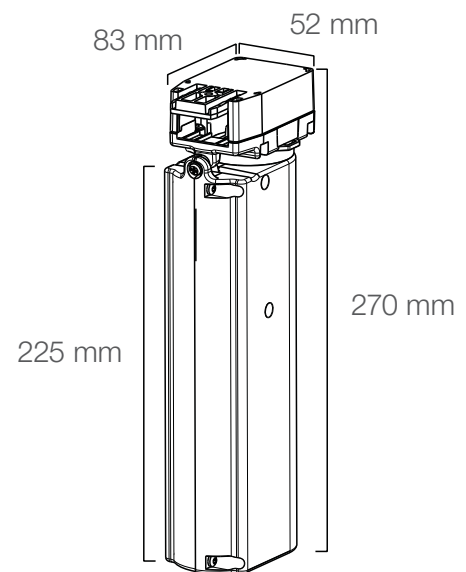

Curtain track drive options

LONG TRACKS

A track splicing option facilitates the shipment and installation of long curtain tracks. Long standard track lengths are up to 9144 mm for a single spliced track or up to 18288 mm for spliced, tandem systems.

CURTAIN TRACK DRIVE OPTIONS

Sivoia QS curtain drives are designed to carry customer-supplied curtains of different weights.

Available options are:

- D105 – for curtains up to 48 kg
- D145 – for curtains up to 66 kg
- D175 – for curtains up to 79 kg

Visit www.lutron.com/draperytrack for drive capacity charts and more information.



Customers can now reliably control daylight through skylights to enhance the visual environment and save energy by reducing solar heat gain. The new skylight blind from Lutron® combines innovative Sivoia® QS technology with a patent-pending tension system. Fabric is kept taut and parallel to skylight windows regardless of slope.

AESTHETICS

- Light-blocking fascia eliminates light gaps around fabric when closed
- Concealed cable guides maximise view through skylight
- Wide variety of high performance fabrics enhance décor

CONTROL

- Smooth, quiet, precise movement of skylight blinds creates elegant transitions
- One-touch control of hard-to-reach skylight blinds through keypad or IR remote
- Seamless integration with other Lutron Sivoia QS products and lighting controls

MOUNTING OPTIONS

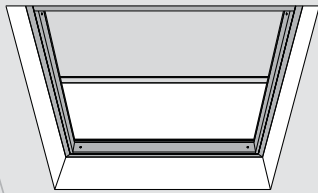

Inside mount

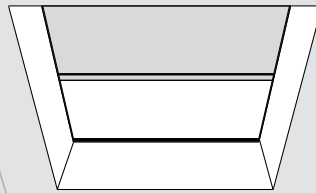

Recessed inside mount

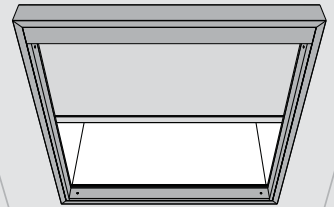

Outside mount (ceiling)

INSTALLATION

- Inside, recessed, and outside mounting options allow system to fit any application
- Flexible installation at any angle between 0° and 45° with consistent aesthetic results
- Pre-assembled shipping available to maximise installation convenience

DESIGN

- Unique tension-absorbing frame eliminates stress on the surrounding ceiling structure
- Reliable performance under extreme temperatures is ensured by weld- and seam-free design
- Scalable design allows for control of skylights up to 6.5 sq. m in size*

Visit www.lutron.com/skylightshade for more information.

* Larger blinds may be available based on fabric selection. Contact customer service or use the SCT for actual blind dimensions based on fabric type.

seeTouch QS keypads control blinds, curtains, lights, or a combination of all three (14 architectural styles and 10 international styles available*). All keypads are available with standard or custom engraving in a variety of colours and finishes.



QSWE-5BRLI-AW-E01

5-button keypad with raise/lower (insert style shown)



SQWE-6BRLN-AW-EGN

Dual lights and 3-button blind keypad with raise/lower (non-insert style shown)



QSWE-8BRLIRN-AW-E01

3 group, 5-button keypad with infrared receiver and raise/lower



QWS2-2RLDI-WH-E01

2-button dual keypad with raise/lower (insert style shown)



QWS2-3BRLIRN-WH-E01

3-button keypad with infrared receiver and raise/lower (non-insert style shown)



QWS2-2RLDN-WH-E01

Dual lights and blinds keypad with raise/lower

* For a complete guide on keypad options with model numbers, please refer to the seeTouch QS wallstation specification submittal at www.lutron.com/SivoiaQS

SATIN COLORS® MATTE FINISHES

(HT) Hot	(TC) Terracotta
(MR) Merlot*	(GB) Greenbriar*
(PL) Plum*	(BG) Bluestone*
(TQ) Turquoise*	(MS) Mocha Stone*
(SG) Sea Glass*	(GS) Goldstone*
(ES) Eggshell	(DS) Desert Stone
(BI) Biscuit	(ST) Stone
(SW) Snow	(LS) Limestone
(PD) Palladium*	
(MN) Midnight	
(SI) Sienna*	

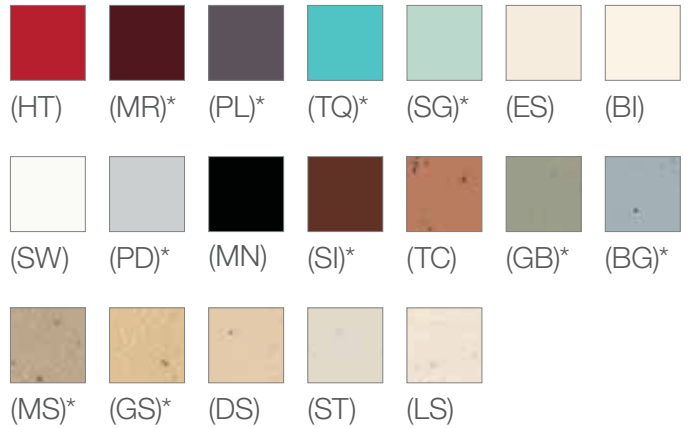

ARCHITECTURAL MATTE FINISH PALETTE

(WH) White	(SI) Sienna*
(BE) Beige	(BR) Brown
(IV) Ivory	(BL) Black
(AL) Almond*	(AW) Arctic White†
(LA) Light Almond*	(AR) Argentum†
(GR) Gray	(MC) Mica†
(TP) Taupe*	



METAL FINISHES PALETTE

(SB) Satin Brass†	(QB) Antique Brass†
(BB) Bright Brass†	(QZ) Antiq. Bronze†
(BC) Bright Chrome†	(SC) Satin Chrome†
(CLA) Clear Anodised Aluminium	(SN) Satin Nickel†
(BLA) Black Anodised Aluminium	(BN) Bright Nickel†
(BRA) Brass Anodised Aluminium	(AU) Gold Plated†

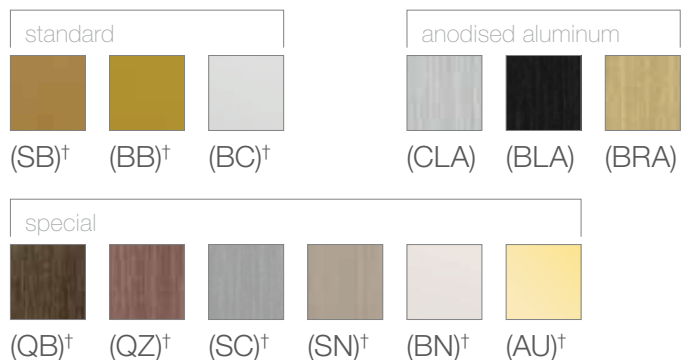

Colour samples shown are representations only. See product samples for exact finishes and ask your Lutron sales representative for colour availability.

* Non-standard colour offering. Contact Customer Service for additional information.

† Colour available on international style see Touch QS keypad

WIRING DIAGRAM

- Maximum 100 devices (Sivoia QS roller blinds, curtain tracks, skylight blinds, seeTouch® QS keypads, GRAFIK Eye QS main units, and QS power supplies) per system
- Maximum 100 zones (Sivoia QS roller blinds, curtain tracks, skylight blinds, and lighting zones on GRAFIK Eye QS)

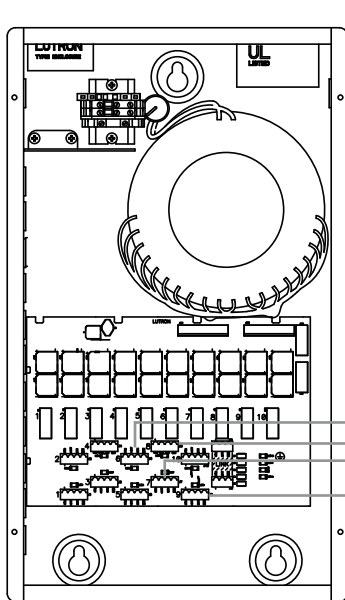

**QS Smart Panel
power supply**

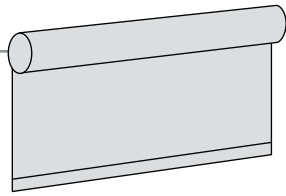

Sivoia® QS roller blind

Up to 60 m
of 4-conductor
twisted/shielded
1.5 mm² wire

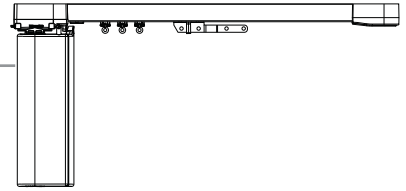

Sivoia QS curtain track

Up to 60 m
of 4-conductor
twisted/shielded
1.5 mm² wire

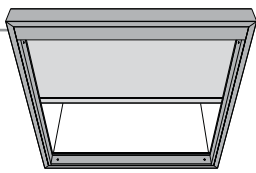

**Sivoia® QS
skylight blind**

Up to 60 m
of 4-conductor
twisted/shielded
1.5 mm² wire

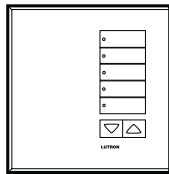

Sivoia QS keypad

Up to 150 m
of 4-conductor
twisted/shielded
1.5 mm² wire

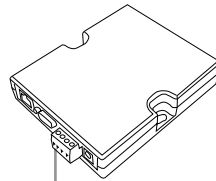

RS232 Interface
(optional for
A/V integration)

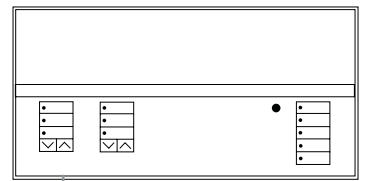

GRAFIK Eye® QS
(optional for total
light control)

Lutron® is the world's leading manufacturer of lighting control and shading systems for over 45 years of experience. We focus on continually innovating, while offering world-class service and support.

CONTROL

ULTRA-QUIET ELECTRONIC DRIVE

The Sivoia® QS system is low-voltage and operates at a near-silent level (rated at less than 44 dBA at 1 meter). Blinds move smoothly and stop at preset positions with no audible clicks.

TOTAL LIGHT CONTROL

Lutron lighting control systems integrate with Sivoia QS blinds and curtains, offering intuitive control of both electric light and daylight. GRAFIK Eye® QS and Sivoia QS use the same wiring configuration and do not require any interfaces, ensuring seamless integration for total light control.

INSTALLATION

SIMPLE RECONFIGURATION

The Sivoia QS system can be easily reconfigured, limits can be changed, and presets can be reprogrammed without rewiring through the remote, keypad, or electronic drive unit (EDU).

SIMPLIFIED WIRING

Sivoia QS shading systems do not require any group controllers, relays, or line-voltage wiring between electronic drive units.

QS SMART PANEL DIAGNOSTICS

The QS Smart Panel power supply features advanced diagnostics to quickly verify system communication and wiring.

FLEXIBILITY AND PERFORMANCE

LIMITS AND PRESETS NEVER LOST

Precise limits and preset blind positions are electronically set and have a power-failure memory for up to 10 years. These limits and presets will never drift regardless of age, electrostatic discharge, or power failure.

SYSTEM WARRANTY AND SUPPORT

Sivoia QS systems come with an 8-year limited warranty, plus optional extended service. Lutron has factory-employed field service engineers throughout the world and is the only lighting control or blind systems manufacturer in the world with a 24-hour, 7 days a week technical support center.

AESTHETICS

MINIMAL, SYMMETRICAL LIGHT GAPS

Sivoia QS roller blinds offer symmetrical light gaps of 19 mm per side.

ELEGANT CONTROL OPTIONS

Lutron controls are designed to match the high-end look and feel of today's premiere working and living spaces. They are available in a wide variety of colours and finishes, including metals.

WIDE ARRAY OF FABRICS

Lutron shading systems are available in fabric styles to suit any function or aesthetic need, including many sustainable fabric choices.



ABOUT LUTRON®

OUR COMMITMENT

Lutron is committed to bringing our customers best-in-class products and solutions that offer superior performance with world-class service and global support.

Light control is environmentally responsible. It enhances life safety, and it enhances security. Lutron develops high-quality, elegant lighting solutions that reduce energy costs significantly. We innovate in advance of emerging market needs and continually streamline our quality, our delivery, and our value.

Lutron owns over 2,700 patents worldwide and manufactures more than 15,000 products. For over 45 years, we have met and exceeded the highest standards of quality and service. Every one of our products is quality-tested before it leaves the factory. We are available to help, on the phone or in the field, whenever we are needed.

UNMATCHED SUPPORT

EXPERT DESIGN ASSISTANCE

- Product, application and system knowledge to identify the best solutions to meet project objectives
- Design assistance for the specification community with drawings and written specifications
- Quick turnaround to meet construction schedules
- Product demonstrations, samples, and installation documentation
- Global project management

EXPERT SERVICE

- Ongoing commitment to service and reliability
- Global field service engineers handle factory commissioning and support
- 24/7 multilingual technical phone support
- Assured performance plans include annual warranty extension, annual comprehensive preventative maintenance, and customised training

Lutron® has been the world's leading manufacturer of lighting controls and systems for more than 45 years. With the addition of Sivoia QED® and Sivoia® QS shading solutions, Lutron has opened up a new world of possibilities by seamlessly integrating electric and daylight control with a focus on innovation, world-class engineering, and customer service. Lutron blends technology with design and environmental sensitivity to provide the ideal solution for total light control.

NEW DELHI (NCR REGION)

Lutron GL
Sales and Services Pvt. Ltd.
Level 6, JMD Regent Square,
Mehrauli Gurgaon Road,
Gurgaon
Haryana – 122001, India
TEL: +91 124 471 1900
FAX: +91 124 471 2001
lutronindia@lutron.com

MUMBAI

Lutron GL
Sales and Services Pvt. Ltd.
Trade Centre, Regus,
1st Floor, Bandra Kurla Complex,
Bandra (E)
Mumbai – 400051, India
TEL: +91 22 4070 0867
FAX: +91 22 4070 0800
lutronindia@lutron.com

BANGALORE

Lutron GL
Sales and Services Pvt. Ltd.
15th Floor, Concorde Towers,
U.B.City, 1 Vittal Mallya Road,
Bangalore – 560001, India
TEL: +91 80 4030 0485
FAX: +91 80 4030 0400
lutronindia@lutron.com

INTERNATIONAL OFFICES

US: Worldwide Headquarters

TEL: +1 610 282 3800

UK: European Headquarters

TEL: +44 20 7702 0657

Singapore: Asian Headquarters

TEL: +65 6220 4666

Brazil: São Paulo

TEL: +55 11 3257 6745

China: Beijing

TEL: +86 10 5877 1818

China: Hong Kong

TEL: +852 2104 7733

China: Shanghai

TEL: +86 21 6288 1473

France: Paris

TEL: +33 1 56 52 93 01

Germany: Berlin

TEL: +49 (0)30 971045-90

Italy: Milan

FREEPHONE: 800 979 208

Japan: Tokyo

TEL: +81 3 5575 8411

Spain: Barcelona

TEL: +34 93 496 57 42

Spain: Madrid

TEL: +34 91 567 84 79

UAE: Dubai

TEL: +971 4 299 1224



www.lutron.com/asia | www.lutron.com/sivoiaqs

© 11/2010 Lutron Electronics Co., Inc. | P/N 367-1374/IN REV B