



cost-effective energy code solutions

Softswitch128™ for ASHRAE 90.1 and Title 24 code requirements



Parking and site lighting application

Bill of materials and one-line diagrams shown for a parking and site lighting project with 8 circuits and time-based events.

Softswitch128™ system

Qty.	Description
1	XPS8-277FT, 8-relay feed through panel

Total Material \$ 834

Sales Tax (7.5%) \$ 63

Labor – mounting prep
(1/2 hr. @ \$55/hr.) \$ 28

Labor – panel installation
(2 hrs. @ \$55/hr.) \$ 110

Total Project Cost \$ 1,035



8-relay feed through panel with built-in astronomical time clock

Contactor system

Qty.	Description
2	Four-pole 277V lighting contactor
1	Enclosure
1	Astronomical time clock

Total Material \$ 613

Sales Tax (7.5%) \$ 46

Labor – mounting prep and wiring
(5 hrs. @ \$55/hr.) \$ 275

Labor – contactor installation
(3 hrs. @ \$55/hr.) \$ 165

Labor – time clock installation
(2 hrs. @ \$55/hr.) \$ 110

Total Project Cost \$ 1,209

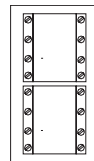

Astronomical time clock

(2) Four-pole lighting contactors in one enclosure

Note: Estimated end-user cost. Actual pricing may vary.

Library application

Bill of materials and one-line diagram shown for a five-floor library with 240 circuits and time-based events. Each floor operates separately. Floors 1, 2 and 3 each have two panels; floors 4 and 5 each have one panel.

Softswitch128™ system

Qty.	Description
4	XPS28-1204ML-20, 28-relay panel with branch circuit breakers
4	XPS32-1204ML-20, 32-relay panel with branch circuit breakers

Total Material \$ 34,560

Sales Tax (7.5%) \$ 2,592

Labor – mounting prep
(24 hrs. @ \$55/hr.) \$ 1,320

Labor – panel installation
(96 hrs. @ \$55/hr.) \$ 5,280

Total Project Cost \$ 43,752

Floors 1-3

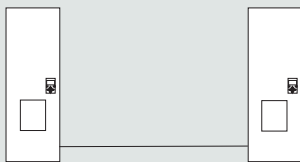

28-relay panel with branch circuit breakers and built-in astronomical time clock

32-relay panel

Floor 4

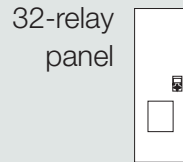

32-relay panel

Floor 5

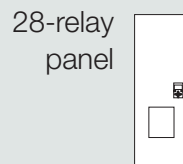

28-relay panel

Contactor system

Qty.	Description
20	12-pole 120V lighting contactor
20	Enclosure
8	Distribution panel with breakers
5	Astronomical time clock

Total Material \$ 20,750

Sales Tax (7.5%) \$ 1,556

Labor – mounting prep and wiring
(180 hrs. @ \$55/hr.) \$ 9,900

Labor – contactor installation
(108 hrs. @ \$55/hr.) \$ 5,940

Labor – time clock installation
(72 hrs. @ \$55/hr.) \$ 3,960

Total Project Cost \$ 42,106

Floors 1-3

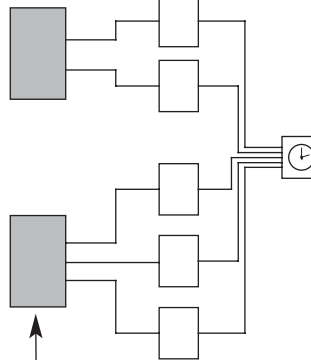

Distribution panel with breakers

Enclosure with 12-pole contactor

Floor 4

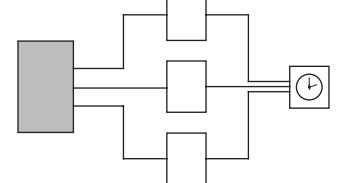

Floor 5

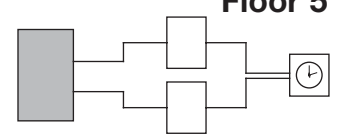

Note: Estimated end-user cost.
Actual pricing may vary.

ASHRAE/IESNA 90.1 Standard and IECC Energy Code

Many states have adopted energy codes for commercial buildings. Softswitch128™ switching systems provide solutions for the following requirements:

- Exterior lighting control – built-in astronomical time clock or optional exterior daylight sensor.
- Automatic shutoff – built-in astronomical and time-of-day time clock.
- Space control – local wallstations or occupancy sensors.

www.lutron.com/switching

Softswitch128 switching systems also offer the following features:

- CEC/Title 24 compliant.
- Panels are pre-assembled, pre-wired, and UL-listed.
- Contractor-friendly rough-in option available.
- Patented Softswitch™ relay is rated to last a minimum of 1,000,000 cycles.



www.lutron.com

Lutron Electronics Co., Inc.
7200 Suter Road
Coopersburg, PA 18036-1299

World Headquarters 1.610.282.3800

Offices Worldwide

Barcelona | Beijing | Berlin | Guangzhou | Hong Kong | London | Madrid | Mexico City |
Milan | Paris | Rome | Sao Paulo | Shanghai | Singapore | Tokyo

Technical Support Center 1.800.523.9466
Customer Service 1.888.LUTRON1

Cover photograph © Timothy Hursley.

© 06/2006 Lutron Electronics Co., Inc. | Made and printed in U.S.A. | P/N 367-914