

Finiré 3" with Warm Dimming

Luxury LED Recessed Lighting by Ivalo



Guaranteed Lutron control compatibility

- Guaranteed Lutron control compatibility
- Standard Lutron 1% dimming driver with EcoSystem Soft-on, Fade-to-Black options
- Provides a warm, incandescent-like look and feel
- EcoSystem option digitally allows individual fixture control
- 10-year limited warranty

©Lutron, Finiré, Hi-lume, Ivalo, HomeWorks, GRAFIK Eye, and EcoSystem are trademarks of Lutron Electronics Co., Inc, registered in the U.S. and other countries.

Soft-on and Fade-to-Black are trademarks of Lutron Electronics Co., Inc.



lutron.com/finire

Lutron Electronics Co., Inc.
7200 Suter Road
Coopersburg, PA 18036-1299

Customer Service and 24/7 Technical Support:
610.282.7472 or fixtures@lutron.com

© 02/2019 Lutron Electronics Co., Inc.
Printed in the U.S.A.
P/N 367-2818 REV B





Why Choose Finiré 3" with Warm Dimming

The Ivalo Difference



Guaranteed compatibility*

Worry-free compatibility with Lutron controls



Standard 1% dimming

Standard Lutron driver with EcoSystem Soft-on, Fade-to-Black option



24 hr service

LED Control Center of Excellence and 24/7 technical support

Features and Benefits

Lutron quality

10-year limited warranty

Excellent color rendering

95 CRI, 85 R9 LED color quality

High efficacy

Up to 850 delivered lumens
Title 24 compliant options

Color temperature options

Choose 3000K–1800K or 2700K–1800K
Color consistency 2-step Macadam Ellipse

Dimming Curve

Light Level Percentage vs. Correlated Color Temperature (CCT)

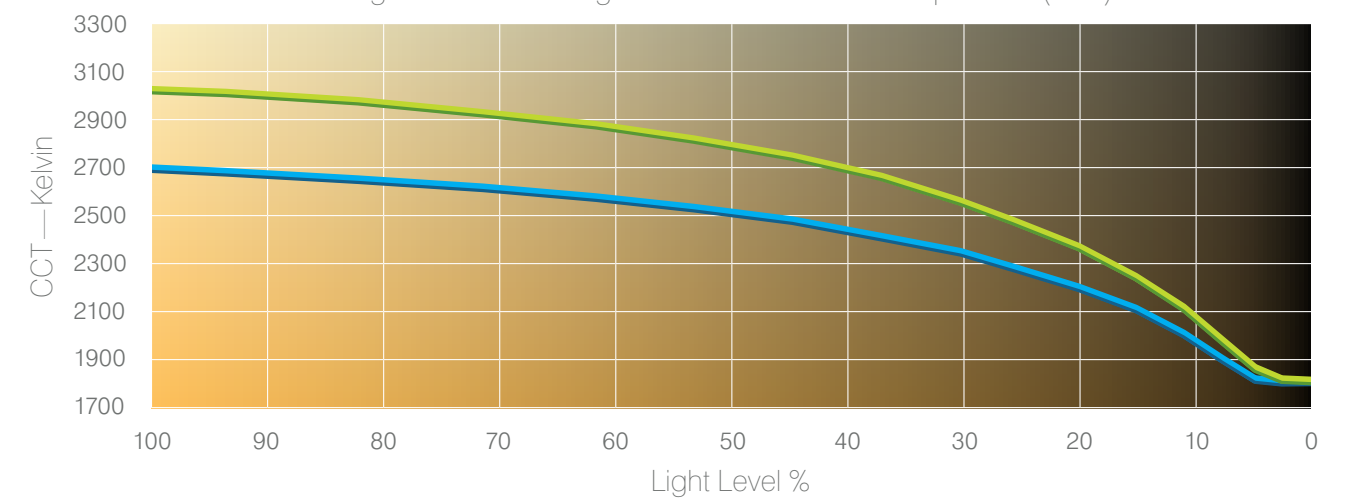

*For a list of compatible controls, visit lutron.com/finire or contact the LED Control Center of Excellence at leds@lutron.com and 1.877.DIM.LED8.

3" with Warm Dimming Fixture Types and Options



Finiré 3" with Warm Dimming fixtures come standard with high quality 95 CRI LEDs and the Lutron 1% dimming driver that guarantees Lutron control compatibility. A range of features including soft-on, fade-to-black, hot aiming, and warm dimming profiles that match incandescent and halogen lighting, make this new family ideal for high-end residential applications.

Fixture Types and Options

Type	Downlight, Adjustable, Infinite Adjustable
Size (opening)	3"
Housing	Non-IC, IC
Aperture Style	Round, Square
LED Type	17W, 850lm, 95 CRI 29W, 1600lm, 95 CRI (Non-IC only)
Color Temperature	2700K – 1800K 3000K – 1800K
Beam Spread	30°, 40°, 50°, 55°
Trim	Round Trimmed, Round Trimless, Round Pinhole Square Trimmed, Square Trimless, Square Pinhole
Hanging	14–24" Adjustable Hanging Bars 9.5–15" Adjustable Narrow Joist Hanging Bars
Control Method	2-Wire, 120V~ EcoSystem, 120/277V~ * EcoSystem comes standard with Soft-on, Fade-to-Black dimming feature
Ceiling Thickness	Standard (1/2"–5/8") Thick Ceiling (custom up to 2") Trimless Wood/Stone (.5"–1.5")

3" with Warm Dimming Specifications

LED Performance

Finiré Model	Standard	High Output Plus
CRI (Typical)	95, R9=85	95, R9=85
Lumens (Delivered)	850	1600
Wattage	17	29
Efficacy (Lumens/Watt)	50+	50+

Independent measurement of typical 3000K downlight fixture models by Lutron Electronics Co., Inc. for reference only. See the Finiré specification sheets for LM79 photometric data by fixture type and trim options.

IC Housing*

Side view (Trimless)

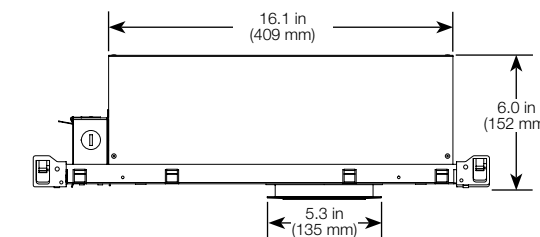

Bottom view (Trimless)

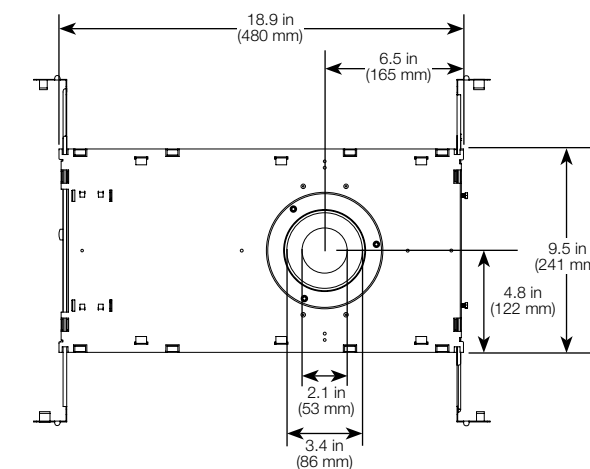

* Plenum rated fixture uses IC housing

Dimensions

Non-IC Housing: 13.6"L x 9.5"W x 4.9"H
IC Housing: 18.9"L x 9.5"W x 6.0"H
Max Ceiling Thickness: 2.0"

Non-IC Housing

Side view (Trimmed)

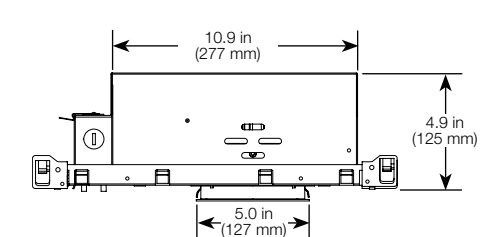

Bottom view (Trimmed)

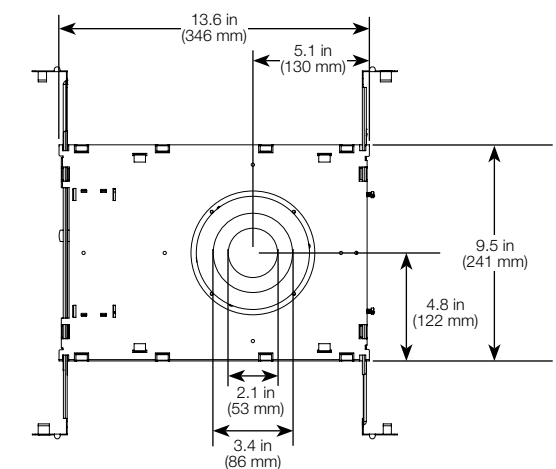









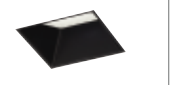

Compatible Controls

For a list of compatible controls, visit lutron.com/finire or contact the LED Control Center of Excellence at leds@lutron.com/1.877.DIM.LED8.

For spray foam insulation application details, contact fixtures@lutron.com.

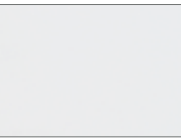
3" Options

Trim Options	Square Trimmed Adjustable	Square Trimless Adjustable	Square Trimmed Downlight	Round Trimmed Downlight	Square Trimmed Downlight	Round Trimless Downlight	Round Trimmed Adjustable
Shown in:	 Matte White	 Matte Black	 Silver	 Bronze	 Silver/White	 Clear Anodized	 Clear Chrome

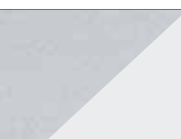
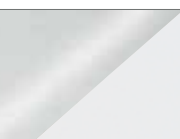
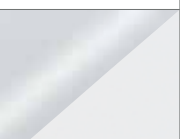
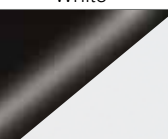
Finish	Matte White	Matte Black	Silver	Bronze
				
	Silver/White	Clear Anodized/White	Clear Chrome/White	Black Chrome/White
				

White flange standard for trimmed options

Pinhole Trim Options	Square Pinhole Downlight	Round Pinhole Downlight	Square Trimless Pinhole Downlight	Round Trimless Pinhole Downlight	Round Pinhole (Slotted) Adjustable	Round Trimless Pinhole (Slotted) Adjustable
						

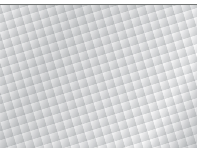
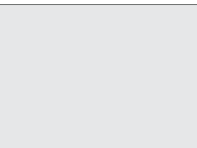
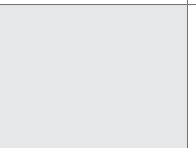
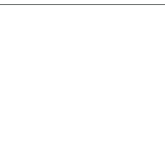
Lens Options	Micro Prism Solite™	Frosted Glass	Wall Wash	No Lens
				

Note: All lens options (except no lens) are wet (damp) location rated for covered, ceiling mount interior or exterior applications that meet the required temperature spec.

How to specify Finiré 3" LED Recessed Lighting

F D T 3 R N WX 27 40 F1 XX XX - RTD00 MW FG XX
 1 2 3 4 5 6 7 8 9 10 11 12 13 14 15 16

Fixture Options

- Family**
F = Finiré Recessed Lights
- Type**
D = Downlight
A¹ = Adjustable (accommodates sloped ceilings up to 10/12 roof pitch)
I¹ = Infinite Adjustable with Hot Aiming
- Flange**
T = Trimmed
Z = Trimless
- Series**
3 = 3" Series
- Shape**
R = Round
S = Square
- Housing Type**
N = Non-Insulation Contact (Non-IC)
I = Insulation Contact (IC)
- LED Type**
WX = Standard 17W, 850lm, 95 CRI
WH⁷ = High Plus 29W, 1600lm, 95 CRI
- Color Temperature**
27 = 2700K – 1800K
30 = 3000K – 1800K
- Beam Spread**
30 = 30 degrees*
40 = 40 degrees
50 = 50 degrees
55 = 55 degrees*
- Control Method**
F1 = Hi-lume 1% 2-wire Driver, 120 V~
EU² = Hi-lume 1% EcoSystem Driver, 120/277 V~
- Hanging**
XX = 14–24" Adjustable Standard
NJ = 9–15" Adjustable Narrow Joist
- Ceiling Thickness**
XX = Standard (1/2"–5/8")
PL = Plenum Rated
TW³ = Trimless Wood/Stone (.5"–1.5")
TT = Trimless Thick Ceiling greater than 5/8" but less than 2"

Trim Options

- Trim**
RTD00 = Round Trimmed Downlight
RTA00 = Round Trimmed Adjustable
RTP00⁴ = Round Pinhole Downlight
RTS00⁴ = Round Pinhole (Slotted) Adjustable
RZD00 = Round Trimless Downlight
RZA00 = Round Trimless Adjustable
RZP00⁴ = Round Trimless Pinhole Downlight
RZS00⁴ = Round Trimless Pinhole (Slotted) Adjustable
STD00 = Square Trimmed Downlight
STA00 = Square Trimmed Adjustable
STP00⁴ = Square Pinhole Downlight
SZD00 = Square Trimless Downlight
SZA00 = Square Trimless Adjustable
SZP00⁴ = Square Trimless Pinhole Downlight
- Finish**
MW = Matte White
BL = Matte Black
SI⁵ = Silver
RB⁵ = Bronze
SW^{5,6} = Silver/White
CA⁶ = Clear Anodized/White
CC⁶ = Clear Chrome/White
BC⁶ = Black Chrome/White
- Lens⁸**
XX = No Lens
FG = Frosted Glass
SO = Micro Prism Solite™
WW¹ = Wall Wash
- Options**
XX = None
TC = Thick Ceiling (greater than 5/8" up to 2")

Need quote, layout, or custom assistance?
Email fixtures@lutron.com or call 610.282.7472.

For details on CEC Title 24 compliant options, please contact fixtures@lutron.com.

¹ For wall wash applications, use adjustable or infinite adjustable housing with adjustable trim and wall wash lens. For best results, use with 40° beam spread at 40° tilt angle
² Includes Soft-on, Fade-to-Black dimming
³ For trimless wood/stone use trimless housing and trim
⁴ Pinhole trims come in Matte White, Matte Black, Silver, and Bronze with Black inside baffle
⁵ Painted finish
⁶ White flange standard for trimmed options
⁷ Non-IC housing type only
⁸ All lens options (except no lens) are wet/damp location rated for covered, ceiling-mount interior or exterior applications that meet the required temperature spec.