

## QS Keyswitch

### Features

- Provides key-only access to QS lighting controls.
- Recalls preset light levels for any 2 scenes including Off.
- Allows fine-tuning (raise/lower level) of a zone or group of zones.
- Starts/Stops scene sequencing.
- Enables/Disables timeclock.
- Enables/Disables occupancy sensors.
- Enables/Disables daylight sensors.
- Allows associated Zones to be turned On/Off.
- Enables/Disables panic mode.
- Starts/Stops afterhours mode.
- Opens/Closes a shade or group of shades.
- Works with GRAFIK Eye® QS and Quantum® systems.



Non-Insert Style



Insert Style  
(standard decorator opening)

Note: For applications involving Energi Savr Node™ and Homeworks® QS systems, contact Lutron.

### Finish, Engraving, and Key Options:

See following pages for options; also available with custom engraving to meet specific project needs. Replacement keys available (model number REP-KS-KEY). Contact Lutron for details.

<p>Job Name:</p>  <p>Job Number:</p>	<p>Model Numbers:</p>
--	-----------------------

# How to Build a Model Number

## Example:

### QSWS2-KS

QSWS2-KSN3MOC-WH:  
Non-insert, 3-position, momentary, key removable from center only, white

**I** = Insert  
**N** = Non-Insert

#### Available Key Settings:

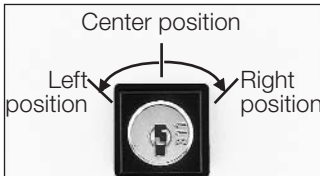

**3MOC**: 3-position  
**M**omentary  
**C**enter position key removal  
± 45° travel

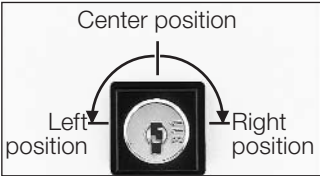

**3MAC\***: 3-position  
**M**aintained  
**C**enter position key removal  
± 90° travel

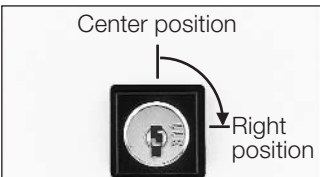

**2MAC\***: 2-position  
**M**aintained  
**C**enter position key removal  
± 90° travel

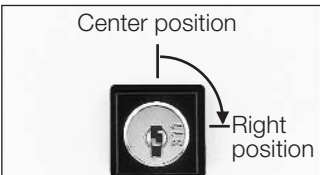

**2MAA\***: 2-position  
**M**aintained  
**A**ny position key removal  
± 90° travel

Color Code:  
**WH** = White  
**BE** = Beige  
**IV** = Ivory  
**GR** = Gray  
**BR** = Brown  
**BL** = Black  
**AL** = Almond  
**LA** = Light almond

\*3MAC, 2MAC, and 2MAA keyswitches are available as custom products (CPN5432). Contact Lutron for details.

Job Name:	Model Numbers:
Job Number:	

## Specifications

### Power

SELV/PELV/NEC® Class 2

Operating voltage: 24–36 V $\overline{=}$  30 mA.

Uses 1 Power Draw Unit (PDU) on the QS Link

### Key Design Features

- Tested to withstand 16 kV electrostatic discharge without damage or memory loss.
- Faceplate snaps on with no visible means of attachment.
- Insert version can be ganged with other controls using any standard decorator multigang faceplate. For non-insert version ganging, contact Lutron for custom faceplate options.

### System Communications and Capacity

- SELV/PELV/NEC® Class 2 wiring connects wallstations to processor panel.
- Counts as 1 device toward the QS system maximum of 100.

### Terminals

12 AWG to 22 AWG wire (0.5 mm<sup>2</sup> to 4.0 mm<sup>2</sup>)  
Each accepts up to two 18 AWG (1.0 mm<sup>2</sup>) typical.

### Environment

- 32 °F to 104 °F (0 °C to 40 °C). Relative humidity less than 90% non-condensing.
- For indoor use only.

## Dimensions

Front View

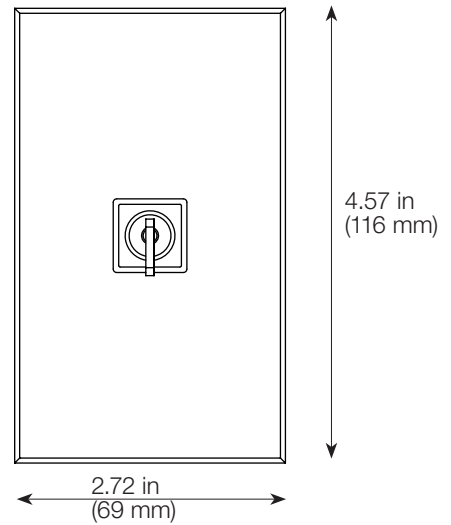

Side View

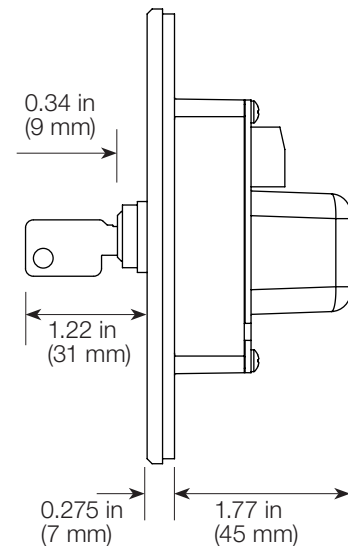

Back View

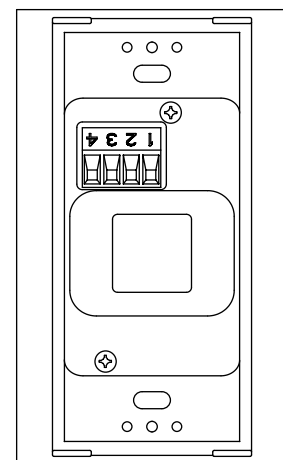

Job Name:

Model Numbers:

Job Number:

### Mounting

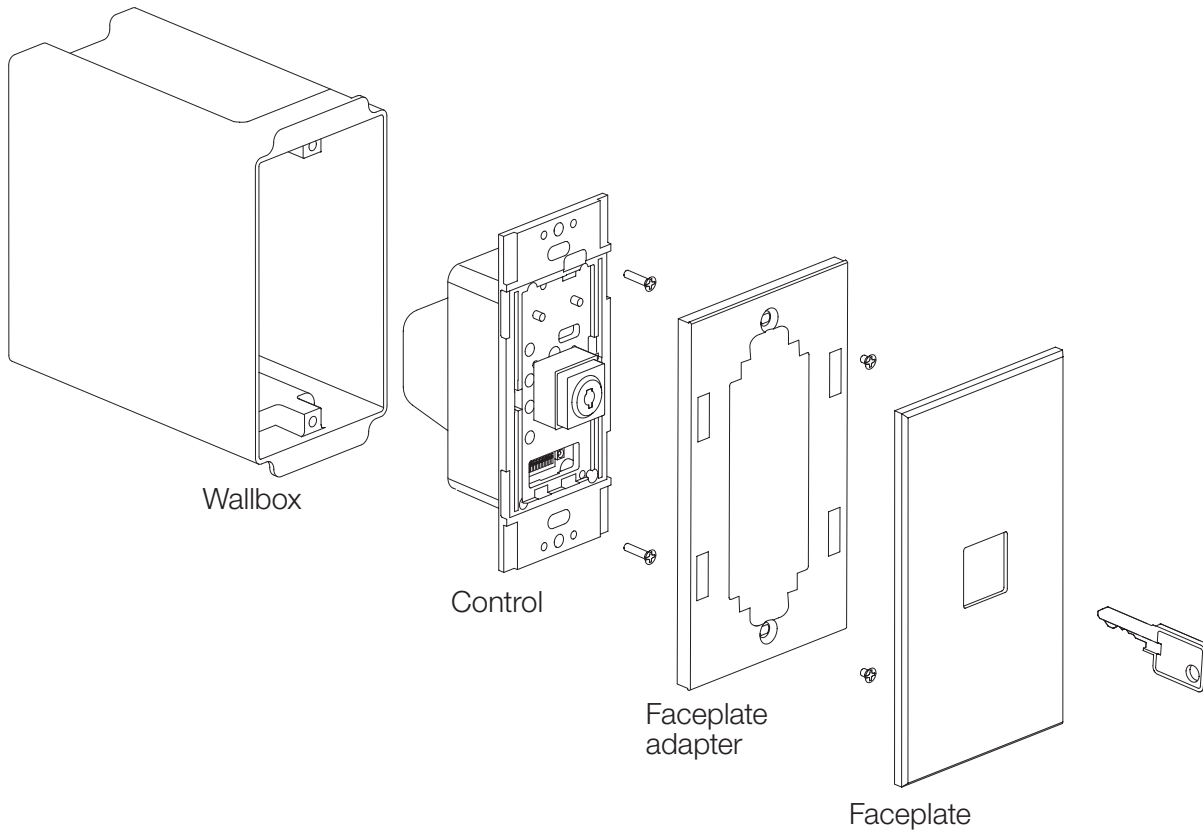

### Installation

#### SELV/PELV/NEC® Class 2 Wiring

- Use SELV/PELV/NEC® Class 2 wiring to connect wallstations to the QS link. Connections may be daisy-chain, star or T-tap configurations.
- Connect Drain/Shield as shown. Do not connect to Ground (Earth) or wallstation. Connect the bare drain wires and cut off the outside shield.

QS Link Wiring Length	Wire Gauge	Available from Lutron in one cable:
Less than 500 ft (153 m)	Power (terminals 1 and 2): 1 pair 18 AWG (1.0 mm <sup>2</sup> )	GRX-CBL-346S GRX-PCBL346S
	Data (terminals 3 and 4): 1 pair 22 AWG (0.5 mm <sup>2</sup> ), twisted and shielded	
500 ft to 2000 ft (153 m to 610 m)	Power (terminals 1 and 2): 1 pair 12 AWG (4.0 mm <sup>2</sup> )	GRX-CBL-46L GRX-PCBL-46L
	Data (terminals 3 and 4): 1 pair 22 AWG (0.5 mm <sup>2</sup> ), twisted and shielded	

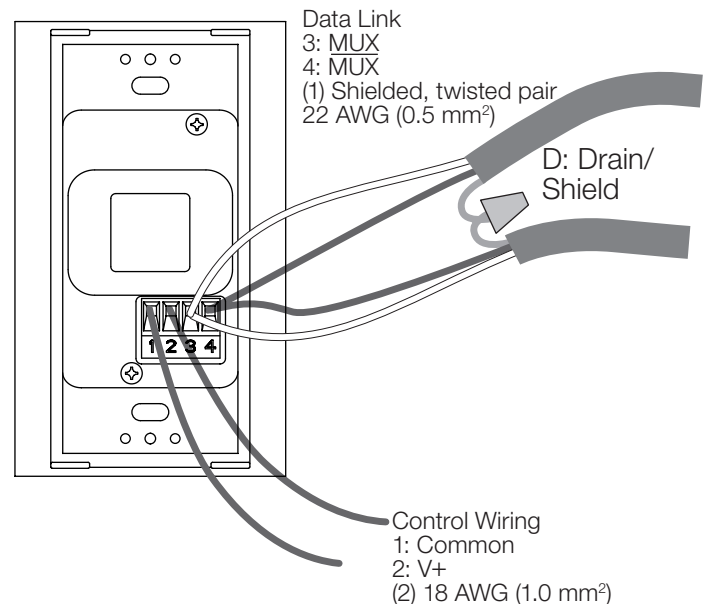

Job Name:	Model Numbers:
Job Number:	

## Operation

Front View (faceplate removed)

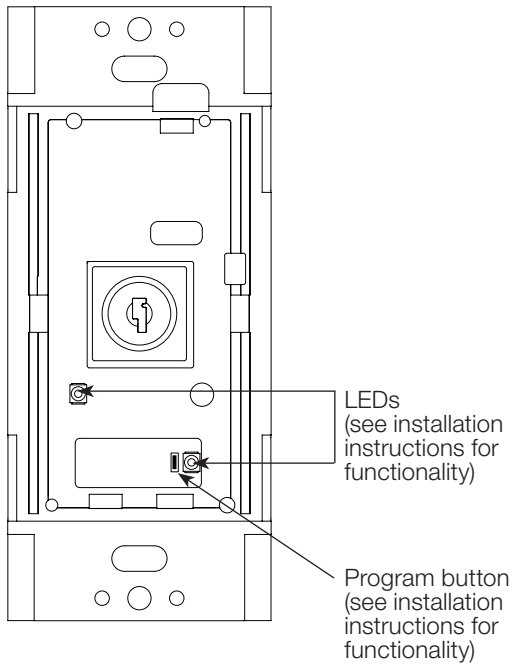

## Ganging

- Order Insert (I) style controls.
- To order Wallplates for multi-ganging, specify “R3” openings in a NovaT★ multi-gang FB (fins broken) Series model number.

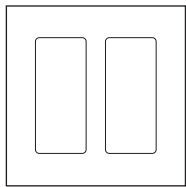

Example:  
Wallplate for 2 QS Keyswitches,  
Model # NT-R3-R3-FB-(color)

Job Name:	Model Numbers:
Job Number:	

## Keyswitch Functionality

Some keyswitch models are more appropriate than others for the available functions. Please refer to the table and notes below and the specific function diagrams on the following page to set up your keyswitch.

Keyswitch Function	Keyswitch Model			
	3MOC	3MAC	2MAC	2MAA
Scene Select*	X	X	X	X
Zone Preset	X	X	X	X
Fine Tune Zones	X	Not recommended	Not recommended	Not recommended
Sequence Start/ Stop	X	Not recommended	Not recommended	X
Timeclock Enable/ Disable	X	Not recommended	Not recommended	X
Afterhours Start/ Stop	X	Not recommended	Not recommended	X
Panic Enable/ Disable	X	Not recommended	X	X
Daylight Sensor Enable/Disable	X	Not recommended	Not recommended	X
Occupancy Sensor Enable/Disable	X	Not recommended	Not recommended	X
Shade Raise/Lower	X	Not recommended	Not recommended	Not recommended

**\*Note:** Scene functionality is limited to toggling between two scenes. Choose from any of the 16 available scenes and Off or any two consecutive scenes (e.g., Scenes 5 and 6). In either case, the scene with the higher number (never the Off scene) is activated by turning the key to the right position, and the scene with the lower number (or the Off scene, if applicable) is activated by turning the key to the left position (for a 3-position keyswitch) or center position (for a 2-position keyswitch).

**Note:** For applications involving Energi Savr™ Node and Homeworks® QS systems, contact Lutron.

Job Name:	Model Numbers:
Job Number:	

**QSWS2 Keyswitch Functions**

The following functions are available for a QS Keyswitch.

**Scene Select:** Goes to a preset scene. See the Note on the previous page.

**Zone Preset:** Zones go to the preset On level with a fade time of 3 seconds (if all assigned zones are currently off). The 3-second fade time cannot be adjusted.

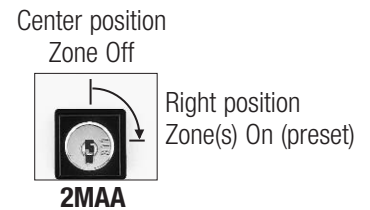
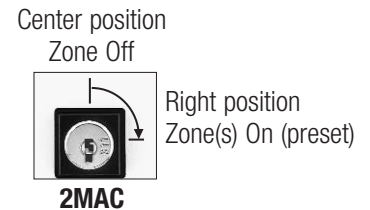
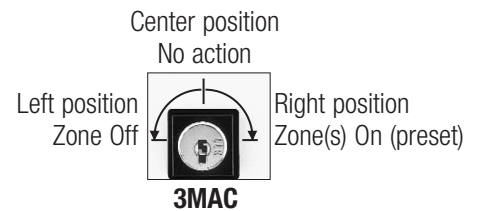
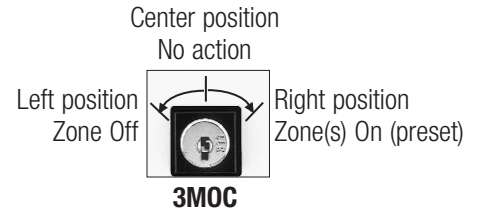
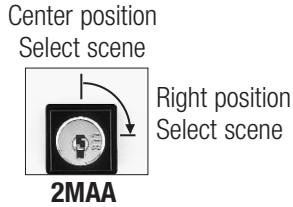
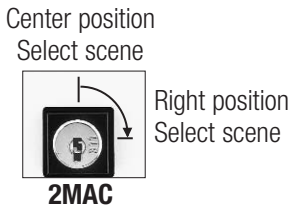
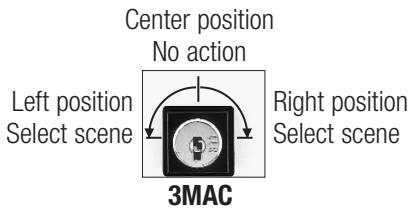
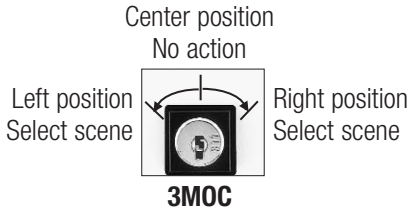

<p>Job Name:</p> <p>Job Number:</p>	<p>Model Numbers:</p>
--	-----------------------

**QSWS2 Keyswitch Functions (continued)**

**Fine Tune Zones:** Raises and lowers the assigned zone(s).

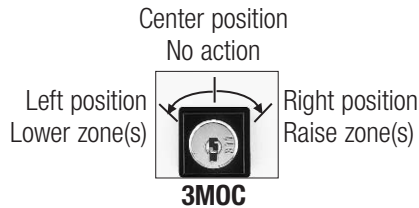

**Timeclock Enable/Disable:** Enables and disables the astronomic timeclock.

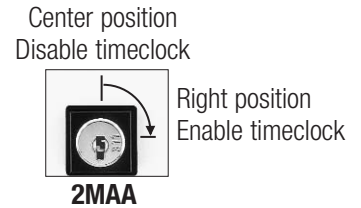
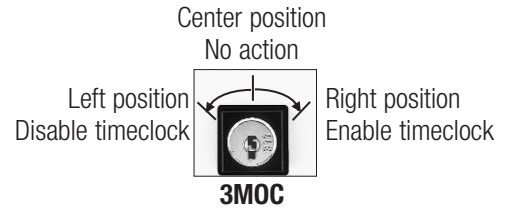

**Sequence Start/Stop:** Starts and stops sequencing of Scenes 1 through 4, or Scenes 5 through 16.

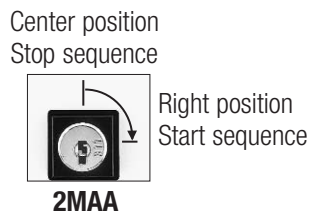
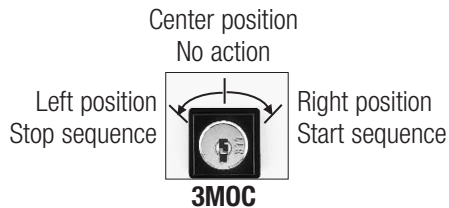

**Afterhours Start/Stop:** Starts and stops afterhours mode (automatically turns off lights when no buttons are pushed for a specified time).

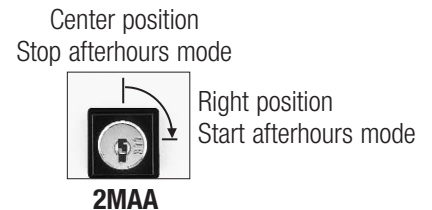
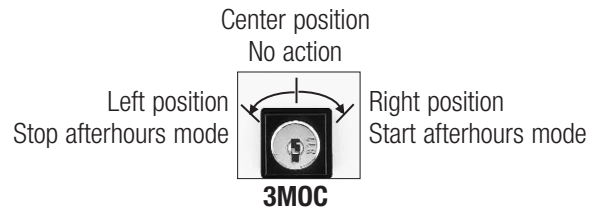

<p>Job Name:</p> <p>Job Number:</p>	<p>Model Numbers:</p>
--	-----------------------



**QSW2 Keyswitch Functions**  
(continued)

**Panic Enable/Disable:** Starts panic mode (sends all assigned zones immediately to scene 16, and locks out all button presses on all connected devices).

**Shade Raise/Lower:** Raises and Lowers assigned shade(s).

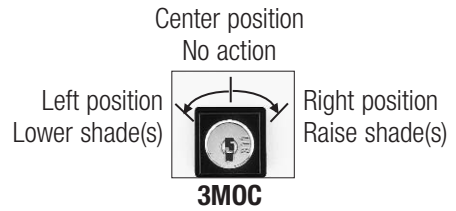
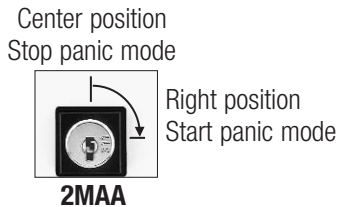
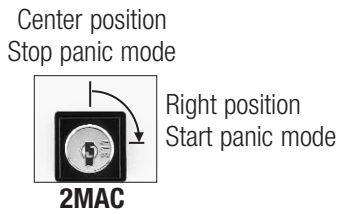
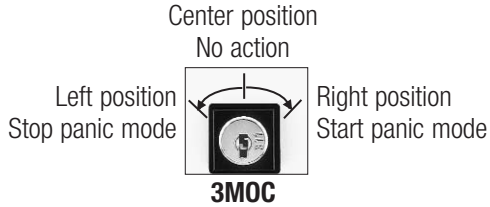

**Sensor Enable/Disable:** Enables and disables either occupancy or daylight sensors.

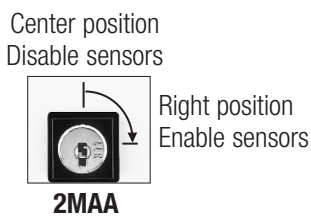
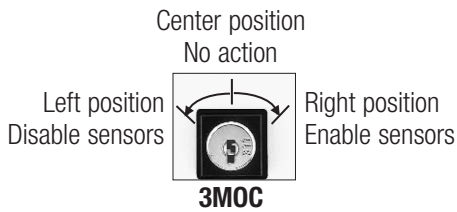

<p>Job Name:</p> <p>Job Number:</p>	<p>Model Numbers:</p>
--	-----------------------