

QS Link Power Supply

The STEP-PS QS link power supply provides up to 22 Power Draw Units (PDUs) on a QS link. The STEP-PS powers additional compatible accessories and devices, allowing them to be added to a QS system.

Specifications

Input Power

- Nominal input voltage: 100–240 V~
- Frequency: 50/60 Hz
- Current consumption, fully loaded:
approx. 0.8 A (230 V~)
approx. 1.3 A (120 V~)

Power Supply Output

- Nominal output voltage and tolerance:
24 V== / ±1%, 22 Power Draw Units*
- Setting range of output voltage: 22.5–25.0 V==;
at time of shipment, the output voltage is 24 V==

* Power supply is rated to provide a maximum of 22 Power Draw Units to devices on the QS Link. Use above this maximum will reduce the lifetime of the supply and void all Lutron® warranties.

Note: This power supply is **NOT** rated for use with motorized shades/window treatments.

Environment

- Ambient temperature operation: -25 to +70 °C (-13 to +158 °F)
(> 55 °C / 131 °F Derating 2.5% / K or 3.5% / F)
- Ambient temperature storage: -40 to +85 °C (-40 to +185 °F)
- Humidity at +25 °C (77 °F), no condensation: ≤ 95%



STEP-PS24DC/3.8-CPN5550
(STEP-PS/1AC/24DC/3.8/C2LPS-CPN5550)

Standards

- Electrical Safety: IEC60950 / VDE 0805, UL/cUL Recognized UL 60950
- Safety Transformer: EN61558-2-17
- Electronic equipment for electrical power installations: EN 50178 / VDE 0106-101
- Safe isolation: DIN VDE 0100-410 / DIN VDE 0106-101
- Industrial regulating devices: UL/cUL Listed UL 508
- Shipbuilding: GL
- Limitation of main harmonic currents: EN 61000-3-2
- Electromagnetic compatibility CE in conformance with EMC Guidelines: 2004/108/EG ; 2006/95/EG.
 - Immunity to interference: EN 61000-6-2
 - Noise emission: EN 61000-6-3
- Protection Class II
- UL Approvals:
 - UL/cUL Listed UL 508
 - NEC® Class 2 as per UL 1310
 - UL/cUL Listed ANSI/ISA-12.12.01 Class I, Division 2, Groups A, B, C, D

<p>Job Name:</p> <p>Job Number:</p>	<p>Model Numbers:</p>
--	-----------------------

Dimensions

Dimensions shown as: mm (in)

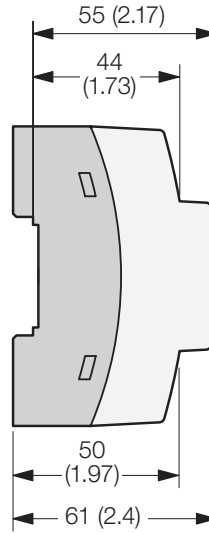
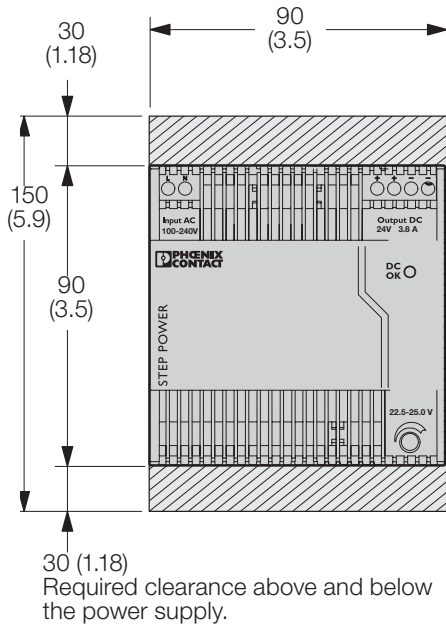

Mounting

- Surface mount using screws, or mount on DIN rail
- Use an IP20 (minimum) rated consumer panel or breaker panel with integrated DIN

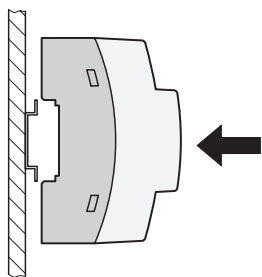

DIN Rail Mounting:
Snap onto DIN rail.
To remove, pull out tabs with screwdrivers and lift off.

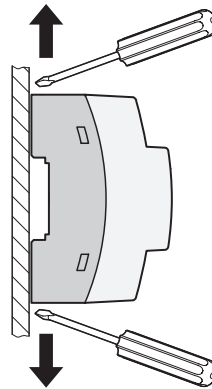
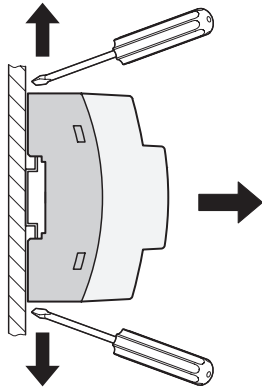

Surface Mounting:
Pull out tabs with screwdrivers.
Screw through tabs to secure.

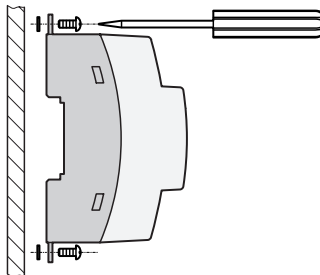

Job Name:	Model Numbers:
Job Number:	

Wiring

- Wire product in accordance with national and local electrical codes
- Each terminal takes one 0.2 to 2.5 mm² (24 to 12 AWG) wire, with 6.5 mm (1/4 in) stripped bare
- Maximum torque: 0.6 to 0.8 N·m (5.0 to 7.0 in·lb)

Hot/live (L) and neutral (N) in from distribution panel

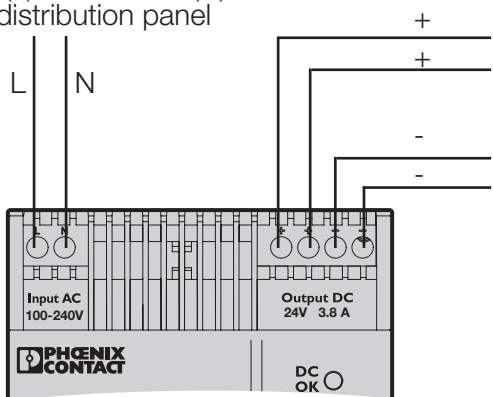

+ + 24 V_{DC} out to terminal 2 of QS devices on the link. Do not connect to terminal 2 of other power sources on the link (see Link Power Distribution diagram)

- - Common out to terminal 1 of all QS devices on the link, including other power sources

Job Name:	Model Numbers:
Job Number:	

QS Link Power Distribution

On the QS link, there are devices that supply power and devices that consume power. Each device has a specific number of Power Draw Units (PDUs) it either supplies or consumes. A Power Group consists of one device that supplies power and one or more devices that consume power; each Power Group may have only one power-supplying device.

Within Power Groups on the QS link, connect all 4 terminals (1, 2, 3, and 4), shown by the letter A in the diagram. Between devices on the QS link that supply power, connect only terminals 1, 3, and 4 (NOT terminal 2), shown by the letter B on the diagram. See **Wiring** section on the previous page for details on wiring the STEP-PS power supply to the QS link.

Example: Power Group Wiring

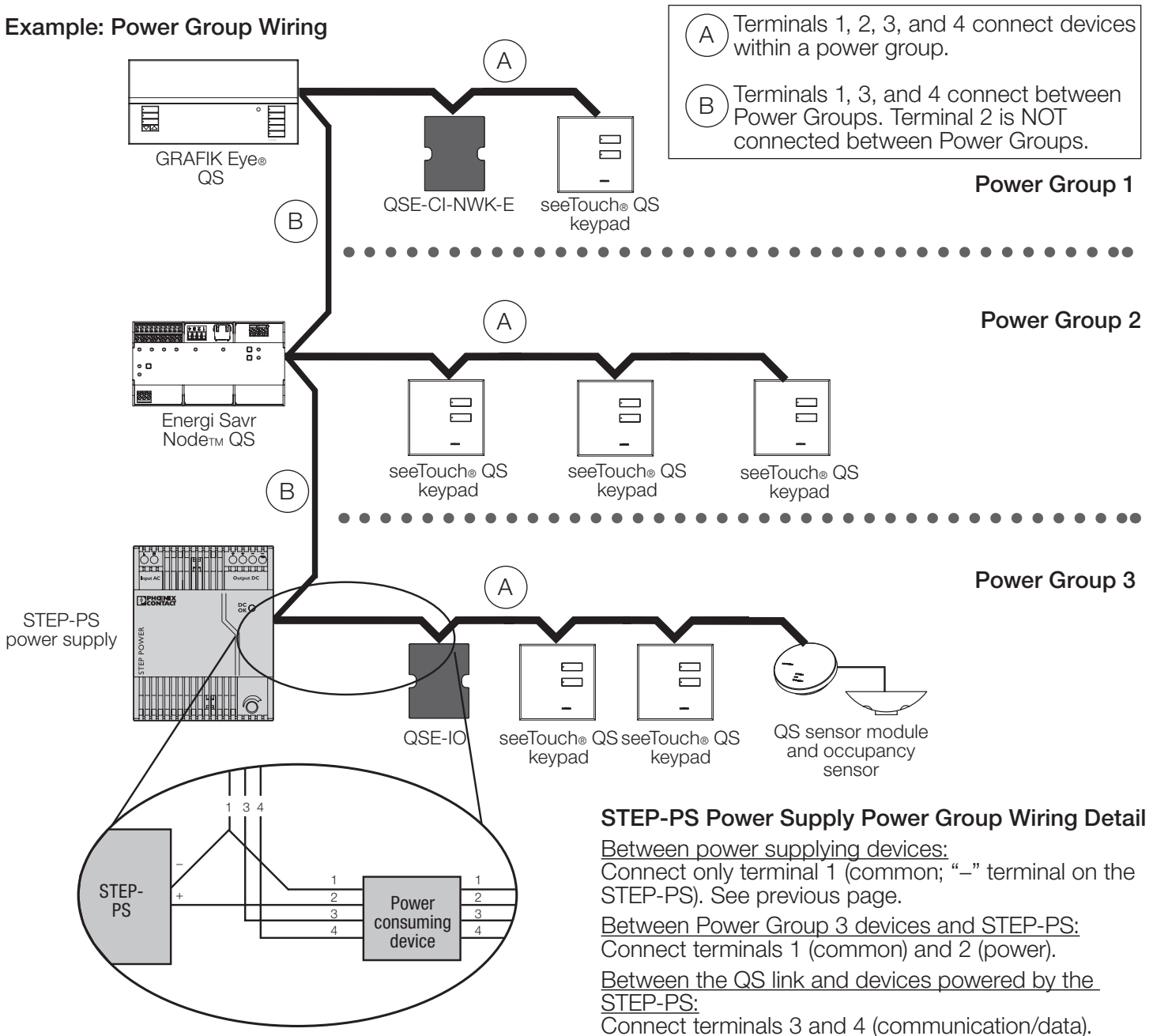

Job Name:	Model Numbers:
Job Number:	