

Compact SE Overview

For designs requiring the energy savings and aesthetic appeal of dimmed T4 compact fluorescent or T5 twin-tube lamps, *Compact SE* dimming ballasts are your solution. The *Compact SE* product family includes ballasts for nearly every type of dimmable compact fluorescent lamp.

Features

- Continuous, flicker-free dimming from 100% to 5%
- Standard 3-wire line-voltage phase-control technology for consistent fixture-to-fixture dimming performance
- Models for 4-pin T4 compact lamps and T5 twin-tube lamps
- Programmed rapid start design will preheat lamp cathodes before applying full arc voltage
- Lamps turn on to any dimmed level without flashing to full brightness
- Low harmonic distortion throughout the entire dimming range maintains power quality
- Frequency of operation ensures that ballast does not interfere with infrared devices operating between 38 and 42 kHz
- Inrush current limiting circuitry eliminate circuit breaker tripping, switch arcing, and relay failure
- End-of-lamp-life protection circuitry ensures safe operation throughout entire lamp life cycle
- Ultra quiet operation
- Protected from miswires of any input power to control lead, or lamp leads to each other or ground
- 100% compatible with all Lutron 3-wire fluorescent controls
- 100% performance tested at factory
- 5-year limited warranty with Lutron field service commissioning (3-year standard warranty) from date of purchase
- Ballasts that dim T4 compact fluorescent lamps are intended for factory installation by OEM fixture manufacturer



Compact SE, case type A

3.00 in W (76 mm) x 1.00 in H (25 mm) x
4.90 in L (124 mm)



Compact SE, case type G

2.38 in W (60 mm) x 1.00 in H (25 mm) x
9.50 in L (241 mm)

Job Name:	Model Numbers:
Job Number:	

Specifications

Performance

- Dimming Range: 100% to 5% measured relative light output (RLO)
- Lamp Starting: programmed rapid start
- Operating Voltage: 120 V~ at 60 Hz, 277 V~ at 60 Hz, or universal voltage (120 V~, 220/240 V~, 277 V~) at 50/60 Hz
- Lamp Current Crest Factor: less than 1.7
- Lamp Flicker: none visible
- Light Output: constant $\pm 2\%$ light output for line voltage variations of $\pm 10\%$
- Lamp Life: average lamp life meets or exceeds rating of lamp manufacturer
- Ballast Factor: greater than .95 for T4 quad or triple tube lamps, and 1.0 for T5 twin-tube lamps
- Power Factor: greater than .95
- Total Harmonic Distortion (THD): less than 10%
- Maximum Inrush Current: 7 A per ballast at 120 V~, 3 A per ballast at 277 V~

Environment

- Minimum Lamp Starting Temperature: 10 °C (50 °F)
- Relative Humidity: maximum 90% non-condensing
- Sound Rating: Inaudible in a 27 dBA ambient
- Maximum Ballast Case Temperature: 75 °C (167 °F)

Standards

- UL Listed (evaluated to the requirements of UL935)
- CSA certified (evaluated to the requirements of C22.2 No. 74)
- Class P thermally protected
- Meets ANSI C82.11 High Frequency Ballast Standard
- Meets FCC Part 18 Non-Consumer for EMI/RFI emissions requirements
- T4 compact fluorescent ballasts are MIL Std. 461E compliant (meets the requirements of CE101, RE101 and RE102)
- Meets ANSI C62.41 Category A surge protection standards to 6 kV
- Manufacturing facilities employ ESD reduction practices that comply with the requirements of ANSI/ESD S20.20
- Lutron Quality Systems registered to ISO 9001

Job Name:	Model Numbers:
Job Number:	

Compact SE Ballast Models

Lamp Type				120 V~		277 V~	
	Lamp Watts	Lamps per ballast	Case Type	Ballast Current (amps)	Compact SE Model Number ¹	Ballast Current (amps)	Compact SE Model Number ¹
T4 4-Pin Quad or Triple Tube  1/2 in (13 mm) diameter	18 W	1	A	0.20	FDB-T418-120-1-S	0.08	FDB-T418-277-1-S
	26 W	1	A	0.30	FDB-T426-120-1-S	0.11	FDB-T426-277-1-S
	32 W	1	A	0.35	FDB-T432-120-1-S	0.13	FDB-T432-277-1-S



Note: For ballasts to control 2 lamp 18, 26, and 32 watt lamps, and for 42 watt lamps, refer to EcoSystem® Compact Fluorescent Specification Submittal.

¹ Mounting studs standard for T4 ballasts. Delete suffix -S in the model number if mounting studs not needed.



Job Name:	Model Numbers:
Job Number:	

Compact SE Ballasts for T5 Twin Tube Lamps

Lamp	Lamps per ballast	Model	Case Size	Input Voltage (~)	Input Current (A)	Input Power (W)	Ballast Factor (BF)	System Lumens (lm)	System Efficacy (lm/W)	Ballast Efficacy Factor	Relative Efficacy (RSE)
FT50 22.5 in (571 mm) 	1	EC3 T550 G U 110	G	277	0.20	55.4	1.0	4000	72	1.81	0.90
				240	0.23	54.0	1.0	4000	72	1.85	0.93
				120	0.45	54.0	1.0	4000	74	1.85	0.93
	2	EC3 T550 G U 210	G	277	0.36	99.7	1.0	8000	80	1.00	1.00
				240	0.42	100.8	1.0	8000	79	0.99	0.99
				120	0.84	100.8	1.0	8000	79	0.99	0.99
FT40 22.5 in (571 mm) 	1	EC3 T540 G U 110	G	277	0.16	44.3	1.0	3100	70	2.26	0.90
				240	0.18	43.2	1.0	3100	72	2.31	0.93
				120	0.36	43.2	1.0	3100	72	2.31	0.93
	2	EC3 T540 G U 210	G	277	0.27	74.8	1.0	6200	83	1.34	1.07
				240	0.32	76.8	1.0	6200	81	1.30	1.04
				120	0.64	76.8	1.0	6200	81	1.30	1.04
	3	EC3 T540 G U 310	G	277	0.40	111.3	1.0	9300	84	0.90	1.08
				240	0.47	112.4	1.0	9300	83	0.89	1.07
				120	0.95	113.2	1.0	9300	82	0.88	1.06
FT39 FT36 15.5 in (394 mm) 	1	EC3 T536 G U 110	G	277	0.14	38.8	1.0	2850	74	2.57	0.93
				240	0.17	39.6	1.0	2850	72	2.53	0.91
				120	0.33	39.6	1.0	2850	72	2.53	0.91
	2	EC3 T536 G U 210	G	277	0.26	72.0	1.0	5700	79	1.39	1.00
				240	0.31	73.2	1.0	5700	78	1.37	0.98
				120	0.61	73.2	1.0	5700	78	1.37	0.98



Job Name:	Model Numbers:
Job Number:	

Case Dimensions

A¹

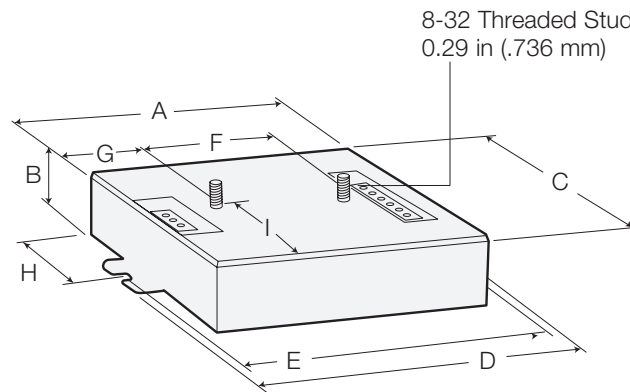

A	4.20 in (107 mm)
B	1.00 in (25 mm)
C	3.00 in (76 mm)
D	4.90 in (124 mm)
E	4.60 in (117 mm)
F	(mounting centers)
G	2.00 in (51 mm)
H	1.08 in (27 mm)
I	1.60 in (41 mm)
I	1.39 in (35 mm)

¹ Mounting studs standard. When ordering, delete suffix -S in the ballast model number if mounting studs not needed.

G

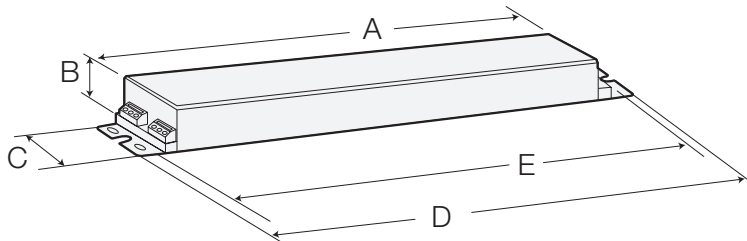

A	7.13 in (181 mm)
B	1.00 in (25 mm)
C	2.38 in (60.5 mm)
D	9.50 in (241 mm)
E	8.91 in (226 mm)
	(slot mounting centers)

If using four hole mount, mounting centers are 9.00 in (229 mm) x 1.06 in (27 mm).

Job Name:

Model Numbers:

Job Number:

Wiring Diagrams

One compact fluorescent lamp

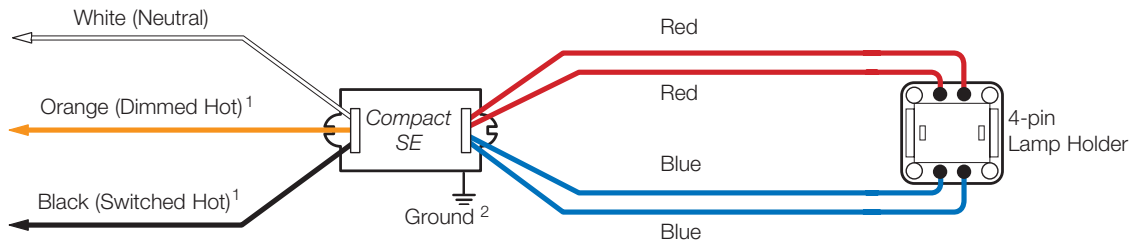

¹ Dimming control wire colors do not necessarily match ballast wire colors (e.g. control “dimmed hot” may be yellow and ballast “dimmed hot” may be orange). Wire colors shown are for Lutron controls and ballasts only.

² Ballast and lighting fixture must be effectively grounded.

Note: For T4 compact lamps, maximum lamp-to-ballast wire length is 3 ft (1 m).

Job Name:	Model Numbers:
Job Number:	

Compact SE Wiring Diagrams

One T5 twin-tube lamp

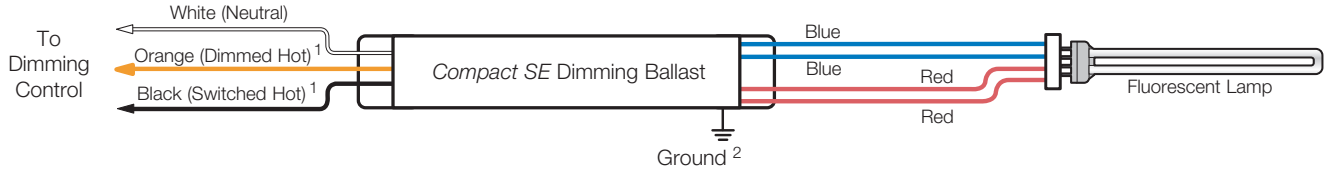

Two T5 twin-tube lamps



Three T5 twin-tube lamps

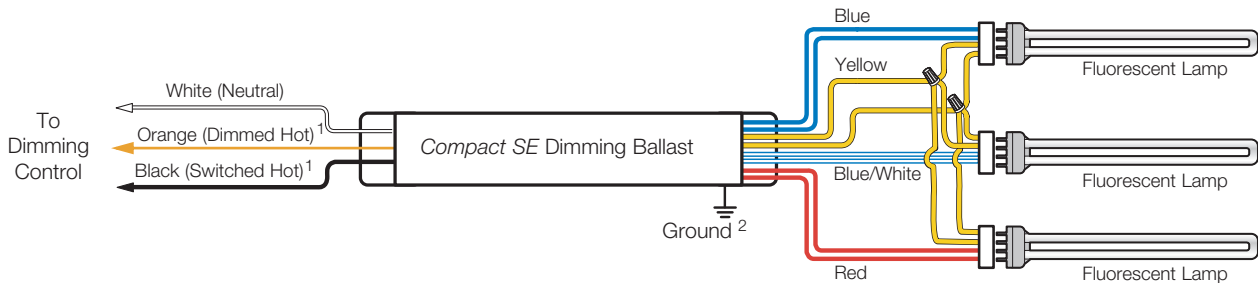

¹ Dimming control wire colors do not necessarily match ballast wire colors (e.g. control 'dimmed hot' may be yellow, and ballast 'dimmed hot' may be orange). Wire colors shown are for Lutron ballasts and controls only.

² Ballast and lighting fixture must be effectively grounded.

Note: For T5 twin-tube lamps, maximum lamp-to-ballast wire length is 3 ft (1 m).

Job Name:	Model Numbers:
Job Number:	

ATTENTION ELECTRICIANS AND CONTRACTORS

Ballast/Socket Leads

Lead lengths from ballast to socket must not exceed 3 ft (1 m) for T4 and T5 twin-tube lamps.

Lamp Sockets

Quality lamp sockets are required to ensure positive lamp-pin to socket contact. T4 compact sockets must be the 4 pin type, and must be used with 4 pin compact lamps. T5 twin-tube lamps require sockets that lock into the lamp base and provide proper lamp support to hold lamp pins in full contact with socket.

Lamp Mounting for T5 Twin-Tube

Many fluorescent lamp sockets are available with mounting slots to vary the height of the lamp away from the grounded metal surface. Use these slots to keep the outside edge of the lamp at least 1/4 in (6.3 mm) away from the grounded metal surface.

Having a fluorescent lamp too close to the grounded metal will make the minimum intensity too low and will reduce lamp life.

Wiring and Grounding

All wiring from the dimming control to *Compact SE* ballasts is line voltage wiring and may be run together in the same conduit.

Ballast and lighting fixture must be effectively grounded. Ballasts must be installed per national and local electrical codes.

Number of Ballasts Per Control

To calculate the maximum number of ballasts allowed per control, divide control's current capacity by individual ballast current. Certain controls allow a specific maximum number of ballasts.

Ballast Operating Temperature

Ballast case temperature must not exceed 167 °F (75 °C) at any point on ballast.

ATTENTION FACILITIES MANAGERS

PERFORMANCE

Lamp Seasoning Requirements

Some fluorescent lamp manufacturers recommend that new fluorescent lamps be operated at full output ("seasoned") before they can be dimmed, to render lamp impurities inert, ensuring proper dimming performance and average rated lamp life. Please contact your lamp manufacturer for seasoning requirements.

SERVICE

Replacement Parts

Use replacement parts with exact Lutron model numbers. Consult Lutron if you have any questions.

Further Information

Ballasts for other lamp types and voltages are available. Consult Lutron's Fluorescent Dimming Systems Selection Guide (P/N 366-002).

For further information, please visit us at <http://www.lutron.com/ballasts> or contact our 24-hour Technical Support Center at 1.800.523.9466.

Job Name:	Model Numbers:
Job Number:	