

myRoom Palladiom QS Thermostat

The myRoom Palladiom QS thermostat is a user interface to an HVAC equipment controller. The large backlit LCD display is easy to see and use, while a built-in Passive Infrared (PIR) sensor detects occupants moving within an area and works with other system components to determine when the space is occupied.

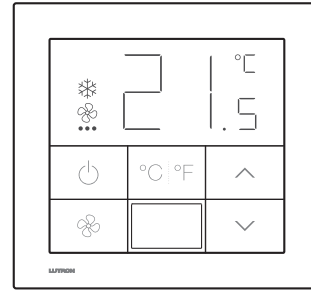

Model Number

MWP-T-OHW-XXX*-A — myRoom Palladiom QS thermostat

Features

- Aesthetically coordinates with Palladiom keypads.
- Compatible with the following HVAC system interfaces:
 - Lutron Fan Coil Unit (FCU) controller (see spec 3691082 at www.lutron.com).
 - 2-pipe or 4-pipe hydronic systems
 - 3-speed or 0–10 V_~ variable fan speed control
 - On/Off or 0–10 V_~ modulating valve control
 - Specific VRV / VRF systems via BACnet® (see page 4)
- Backlit screen and buttons are easy to operate in a dark room. The backlit screen and the buttons will dim to a pre-selected level when not in use.
- Ability to lock out local button control via myRoom Plus system configuration.**
- Built-in vandal-resistant PIR motion sensor with Lutron exclusive XCT detection technology.
- Built-in room temperature sensor.
- Programmable active backlight timeout.
- The FCU controller supports an optional wired remote temperature sensor to allow for flexibility regarding thermostat installation location. When installed, the wired remote temperature sensor is used instead of the internal thermostat sensor.
- IEC SELV/NEC® Class 2 control.
- myRoom Plus and myRoom Prime guestroom control solutions save energy by automatically adjusting the room temperature setpoint based on guest occupancy.
- myRoom Plus can save energy based on room sold/unsold information from the hotel property management system.

* "XXX" in the model number will be 2 or 3 letters that represent color/finish code. See **Colors and Finishes**.

** Available with myRoom Palladiom thermostat version 3.11 or newer.

Job Name:	Model Numbers:
Job Number:	

Specifications

Regulatory Approvals

- Lutron Quality Systems registered to ISO 9001:2015
- Compliant with IEC 60730
- cULus Listed
- NOM Certified
- RoHS Certified

Power Input

- IEC SELV/NEC® Class 2
- Operating voltage: 24–36 V $\overline{=}$ 60 mA

System Communication and Capacity

- IEC SELV/NEC® Class 2 wiring connects Palladiom QS thermostats to other devices on the QS Link.
- A myRoom Plus or a myRoom Prime system can have up to 50 QS devices on the QS link.
- Palladiom QS thermostats each count as 1 device on the QS Link.
- A Palladiom QS thermostat consumes 3 power draw units (PDU) on the QS link. For complete information, see “Power Draw Units on the QS Link” (P/N 369405) at www.lutron.com.

Terminals

- Each terminal accepts up to two 18 AWG (1.0 mm²) wires or one 22 AWG to 12 AWG (0.5 mm² to 2.5 mm²) solid or stranded wires.

Environment

- Ambient operating temperature: 32 °F to 104 °F (0 °C to 40 °C)
- Maximum 90% non-condensing relative humidity
- Indoor use only
- IP20 Rating

Compatibility

- Palladiom QS thermostats are compatible with myRoom Plus and myRoom Prime systems.

Room Temperature Sensor

- Measuring range: 32 °F to 99 °F (0 °C to 37 °C)
- Accuracy
 - At 70 °F: < +/- 1 °F
 - At 25 °C: < +/- 0.5 °C
- 5% to 90% non-condensing, relative humidity

Temperature Setpoint and Display

- The Palladiom QS thermostat is adjustable in 1 °F (0.5 °C) increments.
- The Palladiom QS thermostat displays room temperature in 1 °F (0.5 °C) increments.
- Toggle between Fahrenheit and Celsius temperature units with a button press or Lutron Integration Protocol command.

Continued on the next page...

<p>Job Name:</p> <p>Job Number:</p>	<p>Model Numbers:</p>
--------------------------------------------	-----------------------

Specifications *(continued)*

Wallbox

- Requires a 2.75 in x 2.75 in (70 mm x 70 mm) metal conduit box with a minimum depth of 1.38 in (35 mm).
 - Single wallbox: Lutron model number EBB-1-SQ
 - Pack of 15 wallboxes: Lutron model number EBB-15-SQ
- If the wallbox has top or bottom mounting tabs, bend them back before installing the adapter.
- If running conduit to the wallbox, use a low-profile conduit connector with a maximum height of 0.125 in (3 mm).

Mounting

- Mount on a clean, dry, interior wall.
- Mount approximately 4 ft to 5 ft (1.2 m to 1.5 m) above the floor. Follow all local and national codes.
- Mount on a wall without pipes, chimneys, or ducts.
- Mount on a wall with good visibility and control access.
- Do not mount on an exterior wall, close to a window, next to a door, or areas with drafts.
- Do not mount in direct airflow from supply and return registers/grilles.
- Do not expose to water (e.g., drips or splashes) or mount in a damp area.
- Do not mount within 4 ft (1.2 m) of heating sources (e.g., direct sunlight, light bulbs, etc.).
- Do not mount in areas with poor circulation (e.g., niches, alcoves, behind curtains, or behind doors).
- Do not mount within 0.75 in (19 mm) of Palladiom keypads, receptacles, or accessories.

Job Name: Job Number:	Model Numbers:
--------------------------------------------	-----------------------

HVAC via BACnet System Diagram

The myRoom Palladiom thermostat is able to interface with HVAC systems via BACnet in a myRoom Plus system.*

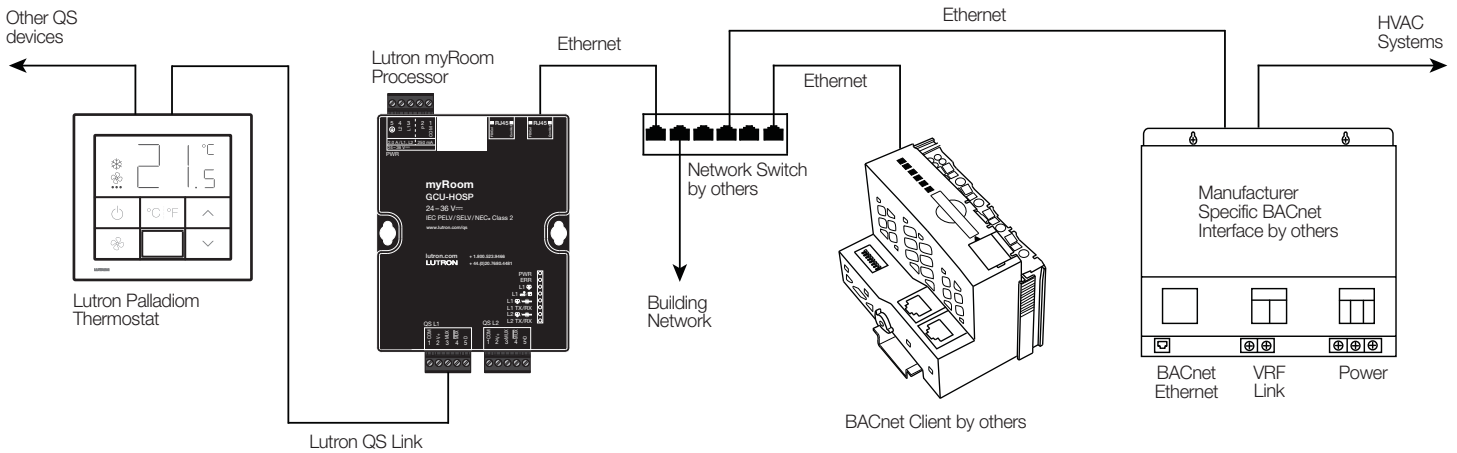

There are several requirements for interfacing to a HVAC system via BACnet that must be met in order to achieve optimal performance. Lutron strongly recommends reviewing these requirements with the HVAC manufacturer, the HVAC contractor, the BACnet integrator, the mechanical, electrical, plumbing (MEP) engineer, and the Lutron project manager and/or field service.

1. Single point failures of the BACnet client, network switch, etc. can cause the Palladiom thermostat in all guest rooms to no longer control the associated HVAC system.
2. HVAC system performance (e.g., delays, changeover temperature differential) is dictated by the HVAC system. The Palladiom QS thermostat provides operating mode, fan mode, and setpoint to the system.
3. The current zone temperature must be provided via BACnet by the HVAC system to the Lutron system in order to have it displayed on the Palladiom QS thermostat and in myRoom Vue software. The local Palladiom temperature sensor is disabled. If the thermostat does not receive a temperature via BACnet within 5 minutes of being powered, an E4 error will be displayed.
4. Call status (actively heating/cooling) must be provided via BACnet by the HVAC system in order for:
 - a. The Palladiom thermostat to indicate the status on the display.
 - b. myRoom Vue to be able to provide HVAC status, HVAC energy reporting, and HVAC data logging.
5. Fan status must be provided via BACnet by the HVAC system in order for myRoom Vue to provide HVAC energy reporting and HVAC data logging.
6. The Palladiom QS thermostat supports 1 °F/0.5 °C resolution temperature changes independent of the resolution supported by the HVAC equipment connected via BACnet.

* Available with myRoom Palladiom thermostat version 3.11 or newer.

Continued on the next page...

Job Name: Job Number:	Model Numbers:
--------------------------------------------	-----------------------

HVAC via BACnet System Diagram *(continued)*

7. The myRoom system supports OFF and AUTO operating modes. Other operating modes are NOT supported (e.g., heat, cool).
8. The myRoom system supports either a single setpoint with positive and negative drifts or a heat and cool set-point. When drifts equal 0, single set-point, heat set-point, and cool set-point will be the same. If the HVAC system does not accept identical heat and cool set-points then drifts must be set in the myRoom system such that the heat and cool set-points are spaced greater than the minimum required by the HVAC system.
9. The myRoom system supports LOW, MEDIUM, HIGH, and AUTO fan modes.
10. When the operating mode is OFF, the fan mode will always be OFF. When the operating mode is AUTO, the fan mode can never be OFF.
11. The temperature scale (°C/°F) displayed on the Palladiom QS thermostat can be changed locally at the thermostat. It cannot be changed via BACnet.
12. If the BACnet system loses communication with the Palladiom QS thermostat, the HVAC system must have its own method to maintain temperature.
13. myRoom Vue will not show the HVAC system alerts and alarms when the HVAC system is connected via BACnet.

For a complete list of available BACnet objects, see **BACnet PIC Statement for myRoom Virtual Devices** (P/N 3691087) at www.lutron.com.

Job Name:	Model Numbers:
Job Number:	

Fan Coil Unit System Diagram

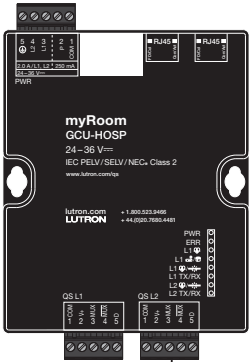

Processor GCU-HOSP

myRoom Plus:
Processor (GCU-HOSP) installed permanently.

myRoom Prime:
Processor (GCU-HOSP) connected temporarily for programming only. See the "myRoom Prime Programming Kit" spec submittal (P/N 369961) at www.lutron.com for more information.

QS Link

To Other QS Devices

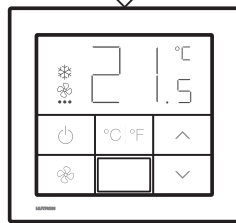

Palladiom QS Thermostat

FCU Controller Communication Link

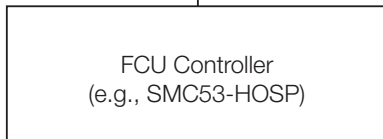

Water Valve and Fan Control Signals

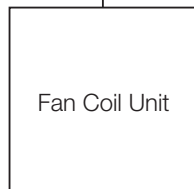

Job Name:	Model Numbers:
Job Number:	

Dimensions

Measurements shown as: in (mm)

Front View

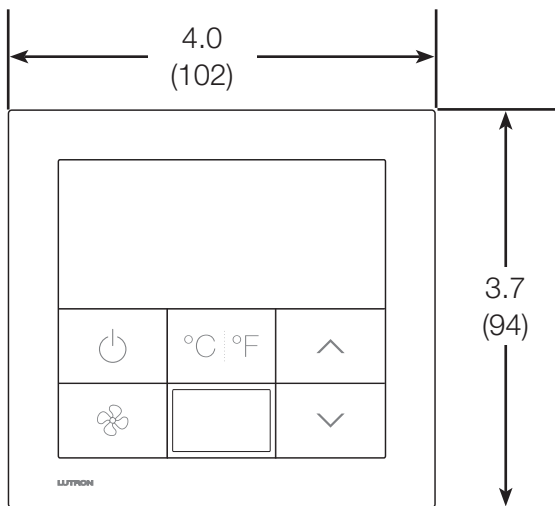

Rear View

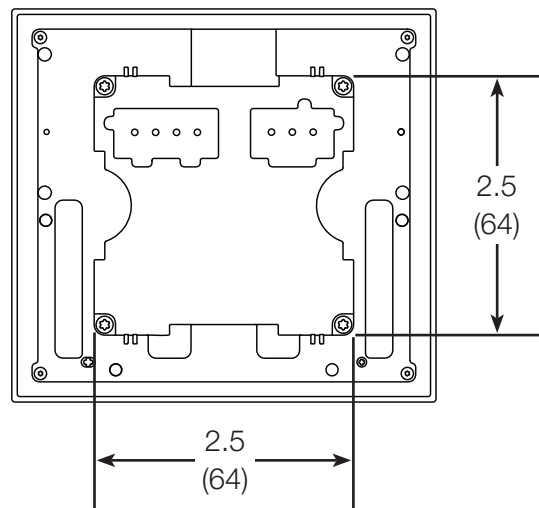

Side View

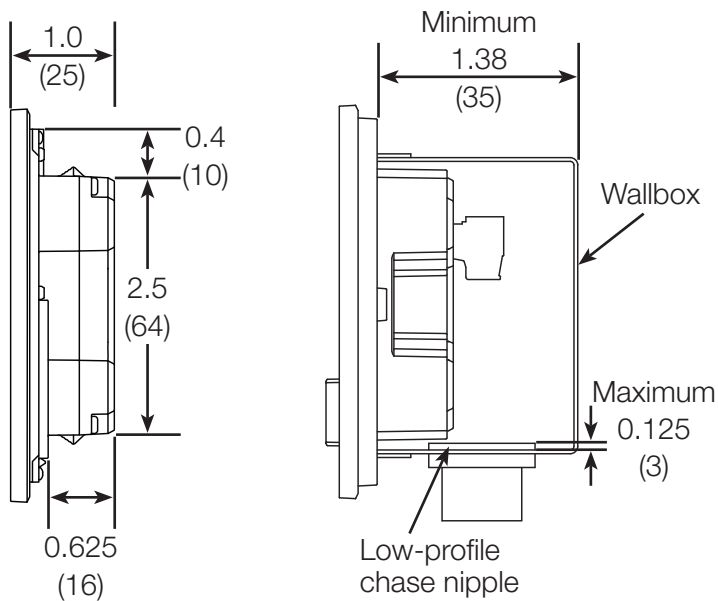

Wallbox (EBB-1-SQ)

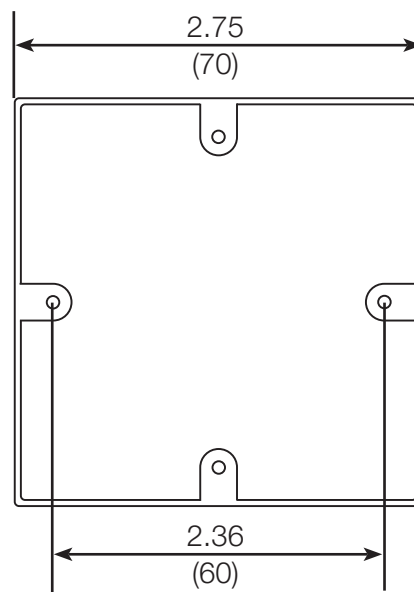

Job Name:	Model Numbers:
Job Number:	

PIR Sensor Placement and Operation

- The ability of the PIR sensor to detect motion requires line-of-sight of room occupants. The PIR sensor must have an unobstructed view of the room.
- Hot objects, moving air currents, and automated shades can affect the performance of the PIR sensor. For best performance, the PIR sensor should be mounted at least 4 ft (1.2 m) away from HVAC vents and light bulbs.
- The performance of the PIR sensor depends on a temperature differential between the ambient room temperature and that of room occupants. Warmer rooms may reduce the ability of the PIR sensor to detect occupants.
- For use as part of the guest presence detection feature to control lights and thermostat based on the occupancy state. PIR sensor is not intended to control lights, thermostat, or shades without using the myRoom Guest Controls solution.
- PIR sensor is not intended to control lights, thermostat, or shades without using guest presence detection.
- 180° sensor field-of-view
- Sensitivity options:
 - High sensitivity (default)
 - Low sensitivity
- Coverage
 - 30 ft x 30 ft (9 m x 9 m)
 - 900 ft² (81 m²)
- Vandal resistant with reinforced metal bar behind lens

Job Name:	Model Numbers:
Job Number:	

PIR Sensor Placement and Operation Diagrams

Occupancy Sensor Coverage

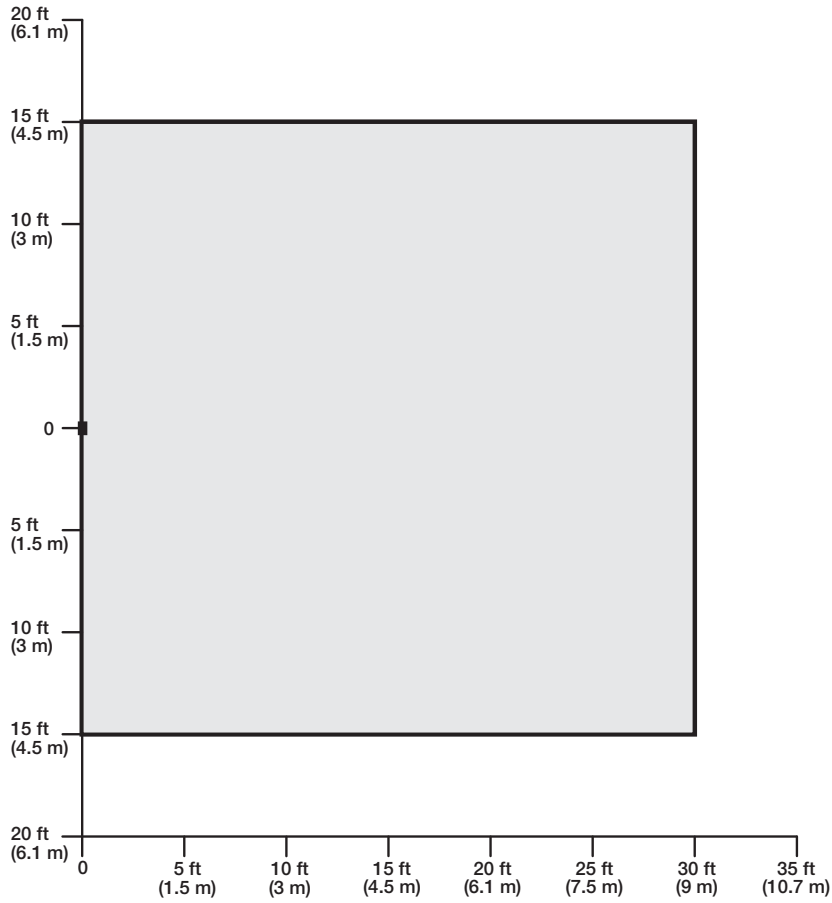

Horizontal Beam Diagram

(for reference only)

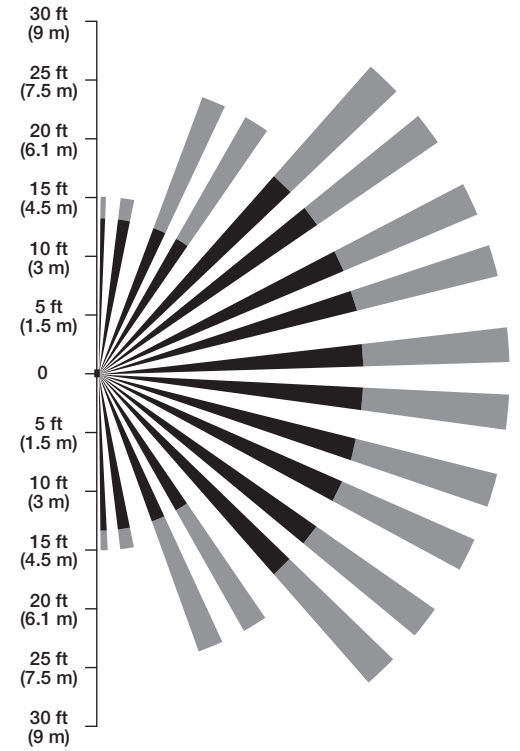

Vertical Beam Diagram

(for reference only)

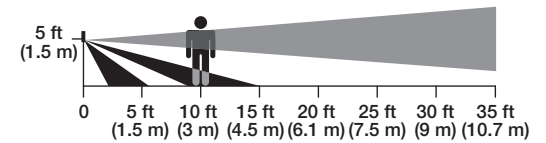

Job Name:	Model Numbers:
Job Number:	

QS Link Wiring

- Use IEC SELV/NEC® Class 2 (24–36 V $\overline{=}$) wiring to connect the thermostat to the QS link for power and communication.
- Connect two 22 AWG (0.5 mm²) shielded, twisted pair wires to terminals 3 and 4. Shielding (drain) of the twisted pair wires must be connected together as shown, but do not connect the shielding to earth/ground or the thermostat and do not allow it to contact the grounded wallbox.
- Connect the appropriate size wires to terminals 1 and 2 for power, according to your link length (see table below).
- Connect Drain/Shield as shown. Do not connect to Ground (Earth) or the thermostat. Connect the bare drain wires and cut off the outside shield.

Note: Use appropriate wire connecting devices as specified by local codes.

Link Wiring less than 500 ft (153 m)

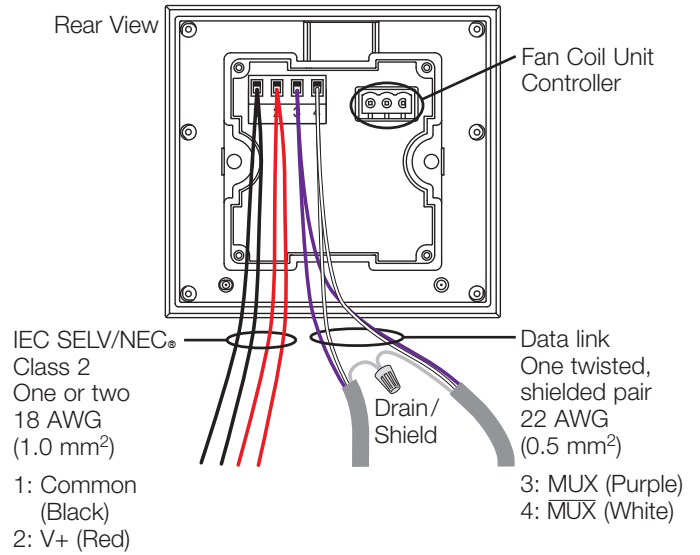

Link Wiring 500 ft to 2000 ft (153 m to 610 m)

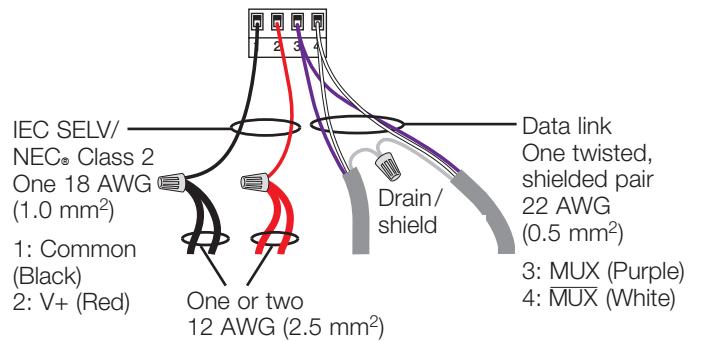

QS Link Wire Sizes (check compatibility in your area)

QS Link Wiring Length	Wire Gauge	Lutron Cable Part Number
Less than 500 ft (153 m)	Power (terminals 1 and 2) 1 pair 18 AWG (1.0 mm ²)	GRX-CBL-346S (non-plenum) GRX-PCBL-346S (plenum)
	Data (terminals 3 and 4) 1 twisted, shielded pair 22 AWG (0.5 mm ²)	
500 ft to 2000 ft (153 m to 610 m)	Power (terminals 1 and 2) 1 pair 12 AWG (4.0 mm ²)	GRX-CBL-46L (non-plenum) GRX-PCBL-46L (plenum)
	Data (terminals 3 and 4) 1 twisted, shielded pair 22 AWG (0.5 mm ²)	

Job Name:	Model Numbers:
Job Number:	

Fan Coil Unit Controller Wiring

- See “Fan Coil Unit Controller” spec submittal (P/N 369962) at www.lutron.com for more information.

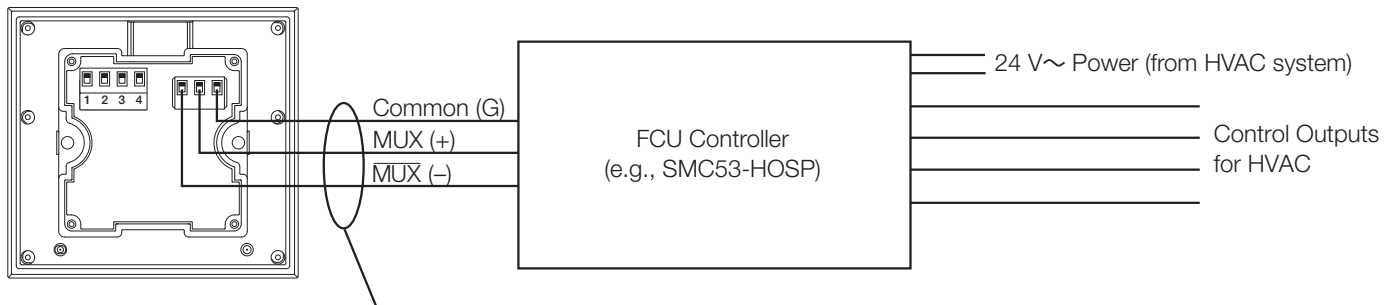

Fan Coil Unit Controller Wiring	Wire Gauge	Lutron Cable Part Number
Up to 500 ft (152 m)	Common: 18 AWG or 22 AWG (1.0 mm ² or 0.5 mm ²) MUX, MUX: 1 twisted, shielded pair 18 AWG or 22 AWG (1.0 mm ² or 0.5 mm ²)	GRX-CBL-346S (non-plenum) GRX-PCBL-346S (plenum)

User Interface

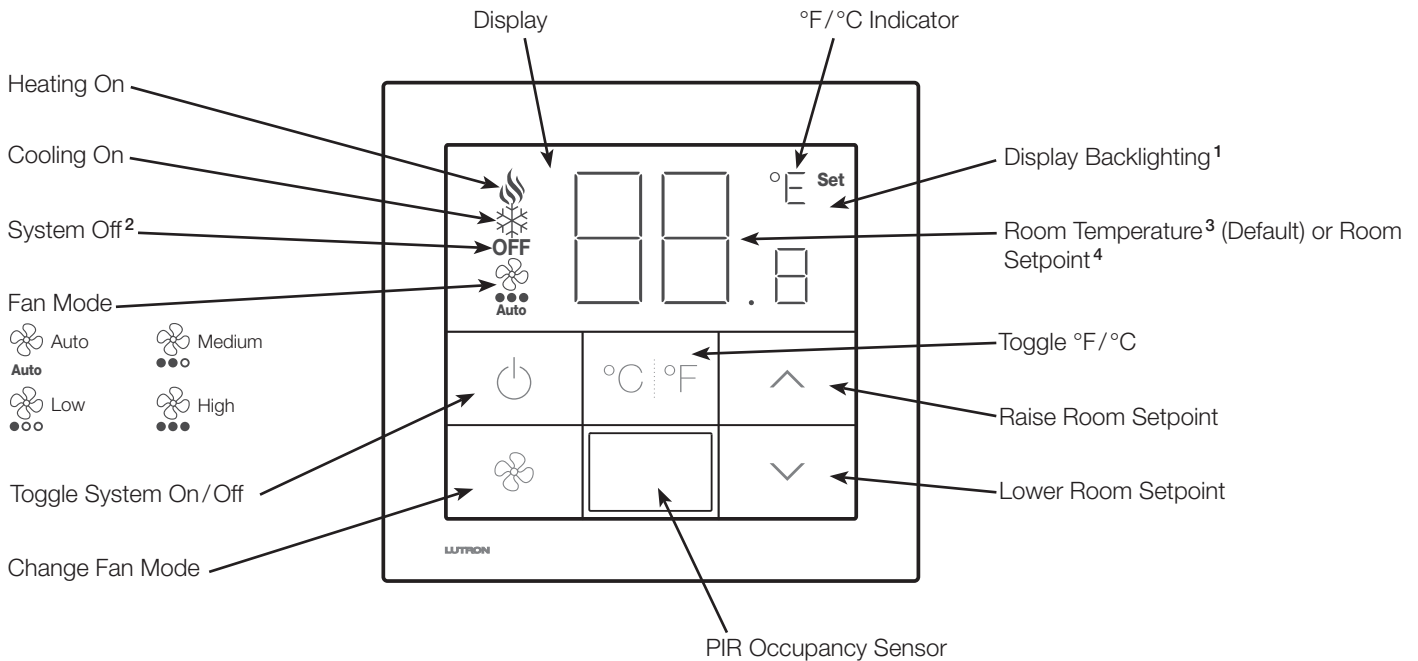

¹ Turns on when any button is pressed. Turns off after 10 seconds of inactivity.

² Room temperature and “OFF” are shown when system is off.

³ Display shows the current room temperature. First raise/lower button press changes the display to show the room setpoint. Further raise/lower button presses adjust the room setpoint.

⁴ Display always shows the room setpoint. The first raise/lower button press activates the LCD backlight. Additional raise/lower button presses adjust the room setpoint.

NOTE: Button backlighting adjustable through system software.

Job Name:	Model Numbers:
Job Number:	

Colors and Finishes







Architectural Matte Finishes

Thermostat

	Almond AL
	Beige BE
	Black BL
	Brown BR
	Gray GR
	Ivory IV
	Light Almond LA
	Sienna SI
	Taupe TP
	White WH



Architectural Metal Finishes

Thermostat

	Bright Brass BB
	Bright Chrome BC
	Bright Nickel BN
	Polished Graphite PG
	Satin Brass SB
	Satin Chrome SC
	Satin Nickel SN

Glass Finish

Thermostat

	Clear Black Glass CBL
	Clear White Glass CWH

- Due to printing limitations, colors and finishes shown cannot be guaranteed to perfectly match actual product colors.
- Color chip keychains are available for more precise color matching:
 - Architectural Matte Finishes: AM-CK-1
 - Architectural Metal Finishes: AMTL-CK-1

 Lutron, Lutron, and Palladiom are trademarks of Lutron Electronics Co., Inc., registered in the U.S. and other countries.

myRoom and XCT are trademarks of Lutron Electronics Co., Inc.

NEC is a registered trademark of National Fire Protection Association, Quincy, Massachusetts.

BACnet is a registered trademark of the American Society of Heating, Refrigerating and Air-Conditioning Engineers, Inc. (ASHRAE).

Job Name:	Model Numbers:
Job Number:	