

Ivalo® Finiré™ LED Recessed Lighting

Downlight/Wall wash Installation

Note: fixture is ready for installation

Leads in junction box are ready for connection. All necessary locations are gasketed. Contractor is responsible for power connection

Fixture installation

1. Install fixture using guide at right- fixture must be supported by structure.(Fig.1)
2. Before completing installation, be certain that trim (when installed) will rest flush with ceiling surface. To adjust trim bracket position:
 - a. Remove upper reflector (2 screws)
 - b. Remove spun aluminum trim housing (keyslots)
 - c. Loosen wing nuts on both sides of yoke to adjust height. (Fig.2)
 - d. Adjust then re-install above
3. Using leads and ground, which are bundled in junction box,make power connections. (See wiring diagrams on back of page)

fig. 1

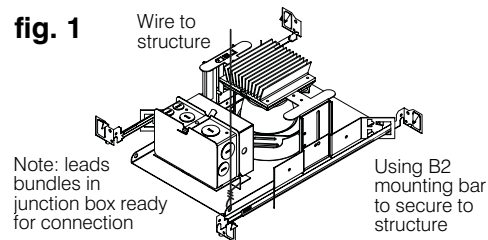

fig. 2

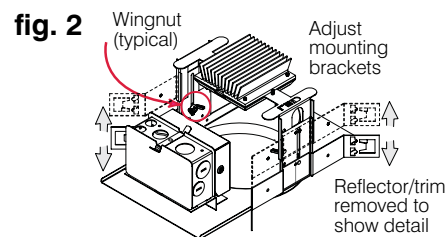

fig. 3

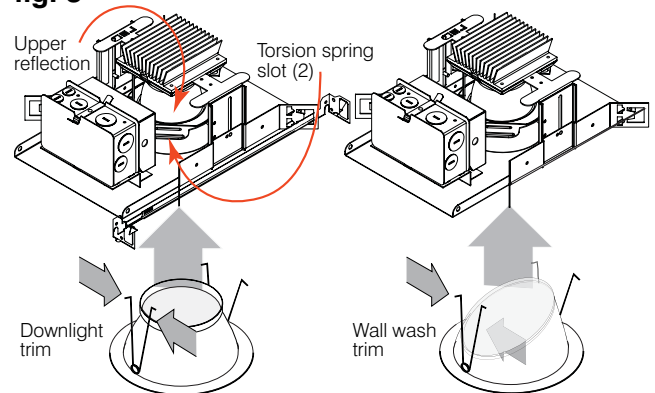
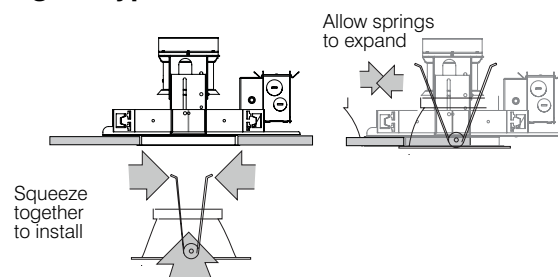

fig. 3- Typical side view



Trim installation

4. Install trim as shown., (Fig.3)
 - a. Compress torsion springs at sides of trim
 - b. Thread through slot in torsion spring bracket
 - c. Allow springs to expand drawing trim up until flange rests on ceiling surface

To replace LED module and /or driver consult factory.

Ivalo® Finiré™ LED Recessed Lighting Downlight/Wall wash Installation

Circuit diagrams for dimming

Wiring Diagram 1

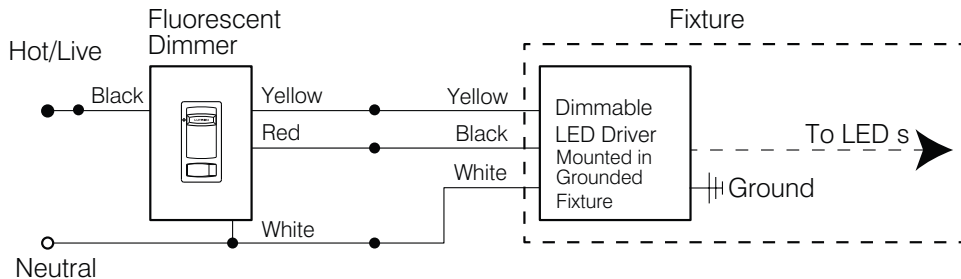

Wiring Diagram 2

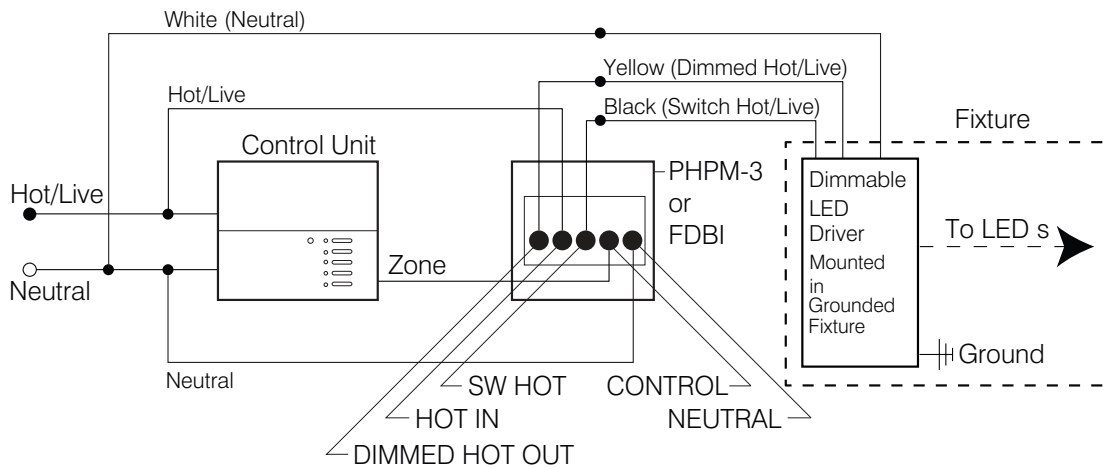

Circuit diagrams for EcoSystem® digital dimming

Wiring Diagram 3

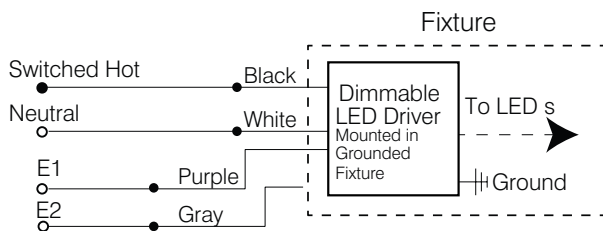

Forward phase control dimming

Wiring Diagram 4

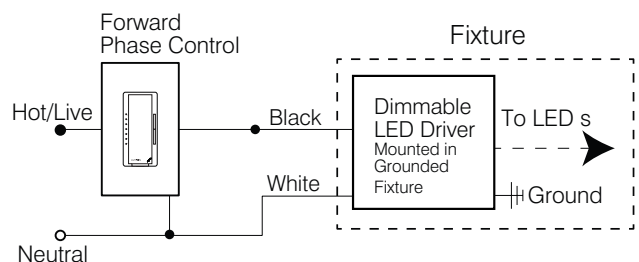

For a list of compatible control please visit www.lutron.com/hilumeled or contact the LED Control Center of Excellence at 1.877.DIM.LED8