



GRAFIK Eye® QS

Design and Application Guide

GRAFIK Eye® QS is a customizable preset lighting control system that allows you to adjust lights and shades for any task. GRAFIK Eye QS helps you save energy, as well as meet the aesthetic, functional, and regulatory needs of any project or space.

- save up to 60% of lighting electricity usage
- increase space flexibility
- increase occupant comfort and productivity
- reduce maintenance costs

GRAFIK Eye QS is now available with reliable Lutron **Clear Connect RF Technology™**, which provides wireless connectivity to shades, sensors, and keypads.

RF capability adds flexibility, saves time and money during the design and installation process, and provides convenient light control from anywhere in the space.

GRAFIK Eye QS is also now available in an EcoSystem® version to **directly control EcoSystem**, EcoSystem H-Series and Hi-lume® 3D digital addressable ballasts, as well as Hi-lume® A-Series LED drivers without requiring additional interfaces.

A significant amount of energy is used for lighting when compared to other building systems.

Controlling your lighting is usually the easiest and most visible way to manage your energy costs while enhancing your space, and can reduce your lighting electricity usage by up to **60%**.

Annual electricity use¹

■ Lighting	38%
■ Cooling	13%
■ Ventilation	13%
■ Refrigeration	12%
■ Other	24%

(Personal computers, space heating, office equipment, water heating, cooking, etc.)

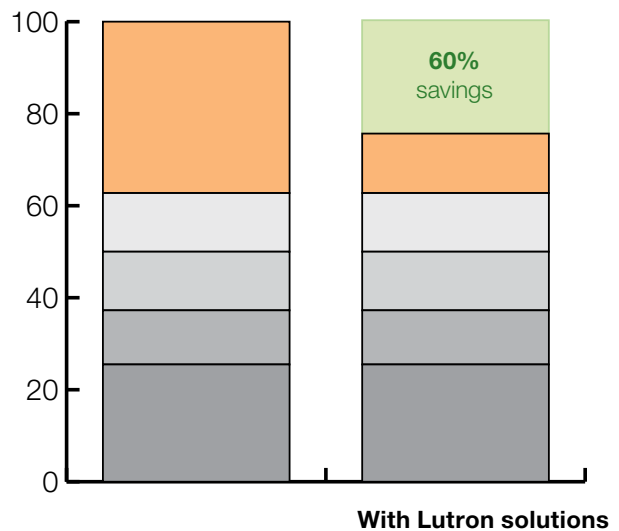

Sources can be found on back cover.

GRAFIK Eye QS design and application guide

- 02 Benefits
- 03 Applications
- 04 Conference room layout
- 06 Basics of preset lighting
- 08 Model comparison
- 09 Key features

- 10 **Steps to follow when designing your system**
- 12 **Step 1:** selecting a GRAFIK Eye QS unit
- 16 **Step 2:** selecting seeTouch® QS keypads
- 20 **Step 3:** selecting shading components
- 24 **Step 4:** selecting energy-saving devices
- 26 **Step 5:** selecting integration devices

- 28 Additional components
- 30 Architectural load dimming connections
- 31 Wires and cables
- 32 Key components system diagram
- 34 Colors and finishes
- 36 Other applications
- 42 Specifications
- 44 The Lutron difference
- 45 Resources

Benefits

Improve comfort and productivity

- Ensure the right visual environment for any activity through simple, preset lighting scenes
- Increase employee productivity by 5-10% by giving them the ability to work in their preferred light level⁸

Save energy and comply with codes

- Reduce lighting energy usage up to 60% with high-end trim, personal control, integral astronomic time clock, occupancy/vacancy and daylight sensing, and after-hours mode
- Cut cooling and heating costs by up to 10% when using with Lutron shades
- Comply with ANSI/ASHRAE/IESNA Standard 90.1-2007, IECC, and California Title 24 energy codes
- Reduce greenhouse gases by eliminating unnecessary energy use

Simplify design and integration

- Connect directly to Sivoia® QS wired or wireless shades, occupancy/vacancy and daylight sensors, keypads, and digital ballasts
- Astronomic timeclock provides event scheduling for convenience and code requirements
- Integrate easily with A/V, HVAC, and other systems through RS232/Ethernet/CCI

Enhance flexibility and expandability

- Digital programming is easily reconfigurable to meet the changing needs of a project or space
- Add components to grow the size and capabilities of the system

Applications

Conference Room

Create a multi-functional space that will allow for quick and easy transitions of the lighting for a scene. Preprogrammed lighting scenes for common room tasks enable intuitive use. (Example on [pgs. 4-5](#). Use as a step-by-step guide to create a GRAFIK Eye® QS system for a conference room.)

Hotel Ballroom

Create the perfect ambiance to match the room's various activities. Add partition sensors to allow for quick and easy transitions of space and lighting with minimal interruptions. (Example on [pg. 36](#).)

Classroom

Enhance the learning environment to improve performance and comfort. Integrate sensors to save energy and reduce maintenance costs. (Example on [pg. 38](#).)

Home Theater

Make your home entertainment experience truly enjoyable by creating lighting scenes that fit with the room's core activities. (Example on [pg. 40](#).)

Other applications:

- Restaurants
- Lecture halls
- Retail floor spaces
- Worship spaces

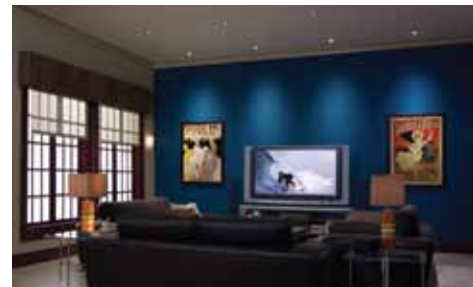

Conference room layout



NEW EcoSystem® H-Series ballasts

cost-effective, digitally addressable 1% dimming ballasts work with wired and wireless sensors and controls—ideal for any application, both retrofit and new construction



NEW Radio Powr Savr™ wireless daylight sensor

wireless sensor gradually dims lights in response to the amount of available daylight



Sivoia® QS Wireless shades

automated window shades move quietly to eliminate glare and reduce heating and cooling costs



NEW Pico™ wireless controls

tabletop, handheld, or wall-mount controls adjust lights or shades from anywhere in the room



Radio Powr Savr™ wireless occupancy and vacancy sensor

wireless sensor provides energy savings by ensuring lights are off when rooms are unoccupied



Lutron solutions do more than just control the light in a space. With the right design strategies, they can save substantial amounts of energy, reduce operating costs, and improve productivity. This design guide will walk through the steps to create a GRAFIK Eye QS system for a conference room space like this one.

Energy-saving strategies

- ▶ High-end trim³ (20% lighting)
- ▶ Occupancy or vacancy sensing⁴ (15% lighting)
- ▶ Daylight harvesting⁵ (15% lighting)
- ▶ Personal dimming control⁶ (10% lighting)
- ▶ Controllable window shades⁷ (10% AC)
- ▶ Timeclock scheduling* (variable)

Potential lighting energy savings

60%

* When scheduling is used without occupancy sensing or vacancy sensing, 15% energy savings can be expected.

Sources can be found on back cover.

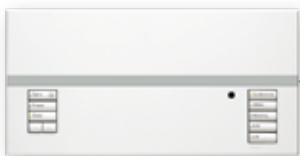

NEW GRAFIK Eye® QS Wireless with EcoSystem customizable preset light control with built-in timeclock allows users to adjust the lights and shades for any task and save energy at the touch of a button



NEW Hi-lume® A-Series LED driver the world's first LED drivers to offer smooth, continuous 1% dimming for virtually any LED fixture—whether it requires constant current or constant voltage





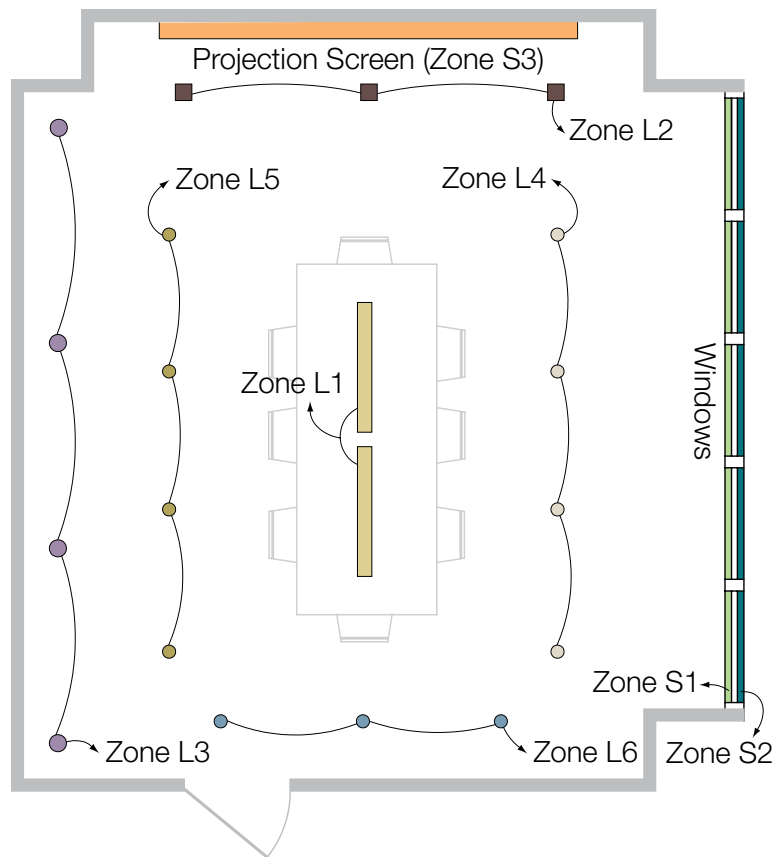

The basics of preset lighting

Zones



A **zone** is a single light, shade, or grouping of lights or shades traditionally controlled by one switch or dimmer. GRAFIK Eye® QS allows you to design each scene by adjusting the lights and shades in a series of zones.



Lighting zones

-  **Zone L6: CFL downlights**
-  **Zone L5: left LED downlights**
-  **Zone L4: right LED downlights**
-  **Zone L3: fluorescent wall wash**
-  **Zone L2: projection ELV downlights**
-  **Zone L1: fluorescent table pendants**

Shading zones

-  **Zone S1: sheer shades**
-  **Zone S2: blackout shades**
-  **Zone S3: projection screen**

Scenes

A **scene** is created by controlling the light level of any single zone or grouping of zones to create the perfect lighting environment for any task or activity. In this example we use a conference room to explain how scenes are created throughout the day. Recall the setting with a touch of a button.



Conference

During a morning conference, open shades to allow daylight in and dim lights to conserve energy.



Video

Blackout shades are lowered to avoid screen glare and lighting levels adjusted to provide enough light for note-taking.



Meeting

The lighting is focused on the conference table and sheer shades are lowered to reduce direct daylight.



A/V

The room is darkened for a late afternoon A/V presentation without sacrificing task lighting on the table.

Model comparison

GRAFIK Eye® QS



Now with Clear Connect RF Technology™, GRAFIK Eye QS enables reliable communication with Lutron® light and shade control products in a space.

- Eliminates the need to run communication wiring to shades, sensors and additional GRAFIK Eye QS units
- Available in 3-, 4-, and 6-zone configurations
- Integral phase control dimmers provide control of incandescent/halogen, magnetic low-voltage, Lutron Tu-Wire® fluorescent dimming ballasts, and non-dimmed lighting loads
- Wired-only options available

GRAFIK Eye QS with EcoSystem®



The GRAFIK Eye QS with EcoSystem combines the flexibility and scalability of the standard model with the additional benefit of an integral EcoSystem bus supply.

- Direct connection to Lutron digital fluorescent ballasts and LED drivers
- Available in 6-, 8-, and 16-zone configurations
- Wired-only options available



Key features

Backlit zone buttons

Raise or lower each group of lights. LEDs indicate current light level for each zone.

Multiple zones

Control up to 16 individual zones.

Information display

Easily read energy savings, lighting levels, and time clock information.

Backlit master override buttons

Temporarily raise and lower light levels of a complete scene.

Create scenes

Backlit engravable buttons for selecting scenes, with or without shades. (changeable in the field)

Control your shades

Backlit engravable shade control buttons. (changeable in the field)

Time clock

Provides scheduling to meet energy code requirements. Includes after-hours mode option.

Infrared remote control

Provides handheld control with a wireless remote.

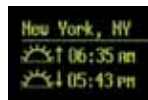

Wireless connections to:

- Sivoia® QS Wireless shades and drapery tracks
- Radio Powr Savr™ occupancy/vacancy sensors
- Pico® wireless controls
- Radio Powr Savr™ wireless daylight sensor

Wired connections to:

- QS interfaces
- seeTouch® QS keypads
- Sivoia QS shades
- Contact closure functions
 - Occupancy sensors
 - Emergency interface
 - Afterhours enable
 - Timeclock enable
 - Lockout
- Wired IR

EcoSystem*:

- Up to 64 digital addressable ballasts
- Daylight sensors
- Occupancy/vacancy sensors

* Features available on GRAFIK Eye QS Wireless with EcoSystem models only.

Step 1 selecting a GRAFIK Eye® QS unit

- A. Identify the number of lighting and shading zones in the space **pg. 13**
- B. Identify the load types in the space **pg. 13**
- C. Build a **STANDARD** GRAFIK Eye QS model number **pg. 14**
- C. Build a **NON-STANDARD** GRAFIK Eye QS model number **pg. 15**

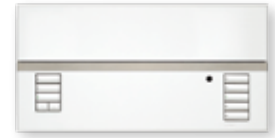

Step 2 selecting seeTouch® QS keypads

- A. Select keypad style and button configurations..... **pg. 16**
- B. Build a seeTouch QS keypad model number **pg. 17**



Step 3 selecting shading components

- A. Select power components for Sivoia® QS **WIRELESS** system **pg. 20**
- A. Select power components for Sivoia QS **WIRED** system **pg. 21**
- B. Select appropriate window treatments **pg. 22**



Step 4 selecting energy-saving devices

- A. Select appropriate occupancy/vacancy sensors **pg. 24**
- B. Select daylight sensors **pg. 25**



Step 5 selecting integration devices

- A. Determine the type of integration needed **pg. 26**



Steps to follow when designing your system

Step 1 selecting a GRAFIK Eye® QS unit

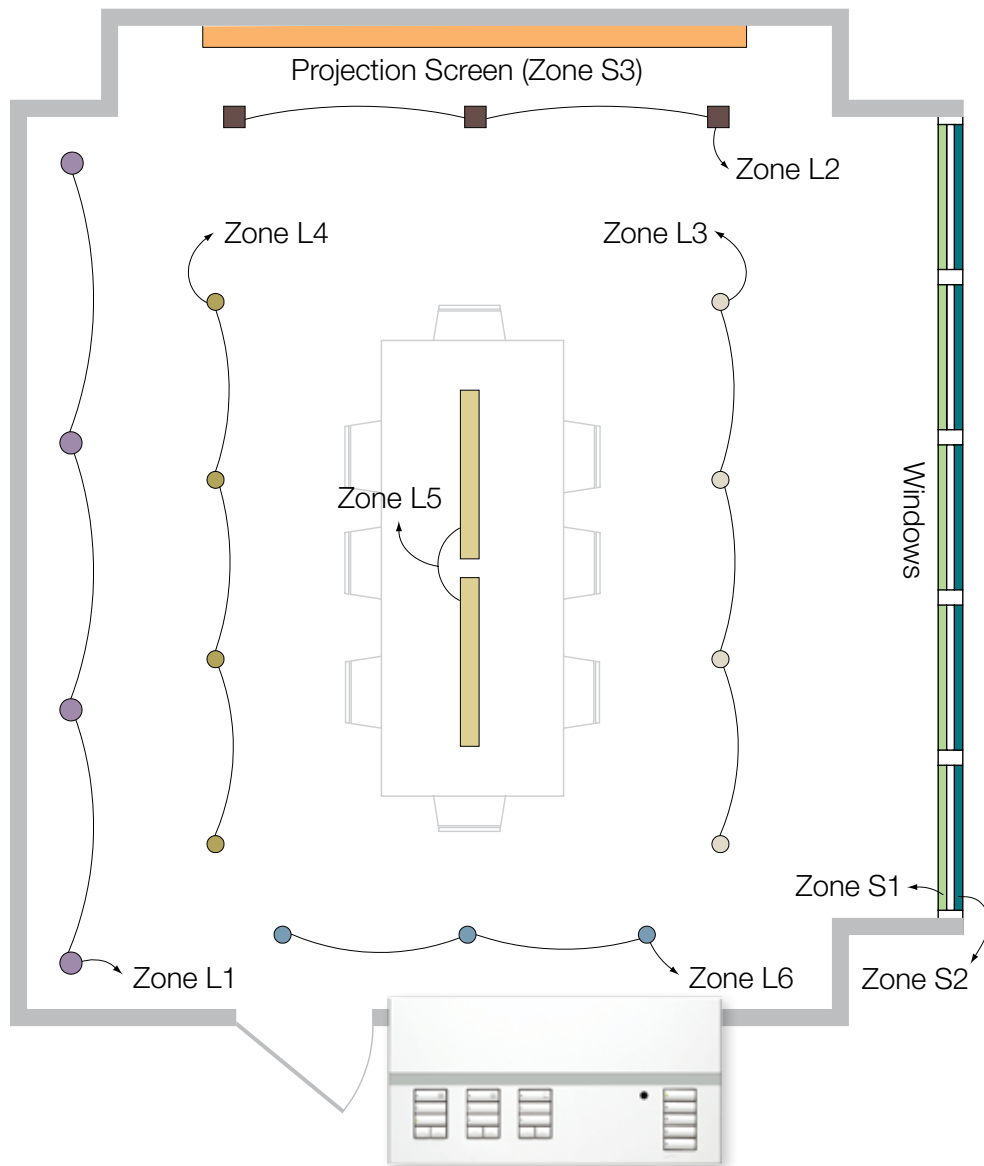

In this example we are using a 6-zone EcoSystem® model with 3 groups of shades.



Interactive GRAFIK Eye QS Design Tool and the design guide worksheet available at lutron.com/grafikeyeqs

A. Identify the number of lighting and shading zones in the space

Rules

- GRAFIK Eye QS is available with 3, 4, or 6 zones of lighting control and up to 3 zones of shades
- GRAFIK Eye QS with EcoSystem is available with 6, 8, or 16 zones of lighting control and up to 3 zones of shades

In this system example:

Conference room

- Zone L1: Wall wash
- Zone L2: Projection downlights
- Zone L3: Right downlights
- Zone L4: Left downlights
- Zone L5: Table pendants
- Zone L6: CFL downlights
- Zone S1: Sheer shades
- Zone S2: Blackout shades
- Zone S3: Projection screen

B. Identify the load types in the space

Rules

- Power modules are required for exceeding zone capacity (800 Watts), and/or control of electronic low-voltage or 0-10V zones, or switching of non-dimmed lighting loads (see [pg. 33](#))
- On an EcoSystem unit, zones 1, 2, and 3 are integral line-voltage dimming zones, which can also be used as EcoSystem zones to control up to 64 ballasts

In this system example:

Phase/digital control zones

- Zone L1: Electronic low-voltage, 4 fixtures, 200W, (power module required)
- Zone L2: Halogen, 3 fixtures, 225W
- Zone L3: Hi-lume® A-Series LED, 4 drivers

Digital control zones

- Zone L4: Hi-lume A-Series LED, 4 drivers
- Zone L5: EcoSystem H-Series, 2 ballasts
- Zone L6: EcoSystem CFL, 3 ballasts

Shade zones

- Zone S1: Sivoia® QS, 5 sheer shades
- Zone S2: Sivoia QS, 5 blackout shades
- Zone S3: Projection screen

Steps to follow when designing your system

Step 1 selecting a GRAFIK Eye® QS unit*

C. Build a **STANDARD** GRAFIK Eye QS model number

Standard GRAFIK Eye QS models come with a base unit with wireless capability and an unengraved white faceplate with either 0 or 1 shade zones. For all other colors, engraving options, and/or units with more than one shade zone, you must order a non-standard model (see [pg. 15](#)).

QSGRJ-**6****E**-**1****T** WH

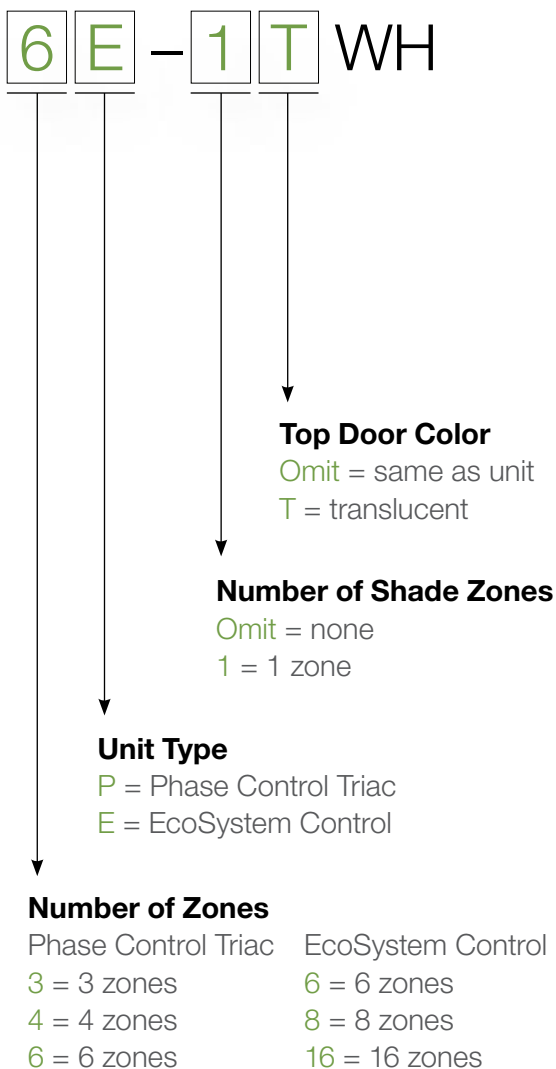

Model numbers

Phase Control Triac

- QSGRJ-3P-WH
- QSGRJ-3P-TWH
- QSGRJ-3P-1WH
- QSGRJ-3P-1TWH
- QSGRJ-4P-WH
- QSGRJ-4P-TWH
- QSGRJ-4P-1WH
- QSGRJ-4P-1TWH
- QSGRJ-6P-WH
- QSGRJ-6P-TWH
- QSGRJ-6P-1WH
- QSGRJ-6P-1TWH

EcoSystem® Control

- QSGRJ-6E-WH
- QSGRJ-6E-TWH
- QSGRJ-6E-1WH
- QSGRJ-6E-1TWH
- QSGRJ-8E-WH
- QSGRJ-8E-TWH
- QSGRJ-8E-1WH
- QSGRJ-8E-1TWH
- QSGRJ-16E-WH
- QSGRJ-16E-TWH
- QSGRJ-16E-1WH
- QSGRJ-16E-1TWH

* Wired (non-RF) units available upon request. Please contact Lutron directly for further details.

C. Build a **NON-STANDARD** GRAFIK Eye QS model number

Rules

For any non-standard units, you must order **BOTH** a base unit and a faceplate kit.

Base unit

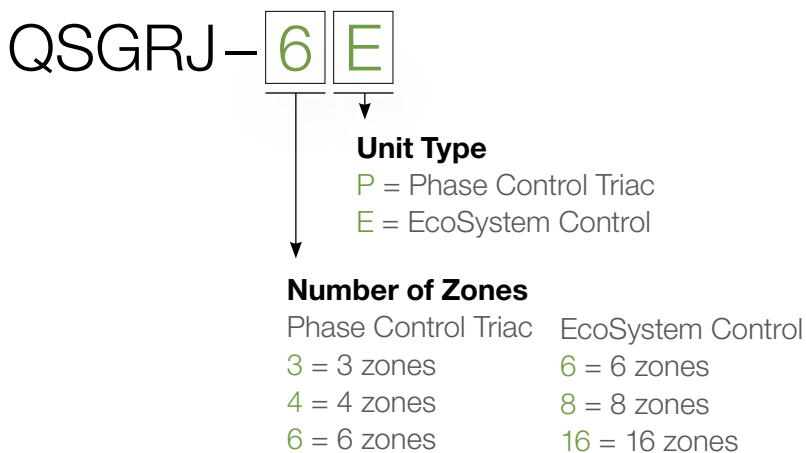

Faceplate kit (includes coordinating stripe and buttons)

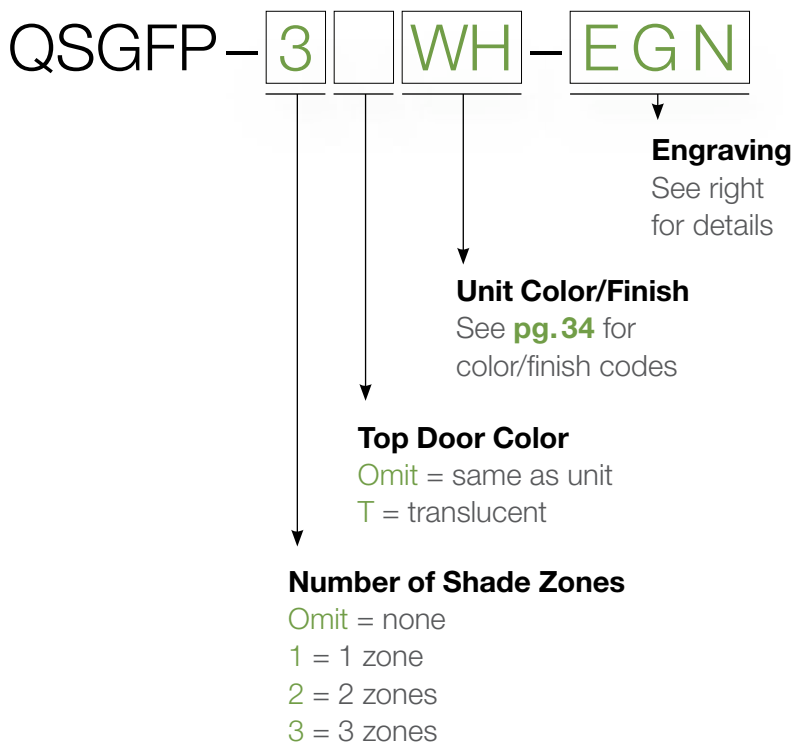

Engraving codes

Omit = unengraved
 (ships with engraving certificate that customer can redeem for engraved replacement buttons at no charge)

EGN = general engraving

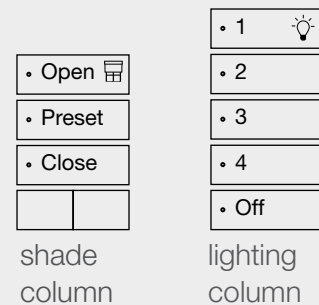

NST = non-standard text engraving. Please visit www.lutron.com/grafikeyeqs for custom engraving forms. Submit completed form with order, and faceplate kit will ship engraved as specified by customer.

Step 2 selecting seeTouch® QS keypads

A. Select keypad style and button configurations



Non-insert style

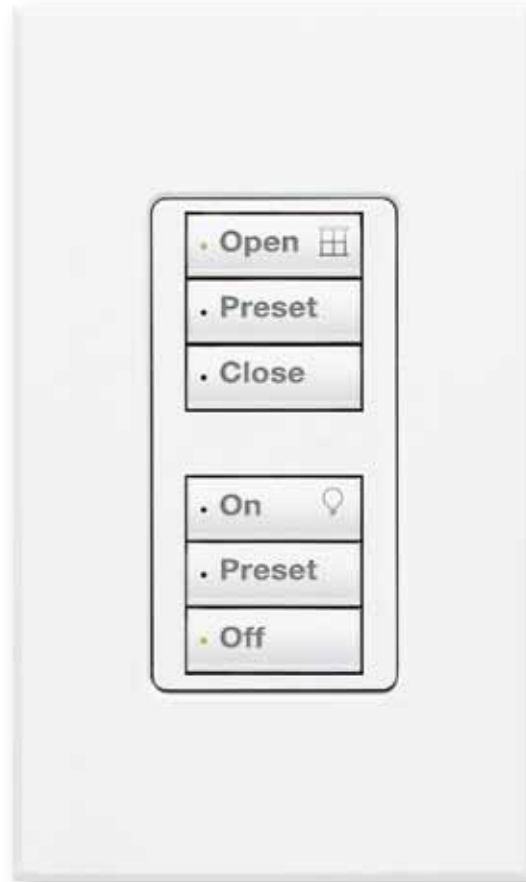

Insert style

seeTouch QS keypads

- 14 models available with 1- to 7-scene preset, zone, partition, or shade control buttons
- Available with or without raise/lower buttons and an IR sensor
- Control shades, lights, or a combination of both
- Each keypad includes two built-in contact closures

Rules

The GRAFIK Eye® QS can power up to 3 keypads.

For additional keypads, a QS link power supply is required. (see [pg. 29](#))



1B
1-button



2B
2-button



3B
3-button



5B
5-button



7B
7-button



2BRL
2-button with
raise/lower



3BRL
3-button with
raise/lower



5BRL
5-button with
raise/lower



2BRLIR
2-button with
IR receiver and
raise/lower



3BRLIR
3-button with
IR receiver and
raise/lower



5BRLIR
5-button with
IR receiver and
raise/lower



1RLD
Dual with 3-button
and 2-button with
raise/lower



2RLD
Dual 2-button
with raise/lower



3BD
Dual 3-button

Steps to follow when designing your system

Step 2 selecting seeTouch® QS keypads

B. Build a seeTouch QS keypad model number

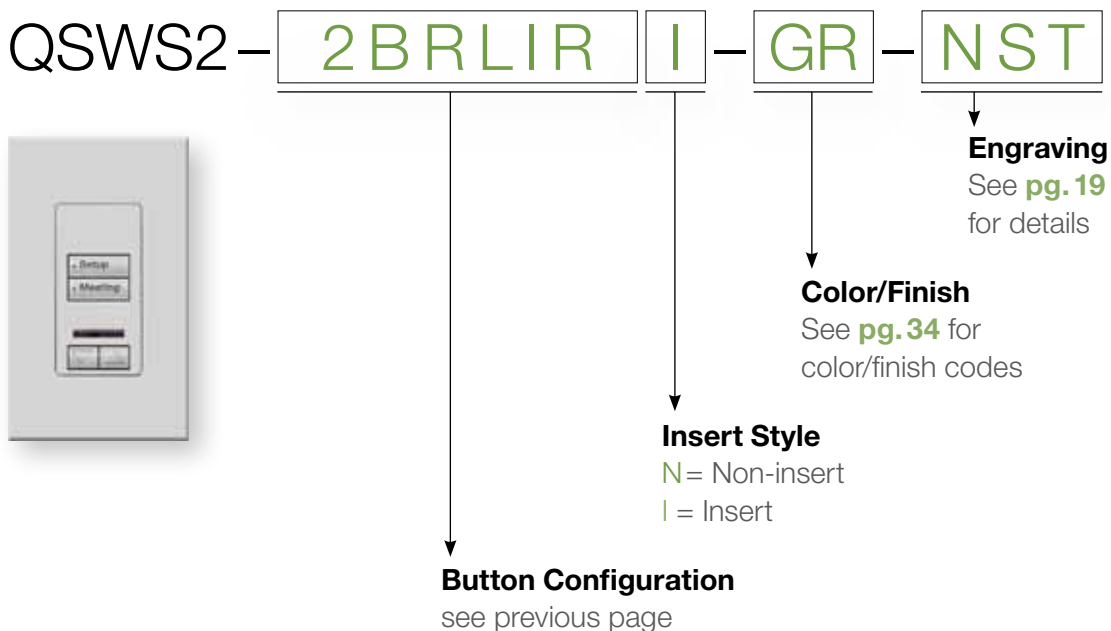
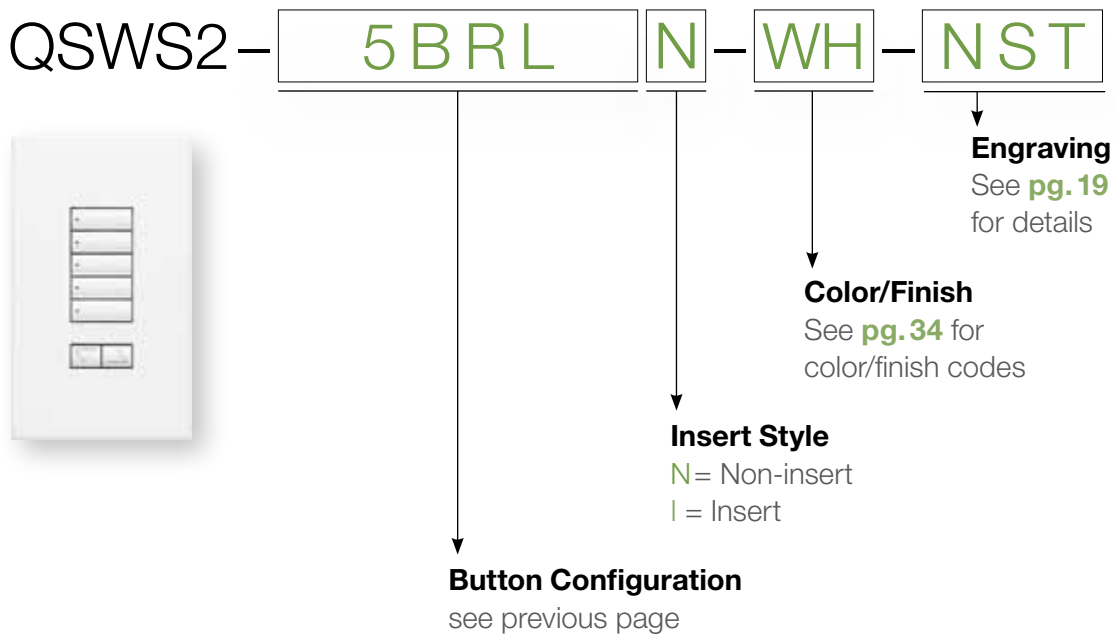

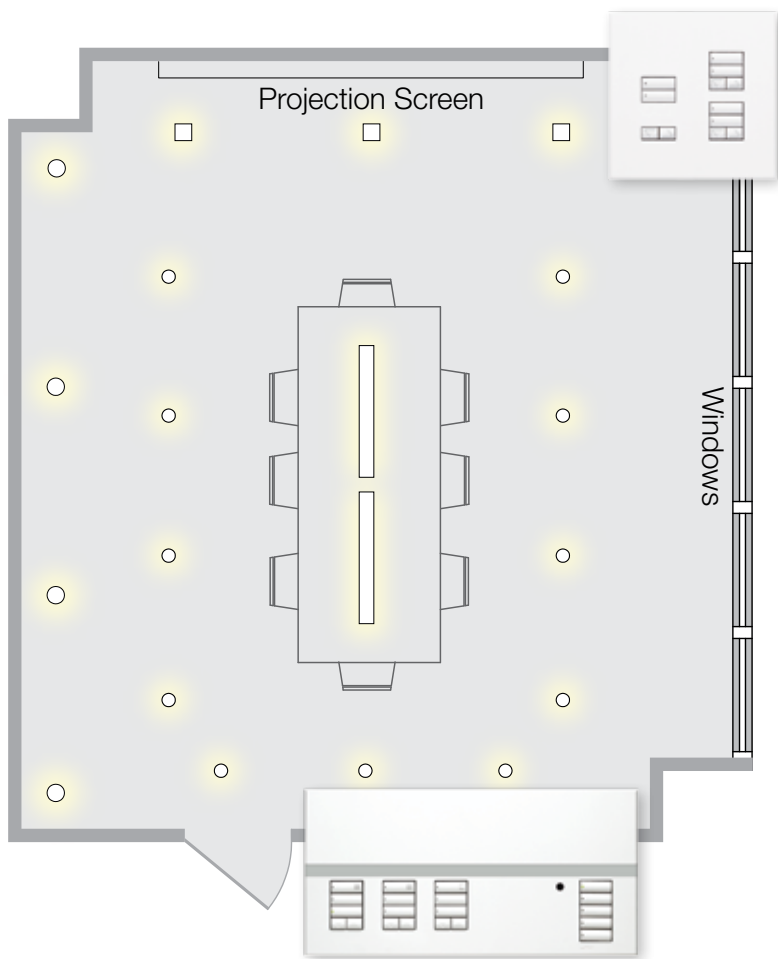

Engraving codes

Omit = unengraved (ships with engraving certificate that customer can redeem for engraved replacement buttons at no charge)

EGN = general engraving

NST = non-standard text engraving. Please visit www.lutron.com/grafikeyeqs for custom engraving forms. Submit completed form with order, and unit will ship engraved as specified by customer.

Steps to follow when designing your system

Step 3 selecting shading components

A. Select power components for Sivoia® QS **WIRELESS** system



Sivoia QS wireless panel power supply

(powers up to 10 roller shades)

QSPSY-P1-10-60



QS link wireless power supply

(powers 1 roller shade)

QSPS-P1-1-50

Powering shades on a **WIRELESS** system example (11 shades)

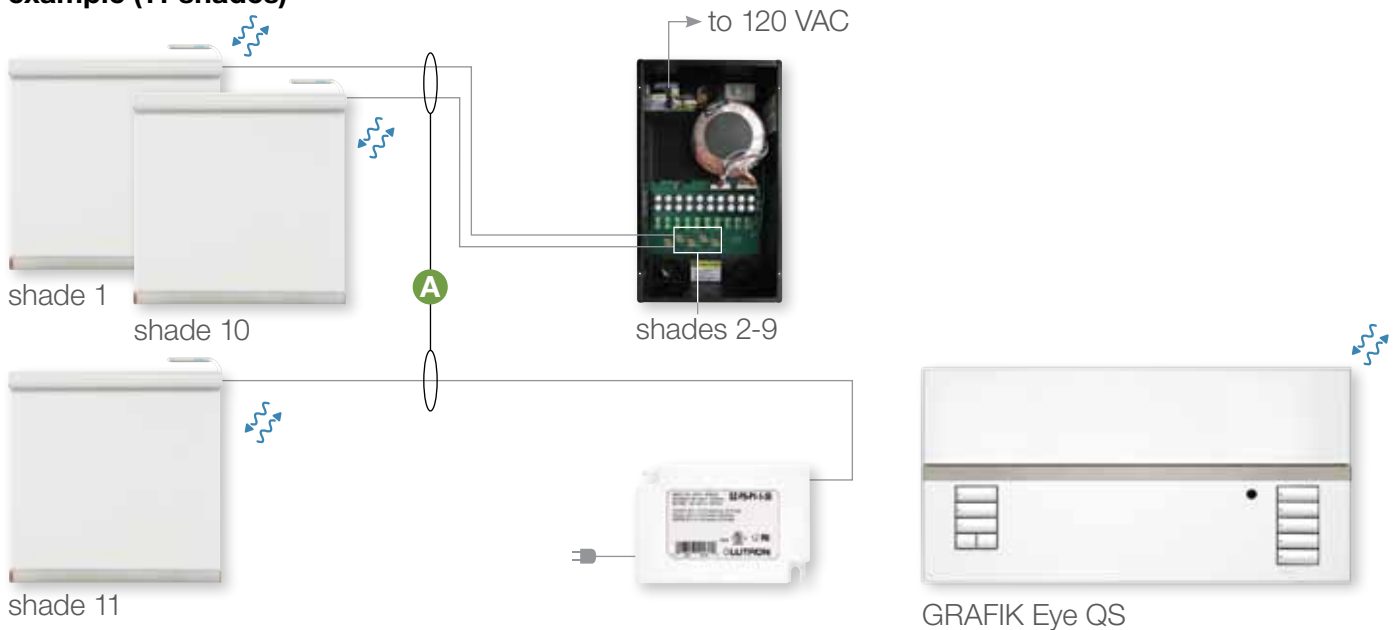

Shade zones are programmed through wireless communication with the GRAFIK Eye® QS.

A Power (2-conductor)

A. Select power components for Sivoia QS **WIRED** system



Sivoia QS smart panel power supply
 (powers up to 10 roller shades)
 QSPS-P1-10-60



QS link power supply
 (powers 1 roller shade)
 QSPS-P1-1-50

Powering shades on a WIRED system example (11 shades)

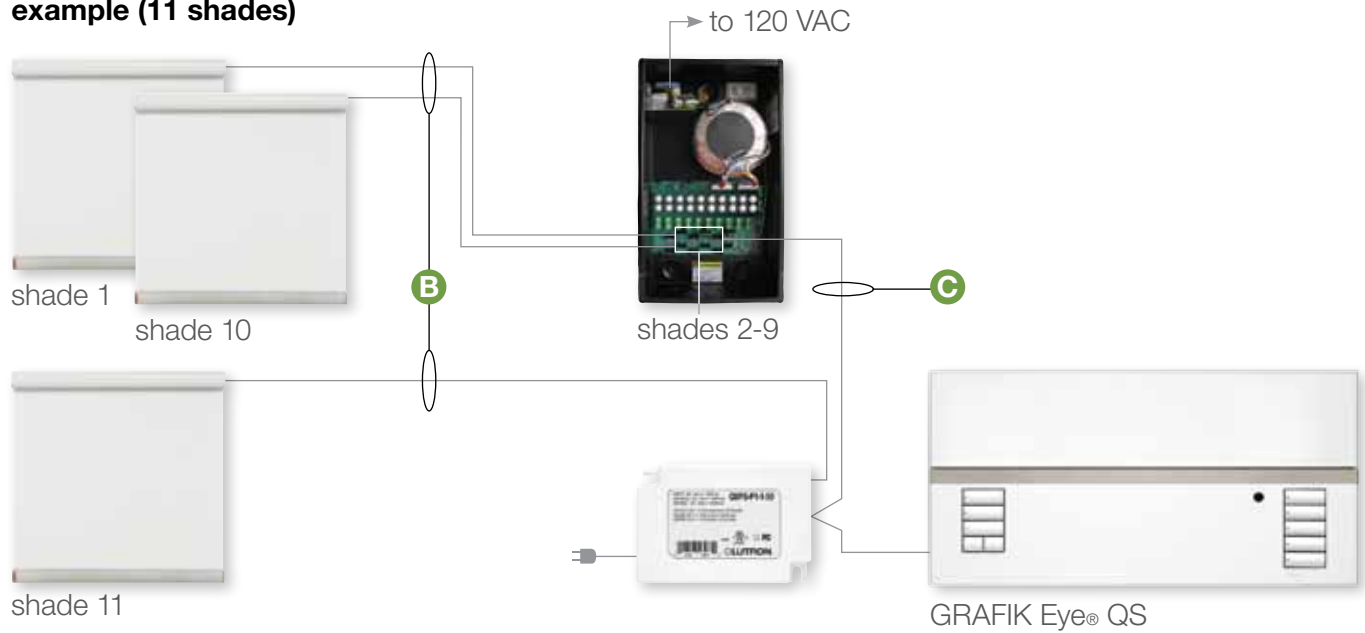

Shade zones are programmed through the GRAFIK Eye QS without the need for rewiring.

- B** Power and communications (4-conductor)
- C** Communications (3-conductor)

Step 3 selecting shading components

B. Select appropriate window treatments

Roller shade

Sivoia® QS roller shades are the ideal solution for ultra-quiet precision control of daylight. Shades start, move, and stop in unison, maintaining perfect alignment with each other (within .125 in. [3.17mm]).

Select from the following fabric categories for your application:

Sheer: Block glare and heat gain while preserving the view.

Dim-out: Let light in while limiting the view to shapes and shadows.

Blackout: Block all light from passing through the material.
Combine with side channels and sill angle for complete light seal.

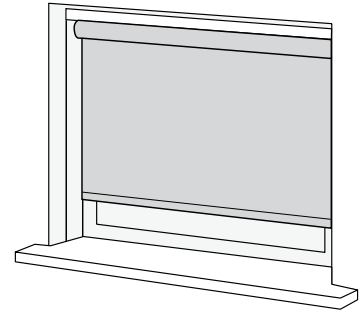

Drapery track

Sivoia QS drapery track systems are the perfect solution for controlling draperies that respond to the touch of a button. Operate pinch pleat or ripplefold draperies for quiet, elegant control of daylight.

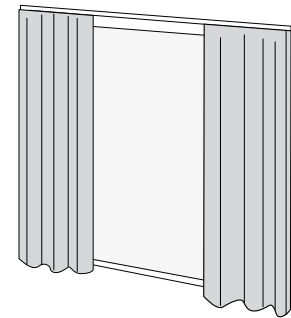

Skylight shade

Reliably control daylight through skylights to enhance the visual environment and save energy by reducing solar heat gain.

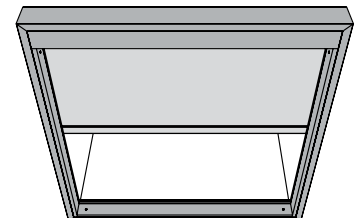

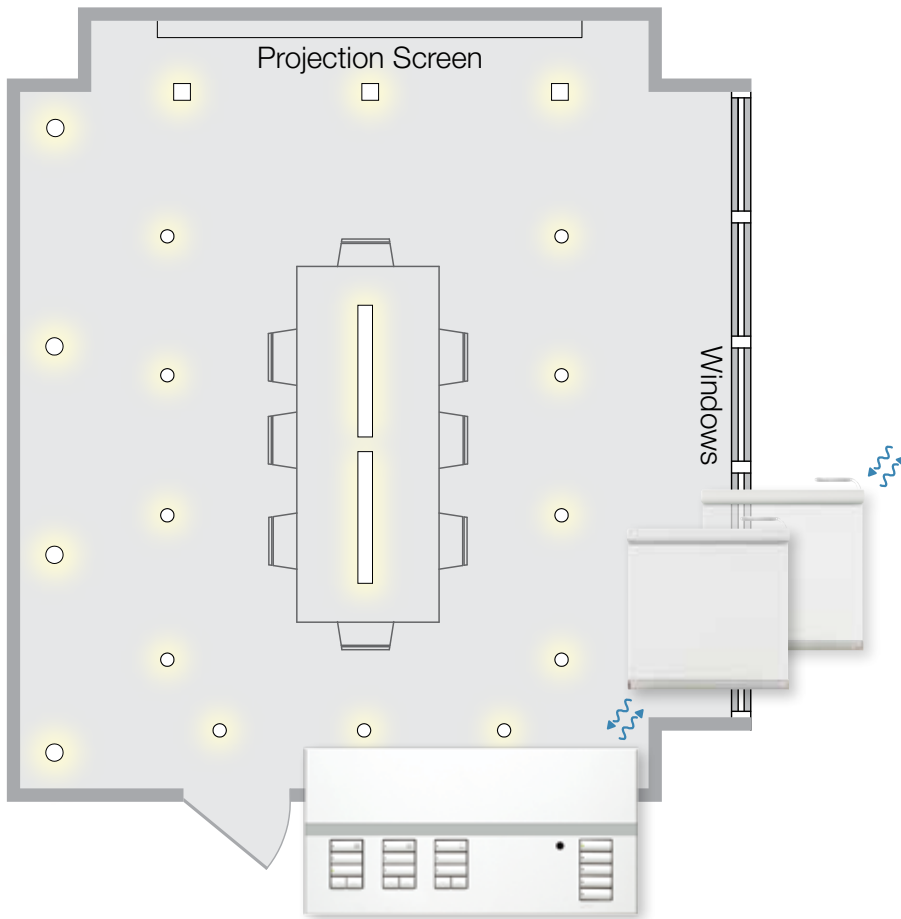

To create a complete bill of materials and obtain quotes, please refer to the shade configuration tool (SCT) or contact customer service at 1.800.446.1503 or at shadinginfo@lutron.com.

www.lutron.com/shadingsolutions



Steps to follow when designing your system

Step 4 selecting energy-saving devices

A. Select appropriate occupancy/vacancy sensors



NEW Radio Powr Savr™ **wireless occupancy/vacancy sensor**

- Installs in minutes—requires no wiring
- Front accessible setup buttons
- Cutting-edge, Lutron XCT™ sensing technology
- 10-year battery life

Ceiling mount

LRF2-OCRB-P-WH	Occupancy/ vacancy sensor
LRF2-VCRB-P-WH	Vacancy sensor

Wall mount

LRF2-OWLB-P-WH	Occupancy/ vacancy sensor
LRF2-VWLB-P-WH	Vacancy sensor

Corner mount

LRF2-OKLB-P-WH	Occupancy/ vacancy sensor
LRF2-VKLB-P-WH	Vacancy sensor

Hall mount

LRF2-OHLB-P-WH	Occupancy/ vacancy sensor
LRF2-VHLB-P-WH	Vacancy sensor



Wired Occupancy/vacancy sensors*

- Self-adaptive technology updates time and sensitivity settings to ensure that the sensors have the greatest accuracy

Wall mount¹

LOS-WDT-WH	Dual tech, 1600 sq. ft.
LOS-WDT-R-WH	Dual tech, 1600 sq. ft., with dry contact relay
LOS-WIR-WH	Infrared, 1600 sq. ft.

Ceiling mount¹

LOS-CDT-500-WH	Dual tech, 500 sq. ft.
LOS-CDT-500R-WH	Dual tech, 500 sq. ft. with dry contact relay
LOS-CDT-1000-WH	Dual tech, 1000 sq. ft.
LOS-CDT-1000R-WH	Dual tech, 1000 sq. ft., with dry contact relay
LOS-CDT-2000-WH	Dual tech, 2000 sq. ft.
LOS-CDT-2000R-WH	Dual tech, 2000 sq. ft., with dry contact relay
LOS-CUS-500-WH	Ultrasonic, 500 sq. ft.,
LOS-CUS-1000-WH	Ultrasonic, 1000 sq. ft.,
LOS-CUS-2000-WH	Ultrasonic, 2000 sq. ft.,
LOS-CIR-450-WH	Infrared, 450 sq. ft.,
LOS-CIR-1500-WH	Infrared, 1500 sq. ft.,

* All LOS series sensors are active high, 20-24 VDC, white. Use sensors with dry contact relay if connecting wired sensor to contact closure input on back of seeTouch® QS keypad

B. Select daylight sensors



NEW Radio Powr Savr wireless daylight sensor

- Gradually dims lights in response to the amount of available daylight
- Front accessible setup buttons
- 10-year battery life

LRF2-DCRB-WH



Wired daylight sensor (EcoSystem® models only)

- Gradually dims lights in response to the amount of available daylight
- Compatible with EcoSystem ballasts and modules. Consult EcoSystem documentation for more information
- Also compatible with phase control models via the QS Sensor Module (QSM)

C-SR-M1-WH

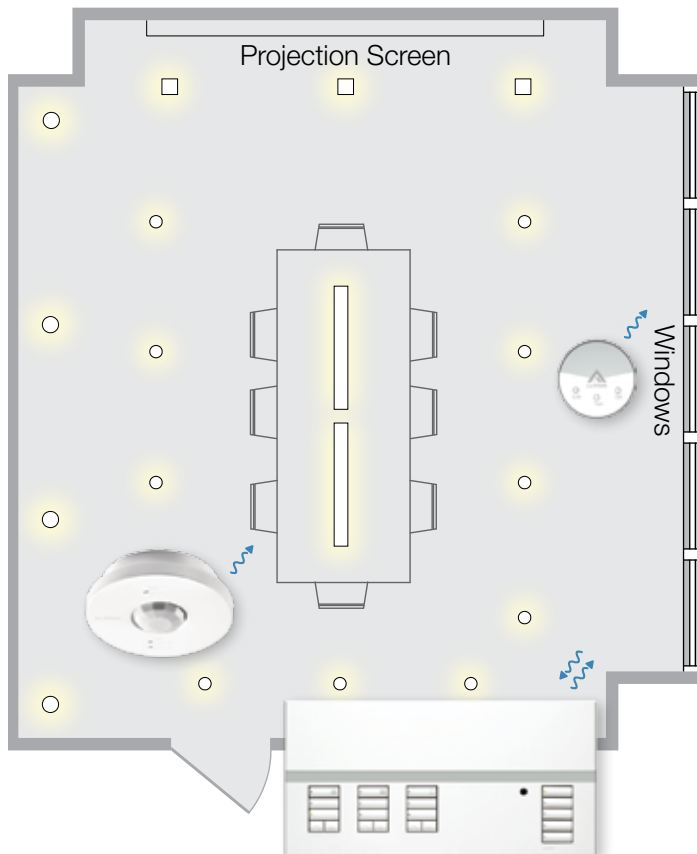

Step 5 selecting integration devices

A. Determine the type of integration needed



QS RS-232/Ethernet interface

- Provides integration with third-party touch screens, A/V equipment, HVAC, building management systems and other digital equipment
- Supports RS-232 serial communication or communications via Ethernet

QSE-CI-NWK-E



QS contact closure interface

- Provides integration with third-party equipment requiring contact closure input/output including projection screens, security systems, movable walls, time clocks and others
- Five inputs and five dry contact closure outputs

QSE-IO



QS DMX output interface

- Provides integration with third-party theatrical equipment including light machines, strobes, fog machines, animated characters, motorized fixtures and others
- Allows for control of DMX single-channel and RGB/CMY fixtures from zones on the GRAFIK Eye® QS

QSE-CI-DMX



A/V mounting rack and wall-mount

- For use with QSE-CI-NWK-E, QSE-IO, and QSE-CI-DMX

LUT-19AV-1U
LUT-5X10-ENC

A/V Mounting rack
Wall-mount enclosure



Additional components



NEW Pico® wireless controls

- No wires—control of lights and shades from anywhere
- Can function as a stylish tabletop control on a pedestal, a lightweight handheld remote, or can be mounted within a Lutron Claro® faceplate to mimic a traditional keypad
- Available in a variety of colors and button configurations



NEW Hi-lume® A-Series LED driver

- Digital addressable
- Universal voltage
- Architectural dimming to 1%
- Service-free lifetime of at least 50,000 hours
- Models available for virtually any LED fixture under 40 Watts



NEW EcoSystem® H-Series ballasts

- Digital addressable
- Universal voltage
- Dimming to 1%
- Models available for T8 32W, T5 28W and T5HO 54W
- Integrate sensors through GRAFIK Eye® QS or QS Sensor Module

EcoSystem ballasts

- Digital addressable
- Universal voltage
- Dims linear lamps to 10% and CFLs to 5%
- Models available for CFL, T8, T5, T5-HO, and T5 twin-tube lamps

For a complete listing of ballast and driver model numbers, including the Hi-lume fluorescent ballast family, please visit www.lutron.com/ballasts or reference the Fluorescent Dimming Systems Selection Guide (P/N 366-002).



QS link power supply

(powers 1 wired shade/drape)

- Provides power to QS shades, keypads, and accessories
- Plugs in to a standard receptacle

QSPS-P1-1-50



Power modules

- Three versions available:
fluorescent, switching and phase-adaptive
- Adaptive technology controls either magnetic or electronic transformers for low-voltage lighting
- **PHPM-PA-DV-WH**: 120 V phase control input, 120-277 V phase-adaptive output
- **PHPM-3F-DV-WH**: 120 V phase control input, 120-277 V 3-wire fluorescent output
- **PHPM-SW-DV-WH**: 277 V phase control input, 120-277 V switched output



Infrared partition sensors

- Allow the lighting control to automatically track how the walls of a flexible space change
- Requires a GRX-12VDC power supply and a QSE-IO, ordered separately

GRX-IRPS-WH



NEW QS sensor module

- Uses Clear Connect™ RF Technology for communication with wireless occupancy/vacancy sensors, daylight sensors, and wireless controllers
- Powered by the QS communication link—no line voltage connections are required
- Connect to and power up to 4 wired sensors and controls, QS link power supply required
- **QSM2-4W-C**: 434 MHz, North America (wired and wireless capability)
- **QSMX-4W-C**: wired-only capability
- **QSM2-XW-C**: 434 MHz North America (wireless-only capability)

Architectural load dimming connections

GRAFIK Eye® QS

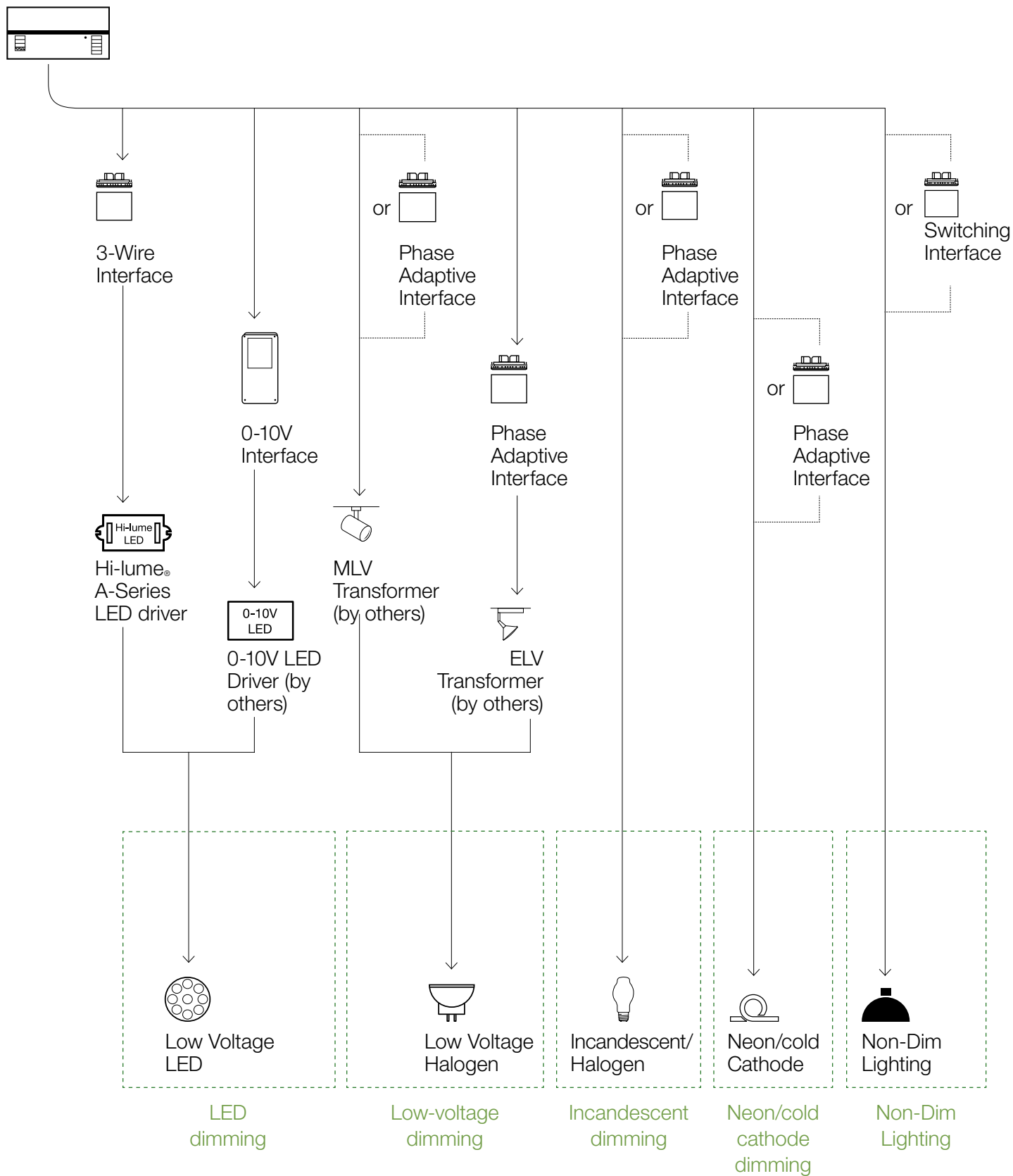

Wires and cables

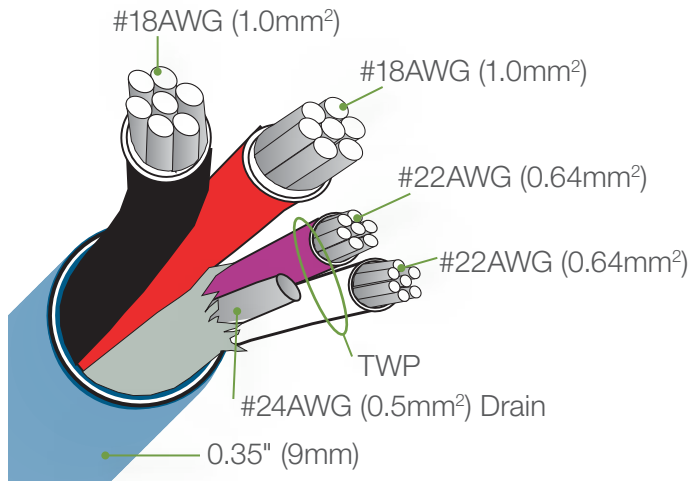

GRX-CBL-346S Cable

Description

- Non-plenum rated cable for use with GRAFIK Eye® QS Systems.

Specifications

- Listed as cable type CL3.
- Available in 500 ft. (150m) spool.
- Five conductors:
 - Common – #18AWG (1.0mm²)
 - Power – #18AWG (1.0mm²)
 - MUX Data – #22AWG (0.64mm²)
 - MUX Data – #22AWG (0.64mm²) } Twisted Wire Pair
 - Drain Wire – #24AWG (0.5mm²)
- Total Outer Jacket Diameter: 0.35" (9mm).
- 300V Rated.
- PVC Sheath, 75°C rated.
- UL/CSA Listed.
- Rated FT1.

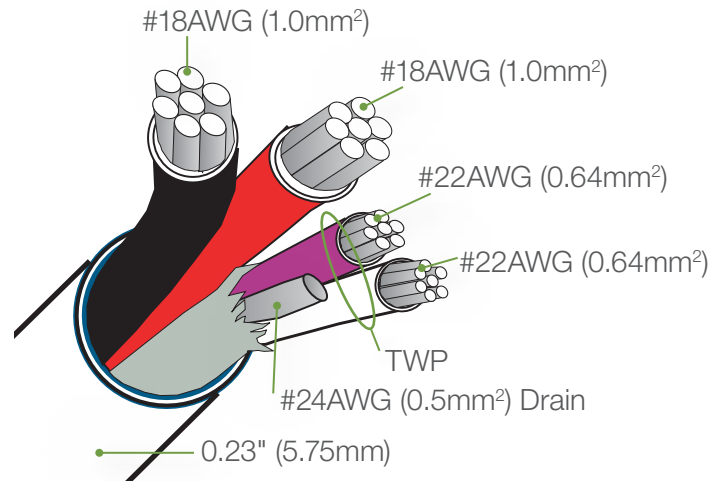

GRX-PCBL-346S Cable

Description

- For use with GRAFIK Eye QS Systems.
- Plenum rated for use in ceilings and enclosures that are also used by the building air distribution system to transport environmental air.

Specifications

- Listed as cable type CMP (Communications Plenum Cable).
- Available in 500 ft. (150m) spool.
- Five conductors:
 - Common – #18AWG (1.0mm²)
 - Power – #18AWG (1.0mm²)
 - MUX Data – #22AWG (0.64mm²)
 - MUX Data – #22AWG (0.64mm²) } Twisted Wire Pair
 - Drain Wire – #24AWG (0.5mm²)
- Total Outer Jacket Diameter: 0.23" (5.75mm).
- 300V Rated.
- Plenum sheath, 75°C rated.
- UL/CSA Listed.
- Rated FT6.

Key components system diagram

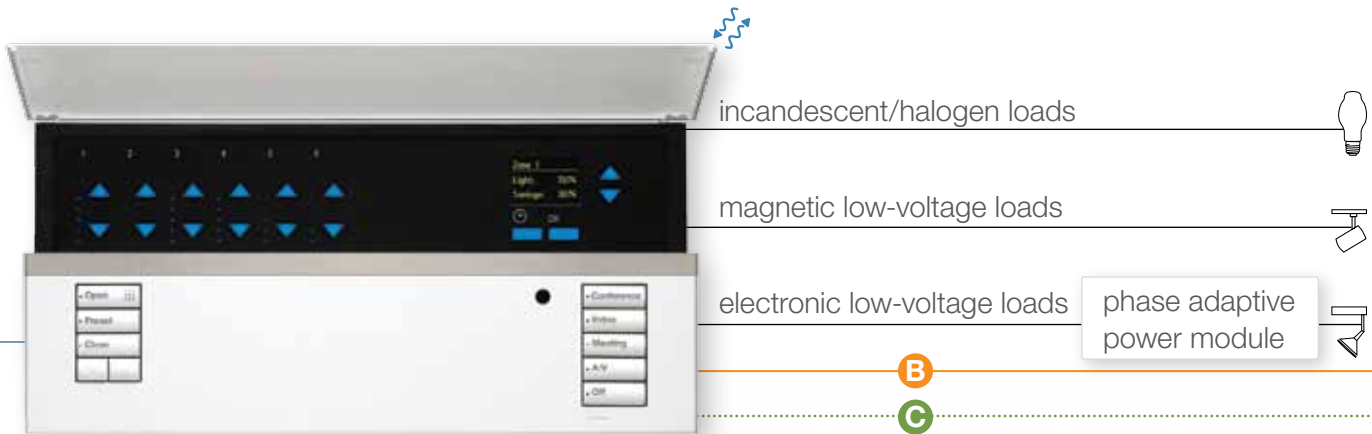

GRAFIK Eye® QS with EcoSystem® includes wired and wireless connections to control lights, shades, and energy usage automatically or with the touch of a button

- A** Low-voltage QS Link power and communications (4-conductor)
- B** Communications (2-conductor digital link)
- C** Wireless RF Communication

QS link



Quantum® provides total light management for an entire building



Sivoia® QS smart panel power supply



Sivoia QS shades reduce glare and solar heat gain for increased comfort, productivity, and energy savings, while preserving exterior views



seeTouch® QS keypads control lights and shades at the touch of a button

Additional QS devices

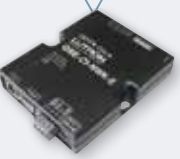

QS RS-232/Ethernet interface allows for seamless integration with A/V, HVAC, and building management systems



QS input/output device provides integration with third-party equipment requiring contact closure input/output

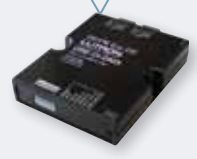

QS DMX interface provides integration with LEDs and theatrical equipment

Third-party devices

EcoSystem



Hi-lume® 3D digital addressable ballasts

provide architectural dimming to 1%



EcoSystem digital addressable ballasts

dim linear lamps to 10% and CFLs to 5%



Wired occupancy/vacancy sensor



Wired daylight sensor



EcoSystem H-Series digital addressable ballasts

provide architectural dimming to 1%



Hi-lume A-Series LED drivers

provide high-performance dimming of energy-efficient LEDs—architectural dimming to 1%

Up to 64 digital addressable ballasts or drivers

Wireless RF communication



NEW Radio Powr Savr™ wireless occupancy/vacancy sensor

automatically turns lights on/off or dims based on room occupancy/vacancy



NEW Pico® wireless control

handheld, tabletop, or wall-mount versions available to control lights and shades from anywhere in the space



NEW Radio Powr Savr wireless daylight sensor



Sivoia QS wireless panel power supply



Sivoia QS wireless shades

reduce glare and solar heat gain for increased comfort, productivity, and energy savings, while preserving exterior views

Colors and finishes

Architectural matte finishes



White
(WH) **f, s, b**



Ivory
(IV) **f, s, b**



Beige
(BE) **f, s, b**



Almond
(AL) **f, s, b**



Lt. Almond
(LA) **f, s, b**



Gray
(GR) **f, s, b**



Brown
(BR) **f, s, b**



Black
(BL) **f, s, b**

Anodized aluminium finishes



Clear
(CLA) **f, s**



Black
(BLA) **f, s**



Brass
(BRA) **f, s**

Architectural metal finishes



Bright Brass
(BB) **f, s**



Bright Chrome
(BC) **f, s**



Bright Nickel
(BN) **f, s**



Satin Brass
(SB) **f, s**



Satin Chrome
(SC) **f, s**



Satin Nickel
(SN) **f, s**



Antique Brass
(QB) **f, s**



Antique Bronze
(QZ) **f, s**

Color option guide

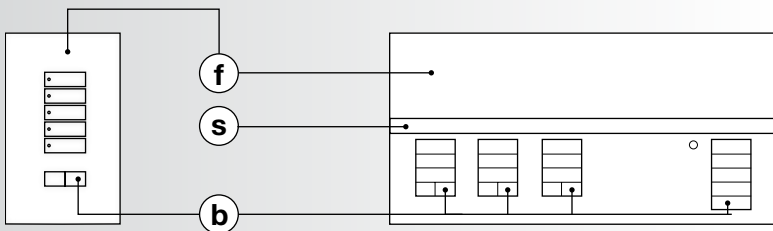

seeTouch® QS

GRAFIK Eye® QS

- f** faceplate color option
- s** stripe color option
- b** button color option

Satin Colors® matte finishes



Hot
(HT) **f, s**



Merlot
(MR) **f, s**



Plum
(PL) **f, s**



Turquoise
(TQ) **f, s**



Terracotta
(TC) **f, s**



Greenbriar
(GB) **f, s**



Bluestone
(BG) **f, s**



Mocha Stone
(MS) **f, s**



Sea Glass
(SG) **f, s**

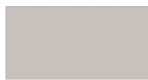

Taupe
(TP) **f, s, b**

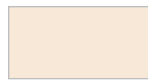

Eggshell
(ES) **f, s, b**

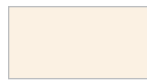

Biscuit
(BI) **f, s, b**



Goldstone
(GS) **f, s**



Desert Stone
(DS) **f, s**



Stone
(ST) **f, s**



Limestone
(LS) **f, s**

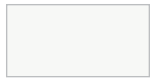

Snow
(SW) **f, s, b**



Palladium
(PD) **f, s**



Midnight
(MN) **f, s**



Sienna
(SI) **f, s**



Use the GRAFIK Eye QS Design Tool to design a system or customize a control unit. Adjust colors and engraving to visualize the control unit before purchasing.

www.lutron.com/grafikqsdesigntool

Other application: hotel ballroom

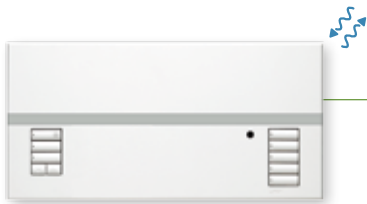

GRAFIK Eye® QS

includes wired and wireless connections to control lights, shades, and energy usage automatically or with the touch of a button



NEW Radio Powr Savr™

wireless occupancy/vacancy sensor

retrofits easily and ensures energy savings by turning on lights only when you need them



seeTouch® QS keypad

adjusts lights and shades to achieve the optimal light level for any task—all at the touch of a button



QS contact closure interface

integrates with projection screens, partition sensors, security systems, movable walls, timeclocks and other third-party equipment



Sivoia® QS drapery

quietly move precision-controlled drapery and shades at the touch of a button to reduce sun glare and solar heat gain



Infrared partition sensors

allow the lighting control to automatically track how the walls of a flexible space change

Other application: **classroom**



NEW EcoSystem® H-Series ballasts

save energy and increase productivity by managing daylight and electric light with digital addressable ballasts



NEW Radio Powr Savr™ wireless daylight sensor

adjusts electric light levels in response to the amount of available daylight

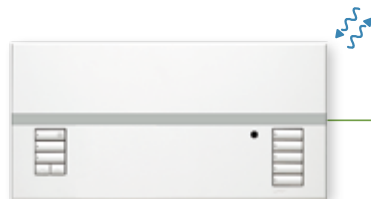

NEW GRAFIK Eye® QS with EcoSystem®

includes wired and wireless connections to control lights, shades, and energy usage automatically or with the touch of a button



NEW Radio Powr Savr wireless occupancy/vacancy sensor

retrofits easily and ensures energy savings by turning on lights only when you need them



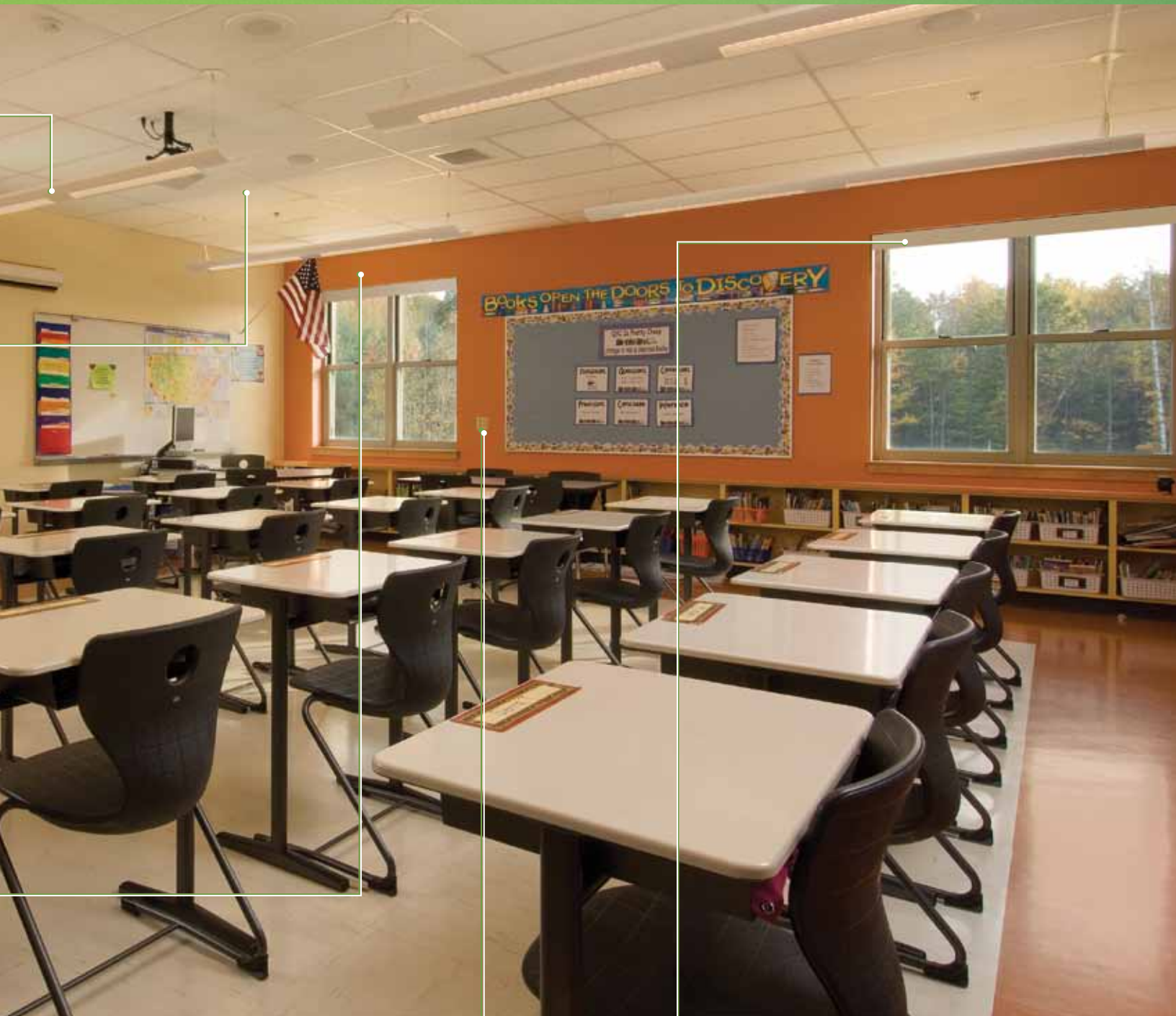

NEW Pico® wireless control

functions as a stylish tabletop control, a lightweight handheld remote, or can be wall-mounted within a Claro® faceplate to mimic a traditional keypad



Sivoia® QS shades

quietly move precision-controlled shades at the touch of a button to reduce sun glare and solar heat gain

Other application: home theater



NEW Hi-lume® A-Series LED driver
dims lights down to 1%



Sivoia® QS wireless roller shades
quietly move precision-control shades at the touch of a button to reduce sun glare and solar heat gain



seeTouch® QS keypad
adjusts lights and shades to achieve the optimal light level for any task—all at the touch of a button

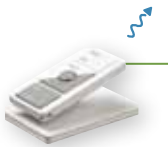

NEW Pico® wireless control
functions as a stylish tabletop control, a lightweight handheld remote, or can be wall-mounted within a Claro® faceplate to mimic a traditional keypad



QS RS-232/Ethernet interface
integrates with A/V equipment so you can easily control lights, shades, and video from one device





NEW Radio Powr Savr™
wireless occupancy/vacancy sensor
retrofits easily and ensures energy savings
by turning on lights only when you need them

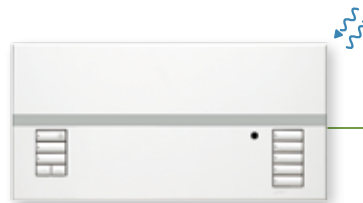

GRAFIK Eye® QS
includes wired and wireless connections
to control lights, shades, and energy usage
automatically or with the touch of a button



Aesthetics

Available in over 40 colors and finishes. The fully customizable backlit buttons make the unit easy to operate. Scene and shade buttons are large, engravable seeTouch®-style buttons.

Information screen

Displays energy savings, lighting levels, and time clock information. The intuitive display also allows for easy programming.

Astronomic time clock

Add up to 25 events per day, 7 days per week.
Add up to 25 holiday schedules. Automatically adjusts for daylight savings time. Includes after-hours capability.

Scene control

Up to 16 scenes, with direct control of scenes 1-4 and Off from the unit. 12 additional scenes are accessible via seeTouch QS keypads. Available scene fade times of 0-59 seconds or 1-60 minutes.

Zone control

Each zone has dedicated raise/lower buttons and can be programmed for high-end and low-end trim. Information screen displays standard or customized zone labels.

Zone configurations

Standard models available with 3, 4, or 6 zones.
EcoSystem® models available with 6, 8, or 16 zones.

Shade control

Direct control of up to 3 wired or wireless shade groups, cutting heating/cooling costs and reducing glare.

Personal control

Allows users in the space to select the correct light level for the desired task through infrared or radio frequency.

Digital addressable load types*

Direct control of up to 64 Hi-lume® 3D, EcoSystem, EcoSystem H-Series ballasts and Hi-lume A-Series LED drivers allowing for individual fixture control and ease of re-zoning.

Power rating**

2,000 Watt unit capacity, 800 Watt zone capacity.

QS link

The QS link is auto-addressing and supports up to 100 QS devices, 100 zones and up to 2000ft. wire length.

RF capability

Compatible with Sivoia® QS Wireless shades, Radio Powr Savr™ occupancy/vacancy and daylight sensors, Pico® wireless controls, and additional GRAFIK Eye QS units. The 434 MHz RF transceiver has a 30ft. range and connects with up to 30 Lutron wireless devices.

Contact closure input

Dry contact closure input, typically used for direct connection to occupancy/vacancy sensors, can also be utilized to trigger emergency, after-hours mode, or timeclock events.

Daylight harvesting

The Radio Powr Savr wireless daylight sensor can be used to maximize energy savings by dimming electric light in response to available daylight. EcoSystem models can also respond to wired daylight sensors, which connect directly to EcoSystem ballasts.

Occupancy/vacancy sensors

GRAFIK Eye QS provides connection to occupancy/vacancy sensors via wireless communication and/or a contact closure input. EcoSystem models respond to sensors, which connect directly to EcoSystem ballasts.

Real-Time Illumination Stability System (RTISS™)

Real-time compensation for incoming line-voltage variations to reduce or eliminate flickering.

Standards and listings

UL, CSA, CEC (Title 24), NOM, FCC, SCT, IC

Line-voltage load types**

Direct control of incandescent, halogen, magnetic low-voltage, Lutron Tu-Wire®, neon and cold cathode or non-dimmed lighting loads.

** Power modules are required for exceeding zone capacity or control of electronic low-voltage or switching non-lighting loads.

A history of sustainability, innovation, and quality



At Lutron, sustainability is not new to us. Lutron is a company built on a belief in taking care of people: customers, employees, and the community. We are a proud member of the U.S. Green Building Council. And since 1961, we have been designing industry-leading technology that saves energy and reduces green house gas emissions.

We innovate in advance of emerging market needs and continually improve our quality, our delivery, and our value.

Lutron holds over 1,700 patents and manufactures more than 15,000 products. For over 45 years, we have met and exceeded the highest standards of quality and service. Every one of our products is quality-tested before it leaves the factory.



Global service and support

You can count on a level of support unequalled anywhere in the industry and anywhere in the world. Lutron provides 24/7 technical phone support. Lutron Field Service, made up of a global network of customer-focused field service engineers, provides world-class services that begin before your building is commissioned and continue throughout the life of your building.

Resources

Access all of these resources and additional information on GRAFIK Eye QS online: www.lutron.com/GRAFIKEyeQS

GRAFIK Eye® QS design guide worksheet

Use this step-by-step worksheet to complement the Design Guide when building your GRAFIK Eye QS system. Available to download at www.lutron.com/grafikeyeqs



NEW GRAFIK Eye QS PC programming tool

Set up scenes, zones, events, and more right from your PC with this easy-to-use software. Transfer the settings to and from the unit via USB.



Use the GRAFIK Eye QS Design Tool to design a system or customize a control unit. The design tool can generate model numbers, one-line diagrams, a bill of material, load schedules and/or order forms. View it on screen or print a copy to present to your design team or client.

www.lutron.com/grafikqsdesigntool



Sources

- 1 Energy Information Administration, 2003 Commercial Buildings Energy Consumption Survey, released April 2009. (www.eia.doe.gov/emeu/cbeecs/cbeecs2003/lighting/lighting1.html)
- 2 Energy Information Administration, 2003 Commercial Buildings Energy Consumption Survey, released September 2008.
- 3 California energy study. <http://www.energy.ca.gov/efficiency/lighting/VOLUME01.PDF>
- 4 IESNA 2000 Proceedings, Paper #43: An analysis of the energy and cost savings potential of occupancy sensors for commercial lighting systems. "Occupancy sensor savings range from 17% to 60% depending upon space type and time delay settings."
- 5 US Department of Energy. How to Select Lighting Controls for Offices and Public Buildings. Claim: 27% potential savings using daylight harvesting.
- 6 IESNA 2000 Proceedings, Paper #34: Occupant Use of Manual Lighting Controls in Private Offices. "Giving the occupant manual switching and dimming provided a total of 15% added savings above the 43% achieved by motion sensors."
- 7 Lutron commissioned simulation by T.C. Chan Center for Building Simulation and Energy Studies, University of Pennsylvania, September 2008.
- 8 *Determinants of Lighting Quality II* by Newsham, G. and Veitch, J., 1996.

www.lutron.com/grafikeyeqs

World Headquarters 1.610.282.3800

Technical Support Center 1.800.523.9466 (Available 24/7)

Customer Service/Quotes 1.888.LUTRON1 (1.888.588.7661)

© 03/2011 Lutron Electronics Co., Inc. | P/N 367-1338 REV C

