

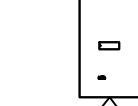













HQWA-W1BN **HQWA-W2BSN** **HQWA-W3BSN** **HQWA-W3BSRLN** **HQWA-W4BSN** **HQWA-W4SN** **HQWA-W5BN** **HQWA-W5BRLN** **HQWA-W5BIRN** **HQWA-W6BN** **HQWA-W6BRLN**

 <p>HQWA-W1BN-WH 1-Button Non-Insert Style Architectural Keypad (1 Gang US Backbox by Others) Address: X Location TBD</p>	 <p>HQWA-W2BSN-WH 2-Button Non-Insert Style Architectural Keypad (1 Gang US Backbox by Others) Address: X Location TBD</p>	 <p>HQWA-W3BSN-WH 3-Button Non-Insert Style Architectural Keypad (1 Gang US Backbox by Others) Address: X Location TBD</p>	 <p>HQWA-W3BSRLN-WH 3-Button with Raise/Lower Non-Insert Style Architectural Keypad (1 Gang US Backbox by Others) Address: X Location TBD</p>	 <p>HQWA-W4BSN-WH 4-Button Non-Insert Style Architectural Keypad (1 Gang US Backbox by Others) Address: X Location TBD</p>	 <p>HQWA-W4SN 4-Scene with Raise/Lower Non-Insert Style Architectural Keypad (1 Gang US Backbox by Others) Address: X Location TBD</p>	 <p>HQWA-W5BN-WH 5-Button Non-Insert Style Architectural Keypad (1 Gang US Backbox by Others) Address: X Location TBD</p>	 <p>HQWA-W5BRLN-WH 5-Button with Raise/Lower Non-Insert Style Architectural Keypad (1 Gang US Backbox by Others) Address: X Location TBD</p>	 <p>HQWA-W5BIRN-WH 5-Button with IR & Raise/Lower Non-Insert Style Architectural Keypad (1 Gang US Backbox by Others) Address: X Location TBD</p>	 <p>HQWA-W6BN-WH 6-Button Non-Insert Style Architectural Keypad (1 Gang US Backbox by Others) Address: X Location TBD</p>	 <p>HQWA-W6BRLN-WH 6-Button with Raise/Lower Non-Insert Style Architectural Keypad (1 Gang US Backbox by Others) Address: X Location TBD</p>
---	--	--	---	--	--	---	--	---	---	--

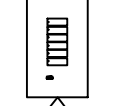
HQWA-W7BN **HQWA-W1RLDN** **HQWA-W2RLDN** **HQWA-W3BDN**

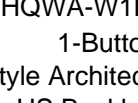
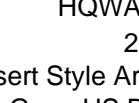
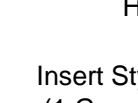
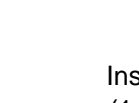
 <p>HQWA-W7BN-WH 7-Button Non-Insert Style Architectural Keypad (1 Gang US Backbox by Others) Address: X Location TBD</p>	 <p>HQWA-W1RLDN-WH Dual Group with Raise/Lower Non-Insert Style Architectural Keypad (1 Gang US Backbox by Others) Address: X Location TBD</p>	 <p>HQWA-W2RLDN-WH Dual Group with Dual Raise/Lower Non-Insert Style Architectural Keypad (1 Gang US Backbox by Others) Address: X Location TBD</p>	 <p>HQWA-W3BDN-WH Dual Group Non-Insert Style Architectural Keypad (1 Gang US Backbox by Others) Address: X Location TBD</p>
---	--	---	--



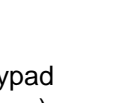
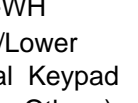
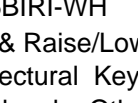
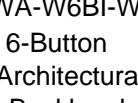

HQWA-W1BI **HQWA-W2BSI** **HQWA-W3BSI** **HQWA-W3BSRLI** **HQWA-W4BSI** **HQWA-W4SI** **HQWA-W5BI** **HQWA-W5BRLI** **HQWA-W5BIRI** **HQWA-W6BI** **HQWA-W6BRLI**

 <p>HQWA-W1BI-WH 1-Button Insert Style Architectural Keypad (1 Gang US Backbox by Others) Address: X Location TBD</p>	 <p>HQWA-W2BSI-WH 2-Button Insert Style Architectural Keypad (1 Gang US Backbox by Others) Address: X Location TBD</p>	 <p>HQWA-W3BSI-WH 3-Button Insert Style Architectural Keypad (1 Gang US Backbox by Others) Address: X Location TBD</p>	 <p>HQWA-W3BSRLI-WH 3-Button with Raise/Lower Insert Style Architectural Keypad (1 Gang US Backbox by Others) Address: X Location TBD</p>	 <p>HQWA-W4BSI-WH 4-Button Insert Style Architectural Keypad (1 Gang US Backbox by Others) Address: X Location TBD</p>	 <p>HQWA-W4SI 4-Scene with Raise/Lower Insert Style Architectural Keypad (1 Gang US Backbox by Others) Address: X Location TBD</p>	 <p>HQWA-W5BI-WH 5-Button Insert Style Architectural Keypad (1 Gang US Backbox by Others) Address: X Location TBD</p>	 <p>HQWA-W5BRLI-WH 5-Button with Raise/Lower Insert Style Architectural Keypad (1 Gang US Backbox by Others) Address: X Location TBD</p>	 <p>HQWA-W5BIRI-WH 5-Button with IR & Raise/Lower Insert Style Architectural Keypad (1 Gang US Backbox by Others) Address: X Location TBD</p>	 <p>HQWA-W6BI-WH 6-Button Insert Style Architectural Keypad (1 Gang US Backbox by Others) Address: X Location TBD</p>	 <p>HQWA-W6BRLI-WH 6-Button with Raise/Lower Insert Style Architectural Keypad (1 Gang US Backbox by Others) Address: X Location TBD</p>
---	--	--	---	--	--	---	--	---	---	--

HQWA-W7BI **HQWA-W1RLDI** **HQWA-W2RLDI** **HQWA-W3BDI**

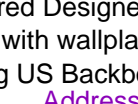
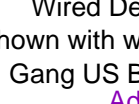
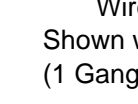
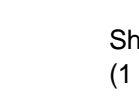
 <p>HQWA-W7BI-WH 7-Button Insert Style Architectural Keypad (1 Gang US Backbox by Others) Address: X Location TBD</p>	 <p>HQWA-W1RLDI-WH Dual Group with Raise/Lower Non-Insert Style Architectural Keypad (1 Gang US Backbox by Others) Address: X Location TBD</p>	 <p>HQWA-W2RLDI-WH Dual Group with Dual Raise/Lower Non-Insert Style Architectural Keypad (1 Gang US Backbox by Others) Address: X Location TBD</p>	 <p>HQWA-W3BDI-WH Dual Group Insert Style Architectural Keypad (1 Gang US Backbox by Others) Address: X Location TBD</p>
---	--	---	--



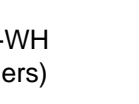
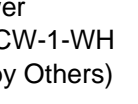
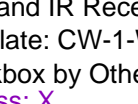
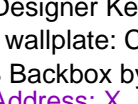



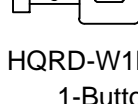
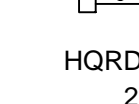

HQWD-W1B **HQWD-W2BS** **HQWD-W3BS** **HQWD-W3BSRL** **HQWD-W4BS** **HQWD-W4S** **HQWD-W5B** **HQWD-W5BRL** **HQWD-W5BIR** **HQWD-W6B** **HQWD-W6BRL**

 <p>HQWD-W1B-WH 1-Button Wired Designer Keypad Shown with wallplate: CW-1-WH (1 Gang US Backbox by Others) Address: X Location TBD</p>	 <p>HQWD-W2BS-WH 2-Button Wired Designer Keypad Shown with wallplate: CW-1-WH (1 Gang US Backbox by Others) Address: X Location TBD</p>	 <p>HQWD-W3BS-WH 3-Button Wired Designer Keypad Shown with wallplate: CW-1-WH (1 Gang US Backbox by Others) Address: X Location TBD</p>	 <p>HQWD-W3BSRL-WH 3-Button with Raise/Lower Wired Designer Keypad Shown with wallplate: CW-1-WH (1 Gang US Backbox by Others) Address: X Location TBD</p>	 <p>HQWD-W4BS-WH 4-Button Wired Designer Keypad Shown with wallplate: CW-1-WH (1 Gang US Backbox by Others) Address: X Location TBD</p>	 <p>HQWD-W4S 4-Scene Wired Designer Keypad with Raise/Lower Shown with wallplate: CW-1-WH (1 Gang US Backbox by Others) Address: X Location TBD</p>	 <p>HQWD-W5B-WH 5-Button Wired Designer Keypad Shown with wallplate: CW-1-WH (1 Gang US Backbox by Others) Address: X Location TBD</p>	 <p>HQWD-W5BRL-WH 5-Button Wired Designer Keypad with Raise/Lower Shown with wallplate: CW-1-WH (1 Gang US Backbox by Others) Address: X Location TBD</p>	 <p>HQWD-W5BIR-WH 5-Button Wired Designer Keypad with Raise/Lower and IR Receiver Shown with wallplate: CW-1-WH (1 Gang US Backbox by Others) Address: X Location TBD</p>	 <p>HQWD-W6B-WH 6-Button Wired Designer Keypad Shown with wallplate: CW-1-WH (1 Gang US Backbox by Others) Address: X Location TBD</p>	 <p>HQWD-W6BRL-WH 6-Button Wired Designer Keypad with Raise/Lower Shown with wallplate: CW-1-WH (1 Gang US Backbox by Others) Address: X Location TBD</p>
--	---	---	--	---	---	--	---	---	--	---

HQWD-W7B **HQWD-W1RLD** **HQWD-W2RLD** **HQWD-W3BD**

 <p>HQWD-W7B-WH 7-Button Wired Designer Keypad Shown with wallplate: CW-1-WH (1 Gang US Backbox by Others) Address: X Location TBD</p>	 <p>HQWD-W1RLD-WH Dual Group with Raise/Lower Wired Designer Keypad Shown with wallplate: CW-1-WH (1 Gang US Backbox by Others) Address: X Location TBD</p>	 <p>HQWD-W2RLD-WH Dual Group with Dual Raise/Lower Wired Designer Keypad Shown with wallplate: CW-1-WH (1 Gang US Backbox by Others) Address: X Location TBD</p>	 <p>HQWD-W3BD-WH Dual Group Wired Designer Keypad Shown with wallplate: CW-1-WH (1 Gang US Backbox by Others) Address: X Location TBD</p>
--	---	--	---

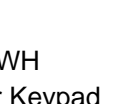



HQRD-W1B **HQRD-W2BS** **HQRD-W3BS** **HQRD-W3BSRL** **HQRD-W4BS** **HQRD-W4S** **HQRD-W5B** **HQRD-W5BRL** **HQRD-W6B** **HQRD-W6BRL**

 <p>HQRD-W1B-WH 1-Button RF Designer Keypad Shown with wallplate: CW-1-WH (1 Gang US Backbox by Others) Address: X Location TBD</p>	 <p>HQRD-W2BS-WH 2-Button RF Designer Keypad Shown with wallplate: CW-1-WH (1 Gang US Backbox by Others) Address: X Location TBD</p>	 <p>HQRD-W3BS-WH 3-Button RF Designer Keypad Shown with wallplate: CW-1-WH (1 Gang US Backbox by Others) Address: X Location TBD</p>	 <p>HQRD-W3BSRL-WH 3-Button with Raise/Lower RF Designer Keypad Shown with wallplate: CW-1-WH (1 Gang US Backbox by Others) Address: X Location TBD</p>	 <p>HQRD-W4BS-WH 4-Button RF Designer Keypad Shown with wallplate: CW-1-WH (1 Gang US Backbox by Others) Address: X Location TBD</p>	 <p>HQRD-W4S 4-Scene RF Designer Keypad with Raise/Lower Shown with wallplate: CW-1-WH (1 Gang US Backbox by Others) Address: X Location TBD</p>	 <p>HQRD-W5B-WH 5-Button RF Designer Keypad Shown with wallplate: CW-1-WH (1 Gang US Backbox by Others) Address: X Location TBD</p>	 <p>HQRD-W5BRL-WH 5-Button RF Designer Keypad with Raise/Lower Shown with wallplate: CW-1-WH (1 Gang US Backbox by Others) Address: X Location TBD</p>	 <p>HQRD-W6B-WH 6-Button RF Designer Keypad Shown with wallplate: CW-1-WH (1 Gang US Backbox by Others) Address: X Location TBD</p>	 <p>HQRD-W6BRL-WH 6-Button RF Designer Keypad with Raise/Lower Shown with wallplate: CW-1-WH (1 Gang US Backbox by Others) Address: X Location TBD</p>
---	--	--	---	--	--	---	--	---	--



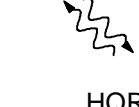



HQRD-W7B **HQRD-W1RLD** **HQRD-W2RLD** **HQRD-W3BD**

 <p>HQRD-W7B-WH 7-Button RF Designer Keypad Shown with wallplate: CW-1-WH (1 Gang US Backbox by Others) Address: X Location TBD</p>	 <p>HQRD-W1RLD-WH Dual Group with Raise/Lower RF Designer Keypad Shown with wallplate: CW-1-WH (1 Gang US Backbox by Others) Address: X Location TBD</p>	 <p>HQRD-W2RLD-WH Dual Group with Dual Raise/Lower RF Designer Keypad Shown with wallplate: CW-1-WH (1 Gang US Backbox by Others) Address: X Location TBD</p>	 <p>HQRD-W3BD-WH Dual Group RF Designer Keypad Shown with wallplate: CW-1-WH (1 Gang US Backbox by Others) Address: X Location TBD</p>
---	--	---	--

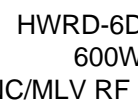
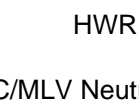
HQR-T5RL **HQR-T5CRL** **HQR-T10RL** **HQR-T10CRL** **HQR-T15RL** **HQR-T15CRL**

 <p>HQR-T5RL-SW 5-Button Table Top Master Control with Raise/Lower & All On/All Off Dimensions: 3.25"(H) x 3.56"(W) x 1"(D) Address: X Location TBD</p>	 <p>HQR-T5CRL-SW 5-Button Table Top Master Control with Column Raise/Lower Dimensions: 3.25"(H) x 3.56"(W) x 1"(D) Address: X Location TBD</p>	 <p>HQR-T10RL-SW 10-Button Table Top Master Control with Raise/Lower & All On/All Off Dimensions: 3.25"(H) x 3.56"(W) x 1"(D) Address: X Location TBD</p>	 <p>HQR-T10CRL-SW 10-Button Table Top Master Control with Column Raise/Lower Dimensions: 3.25"(H) x 3.56"(W) x 1"(D) Address: X Location TBD</p>	 <p>HQR-T15RL-SW 15-Button Table Top Master Control with Raise/Lower & All On/All Off Dimensions: 3.25"(H) x 3.56"(W) x 1"(D) Address: X Location TBD</p>	 <p>HQR-T15CRL-SW 15-Button Table Top Master Control with Column Raise/Lower Dimensions: 3.25"(H) x 3.56"(W) x 1"(D) Address: X Location TBD</p>
---	--	---	--	---	--



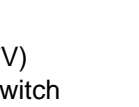
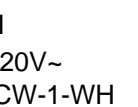
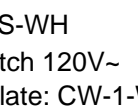
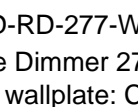



HQRD-6D **HQRD-6ND** **HQRD-6NA** **HQRD-6NE** **HQRD-F6AN-DV** **HQRD-8ANS** **HQRD-8S-DV** **HQRD-RD** **HQRD-RS** **HQRD-RD-277** **HQRD-RS-277**

 <p>HQRD-6D-WH 600W INC/MLV RF Dimmer Shown with wallplate: CW-1-WH (1 Gang US Backbox by Others) Address: X Location TBD</p>	 <p>HQRD-6ND-WH 600W INC/MLV Neutral Wire RF Dimmer Shown with wallplate: CW-1-WH (1 Gang US Backbox by Others) Address: X Location TBD</p>	 <p>HQRD-6NA-WH 600W Adaptive Neutral Wire RF Dimmer Shown with wallplate: CW-1-WH (1 Gang US Backbox by Others) Address: X Location TBD</p>	 <p>HQRD-6NE-WH 600W/VA ELV (120V-) Neutral Wire RF Dimmer Shown with wallplate: CW-1-WH (1 Gang US Backbox by Others) Address: X Location TBD</p>	 <p>HQRD-F6AN-DV-WH 6A Fluorescent Dimmer 3-Wire Dimmer Shown with wallplate: CW-1-WH (1 Gang US Backbox by Others) Address: X Location TBD</p>	 <p>HQRD-8ANS-WH 8A Neutral Wire RF Electronic Switch Shown with wallplate: CW-1-WH (1 Gang US Backbox by Others) Address: X Location TBD</p>	 <p>HQRD-8S-DV-WH 8A Non-Neutral (120V/277V) Dual-Voltage RF Electronic Switch Shown with wallplate: CW-1-WH (1 Gang US Backbox by Others) Address: X Location TBD</p>	 <p>HQRD-RD-WH Remote Dimmer 120V- Shown with wallplate: CW-1-WH (1 Gang US Backbox by Others) Address: X Location TBD</p>	 <p>HQRD-RS-WH Remote Switch 120V- Shown with wallplate: CW-1-WH (1 Gang US Backbox by Others) Address: X Location TBD</p>	 <p>HQRD-RD-277-WH Remote Dimmer 277V- Shown with wallplate: CW-1-WH (1 Gang US Backbox by Others) Address: X Location TBD</p>	 <p>HQRD-RS-277-WH Remote Switch 277V- Shown with wallplate: CW-1-WH (1 Gang US Backbox by Others) Address: X Location TBD</p>
---	---	--	--	---	---	--	--	--	--	--

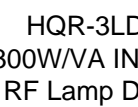
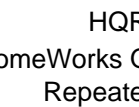
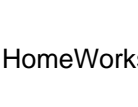

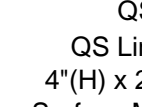
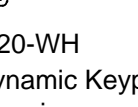

HQRD-10D **HQRD-10ND**

 <p>HQRD-10D-WH 1000W INC/MLV RF Dimmer Shown with wallplate: CW-1-WH (1 Gang US Backbox by Others) Address: X Location TBD</p>	 <p>HQRD-10ND-WH 1000W INC/MLV Neutral Wire RF Dimmer Shown with wallplate: CW-1-WH (1 Gang US Backbox by Others) Address: X Location TBD</p>
---	---

HQR-3LD **HQR-REP-120** **HQR-VCRX-WH** **LR-3B-H-SW** **HQ-J-DK420 (wired)** **HQ-J-DK420 (RF)** **HQR-15APS-1** **HQR-3PD-1** **Typical Module** **HQRD-WPM-6D-120**

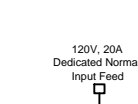
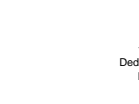
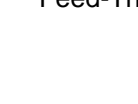
 <p>HQR-3LD-SW 300W/VA INC, MLV RF Lamp Dimmer Dimensions: 4.68"(H) x 2.94"(W) x 1"(D) Address: X Location TBD</p>	 <p>HQR-REP-120 HomeWorks QS Hybrid Repeater Dimensions: 5.25"(H) x 4.25"(W) x 1"(D) Address: X Location TBD</p>	 <p>HQR-VCRX-WH HomeWorks QS Visor Control Receiver Dimensions: 5.25"(H) x 4.25"(W) x 1"(D) Address: X Location TBD</p>	 <p>LR-3B-H-SW HomeWorks QS Visor Control Transmitter Address: X Location TBD</p>	 <p>HQ-J-DK420-WH HomeWorks QS Dynamic Keypad Control Dimensions: 5.17"(H) x 2.38"(W) x 0.5"(D) Mounting Frame Dimensions: 4.25"(H) x 1.63"(W) x 2.25"(D) Address: X Location TBD</p>	 <p>HQ-J-DK420-WH HomeWorks QS Dynamic Keypad Control Dimensions: 5.17"(H) x 2.38"(W) x 0.5"(D) Mounting Frame Dimensions: 4.25"(H) x 1.63"(W) x 2.25"(D) Address: X Location TBD</p>	 <p>HQR-15APS-1 OSPS-P1-1-50 OS Link Power Supply 4"(H) x 2.75"(W) x 1.25"(D) Surface Mount (as shown) or J-Box mount with OSPS-P1-50</p>	 <p>HQR-3PD-1 HQR-3PD-1-SW 12 1/2 HP or 15A 300W Plug-In Appliance Module Device Dimensions: 3.25"(H) x 2.25"(W) x 1.25"(D) Receptacle Cord Length: 6' Plug Cord Length: 24' Address: X Location TBD</p>	 <p>Typical Module Zone #</p>	 <p>HQRD-WPM-6D-120 6 Zone HomeWorks QS Wallbox Power Module (4 Gang US Backbox by Others) Address: X Location TBD</p>
--	--	---	---	---	---	---	--	---	--

LV21_w_1_Proc **LV21_w_2_Proc** **PNL-8_w_MI** **HWI-PNL-5** **PNL-8_w_TV** **HWBP-2S** **HW_P-8D**

 <p>HQ-LV21-120 HomeWorks QS Enclosure with (1) OSPS-DH-1-40 Power Supply and (1) HQPS-2-120 HomeWorks QS Processor Enclosure Dimensions: 21"(H) x 14.375"(W) x 3.875"(D) Address: X Location TBD</p>	 <p>HQ-LV21-120 HomeWorks QS Enclosure with (2) OSPS-DH-1-40 Power Supply and (2) HQPS-2-120 HomeWorks QS Processor Enclosure Dimensions: 21"(H) x 14.375"(W) x 4.125"(D) Address: X Location TBD</p>	 <p>HWI-PNL-8 HomeWorks QS Remote Power Feed-Thru Panel with HWI-MI-120 Module Interface and (8) 4A, (8) 4A, (8) 4R, (8) 4FSQ, (8) 4M Remote Power Modules Panel Dimensions: 32"(H) x 14.375"(W) x 4.125"(D) Address: X Location TBD</p>	 <p>HWI-PNL-8 HomeWorks QS Remote Power Feed-Thru Panel with HWI-MI-120 Module Interface, and (2) HWI-MI-120 Module Interface and (2) HWI-MI-4R Remote Power Modules Panel Dimensions: 32"(H) x 14.375"(W) x 4.125"(D) Address: X Location TBD</p>	 <p>HWBP-2S HWBP-2S-20-120L3 Remote Power Panel with (8) 20A Branch Circuit Breakers, (1) HWI-MI-120 Module Interface and (2) HWI-MI-4R Remote Power Modules Panel Dimensions: 24"(H) x 14.375"(W) x 4.125"(D) Address: X Location TBD</p>	 <p>HW_P-8D HW_P-8D-120L Remote Power Panel with (8) 20A FCI Branch Circuit Breakers, (1) HWI-MI-120 Module Interface, and (8) 4A, (8) 4A, (8) 4R, (8) 4FSQ, (8) 4M Remote Power Modules Panel Dimensions: 24"(H) x 14.375"(W) x 4.125"(D) Address: X Location TBD</p>
---	---	--	--	--	--