

APPENDIX: WIRING DIAGRAMS

Linear 1-Lamp 3-Wire Control Method

One Lamp

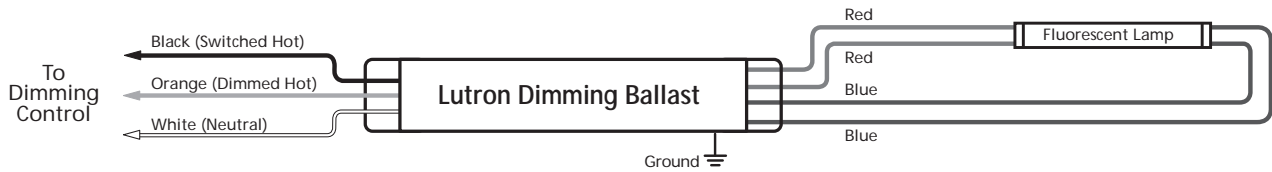

Linear 2-Lamp 3-Wire Control Method

Two Lamps

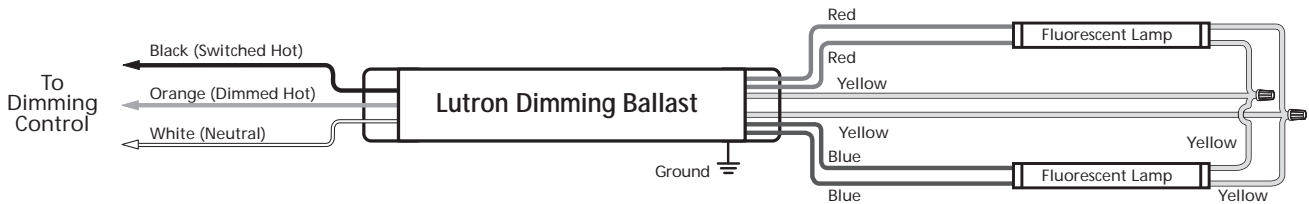

Linear 3-Lamp 3-Wire Control Method

Three Lamps

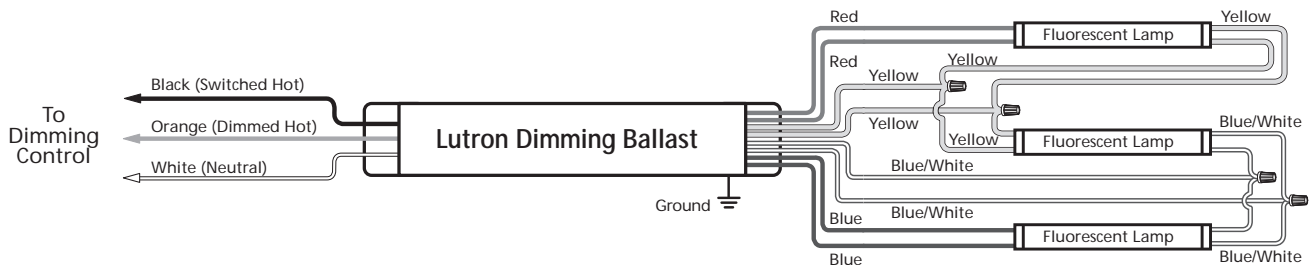

Note: Ballast-to-lamp wire lead lengths must not exceed 7.00' (2.13m) for all wiring scenarios shown above.

APPENDIX: WIRING DIAGRAMS

T5 Twin Tube 1-Lamp 3-Wire Control Method

One Lamp

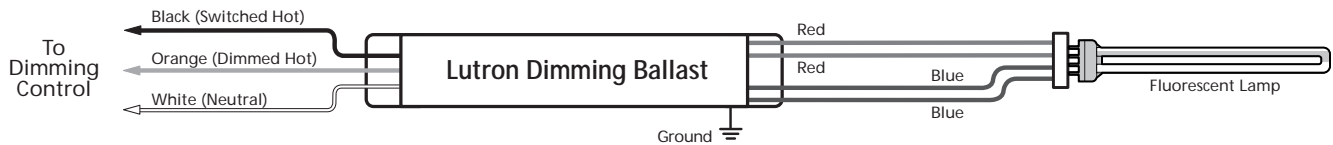

T5 Twin Tube 2-Lamp 3-Wire Control Method

Two Lamps



T5 Twin Tube 3-Lamp 3-Wire Control Method

Three Lamps

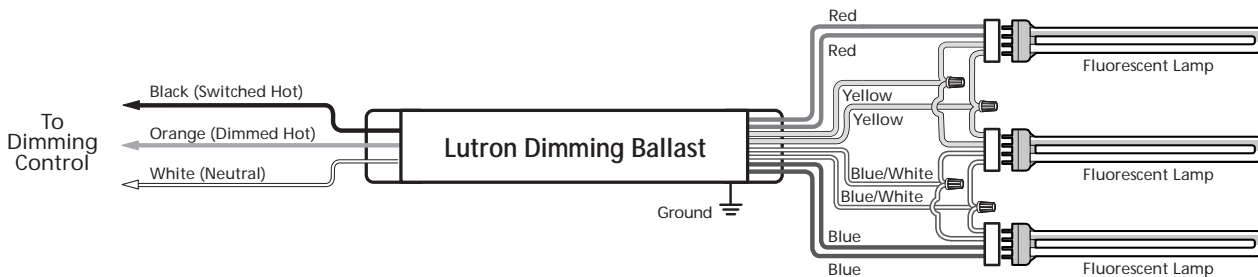

Note: Ballast-to-lamp wire lead lengths must not exceed 3.00' (0.91m) for all wiring scenarios shown above.

APPENDIX: WIRING DIAGRAMS

T4 1-Lamp 3-Wire Control Method

One Lamp

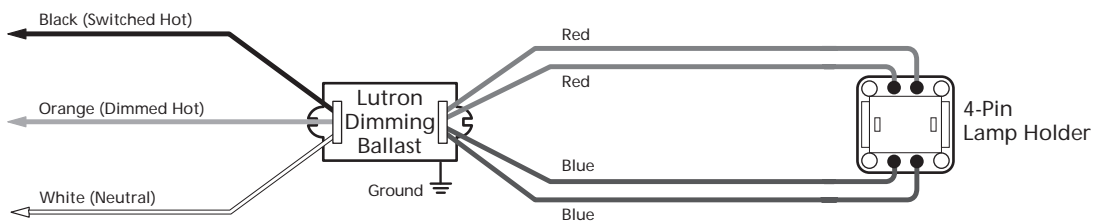

T4 2-Lamp 3-Wire Control Method

Two Lamps

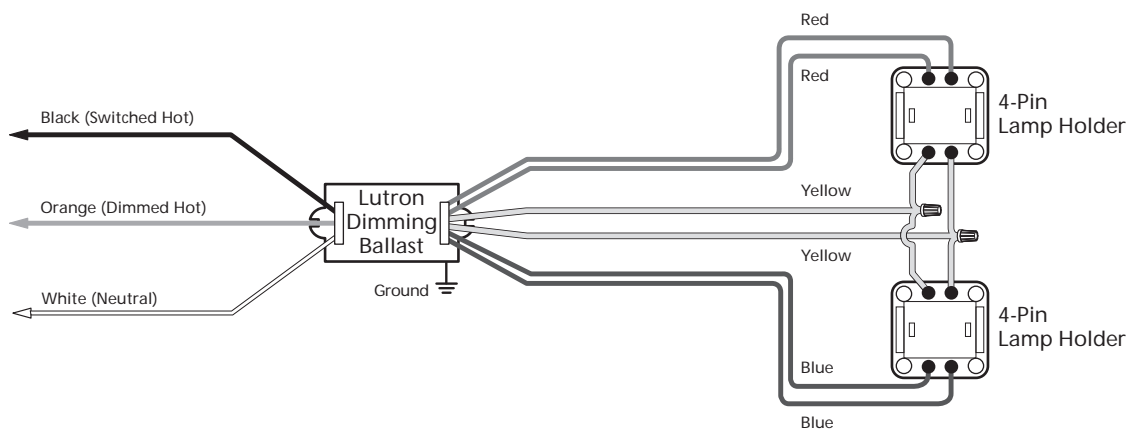

Note: Ballast-to-lamp wire lead lengths must not exceed 3.00' (0.91m) for all wiring scenarios shown above.

APPENDIX: WIRING DIAGRAMS

Linear 1-Lamp 4-Wire (0-10V) Control Method

One Lamp

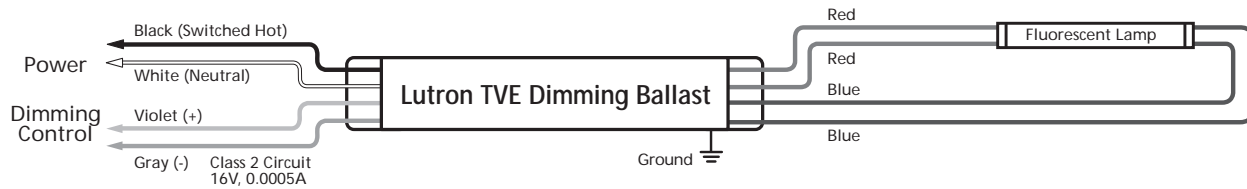

Linear 2-Lamp 4-Wire (0-10V) Control Method

Two Lamps

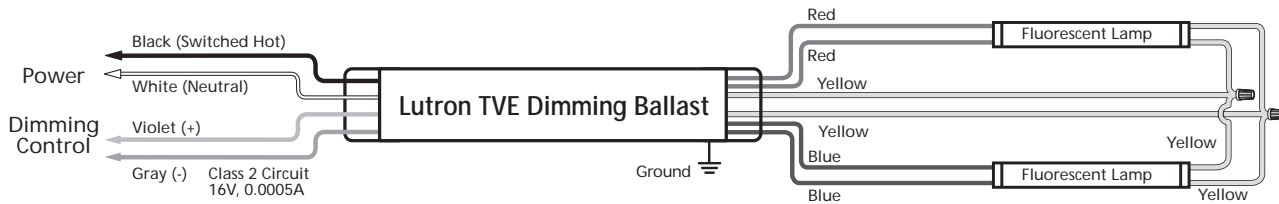

Linear 3-Lamp 4-Wire (0-10V) Control Method

Three Lamps

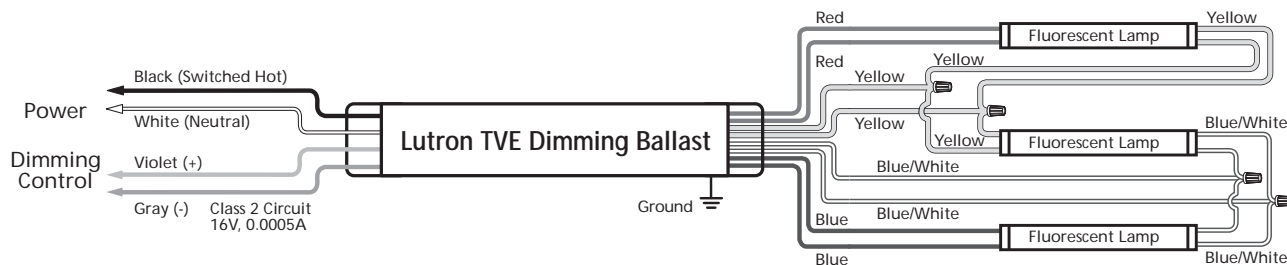

Note: Ballast-to-lamp wire lead lengths must not exceed 7.00' (2.13m) for all wiring scenarios shown above.

APPENDIX: WIRING DIAGRAMS

Linear 1-Lamp 2-Wire Control Method

One Lamp Linear Fluorescent

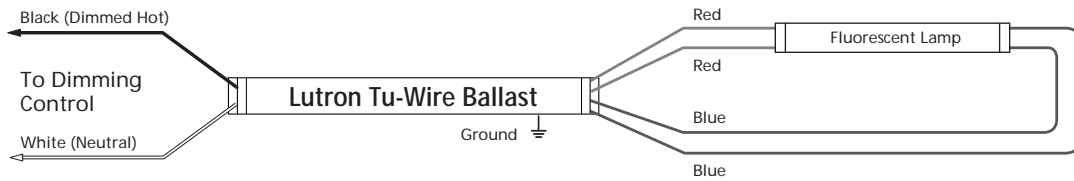

Linear 2-Lamp 2-Wire Control Method

Two Lamps Linear Fluorescent

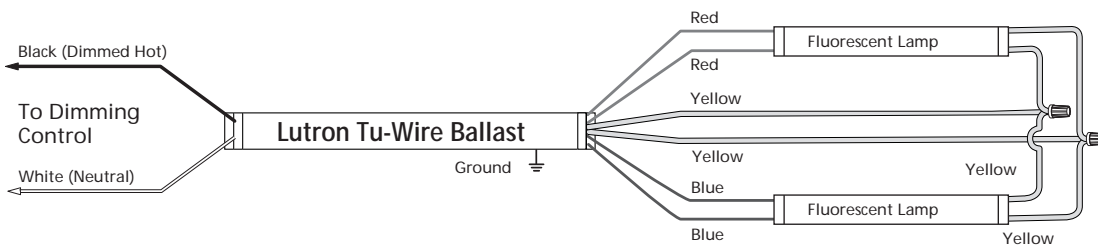

Note: Ballast-to-lamp wire lead lengths must not exceed 7.00' (2.13m) for all wiring scenarios shown above.

APPENDIX: WIRING DIAGRAMS

T4 1-Lamp 2-Wire Control Method

One Lamp Compact Fluorescent

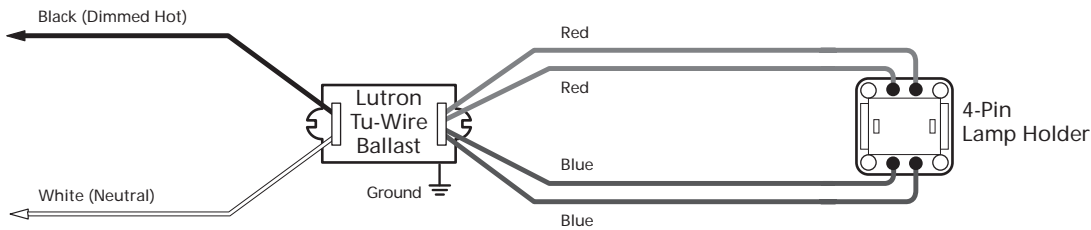

T4 2-Lamp 2-Wire Control Method

Two Lamps Compact Fluorescent

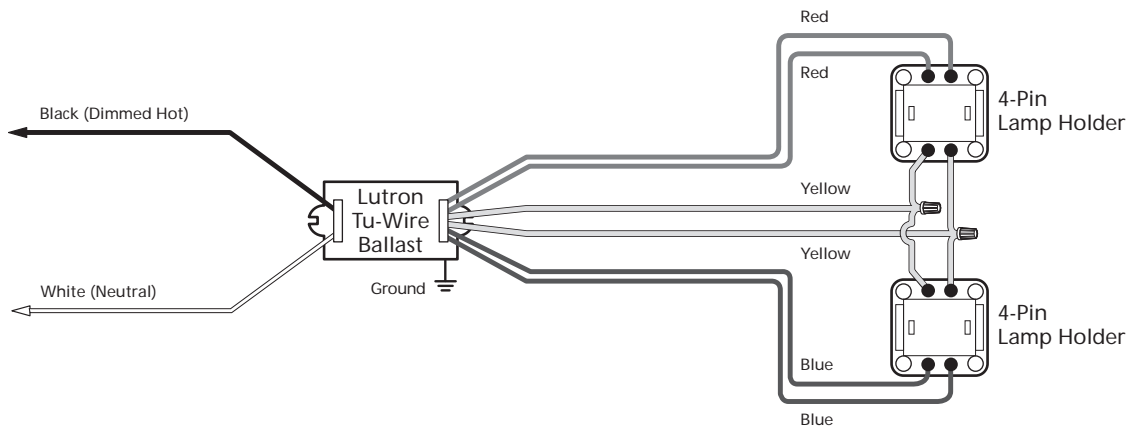

Note: Ballast-to-lamp wire lead lengths must not exceed 3.00' (0.91m) for all wiring scenarios shown above.