

Shade Equipment.slb

GRX-4M-GC

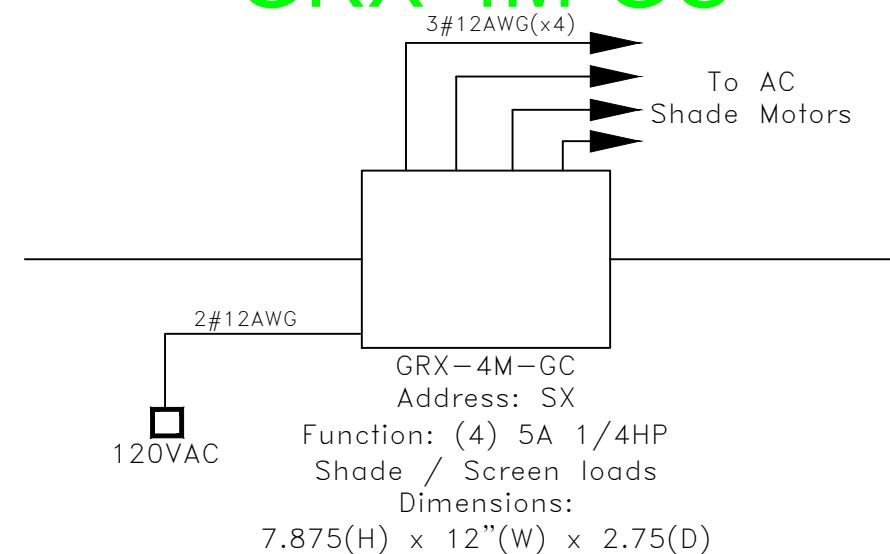

NT-SHD2

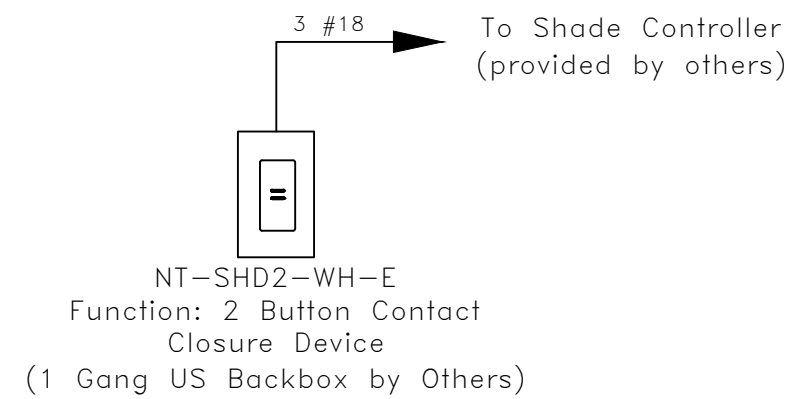

NT-SHD3

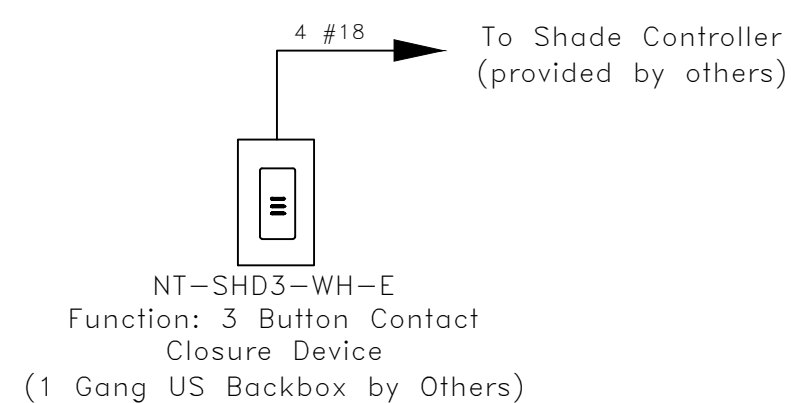

NT-SHD4

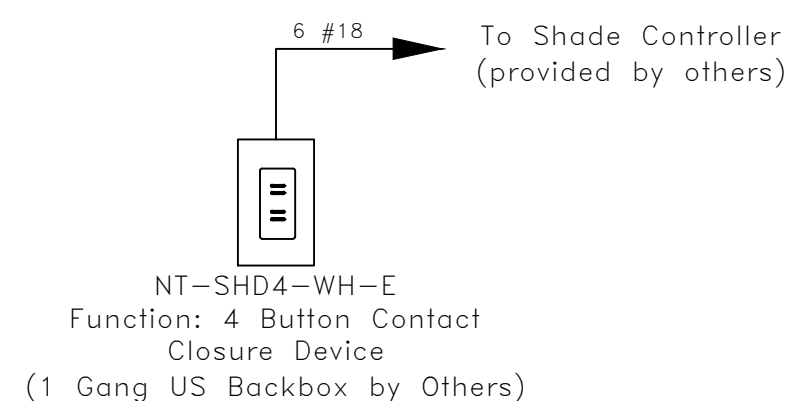

NT-SHD5

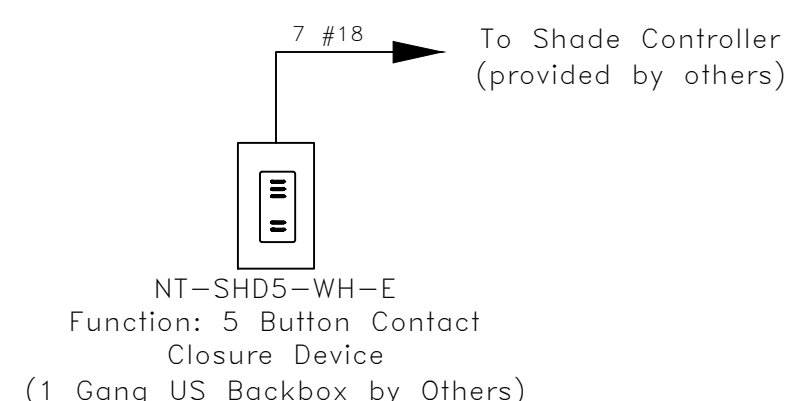

NT-SHD6

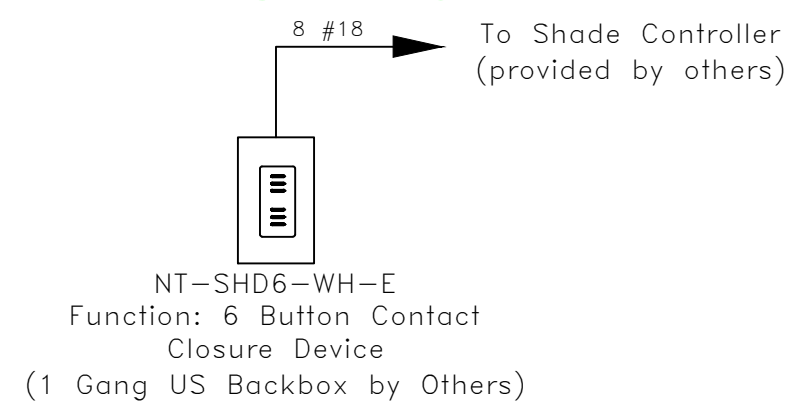

QED Drapery

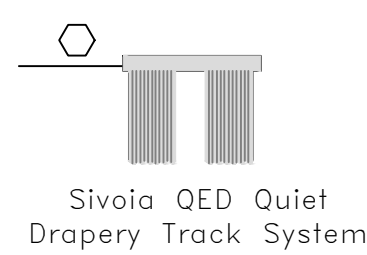

QED Roller

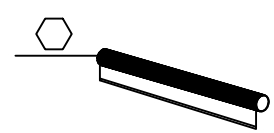

Sivoia QED Electronic Drive Unit (EDU)
(Typical of up to 10)

SA-2WDI-WH-CPN1858

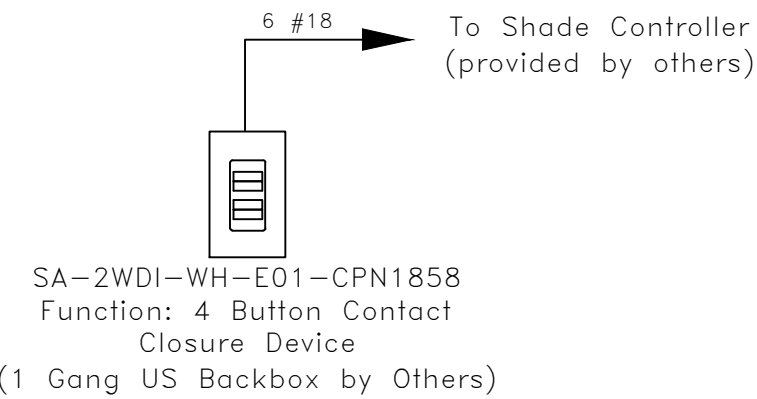

SA-2WI-WH-CPN1856

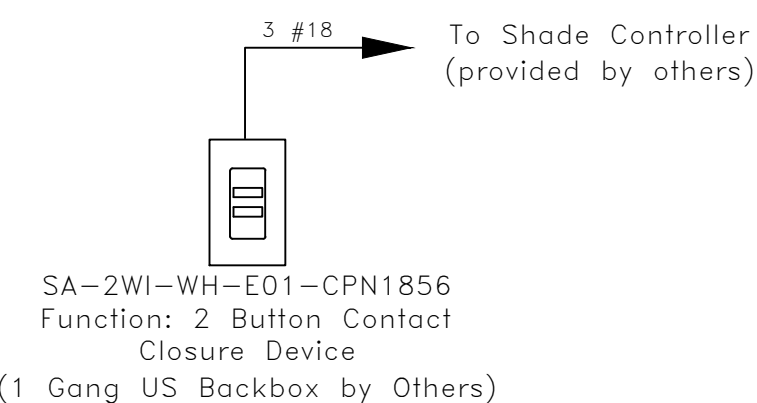

SA-3WDI-WH-CPN1860

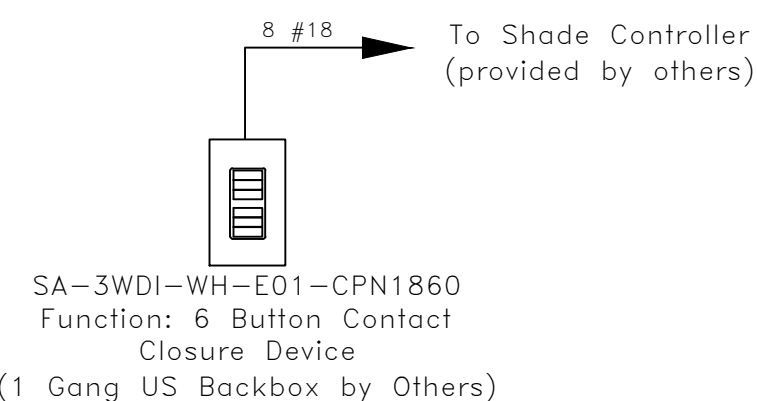

SA-3WI-WH-CPN1857

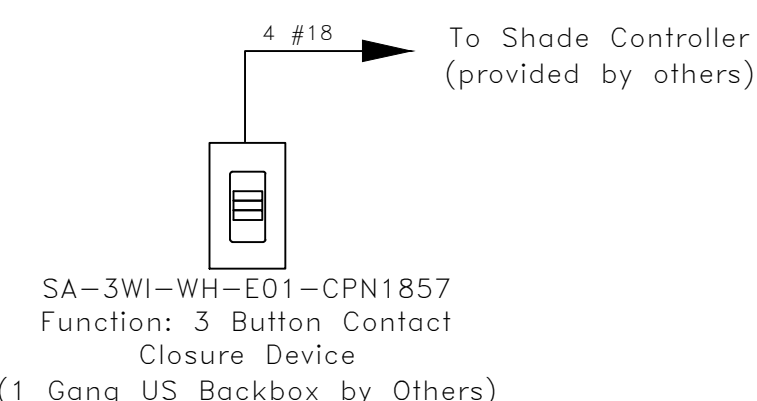

SA-5WI-WH-CPN1859

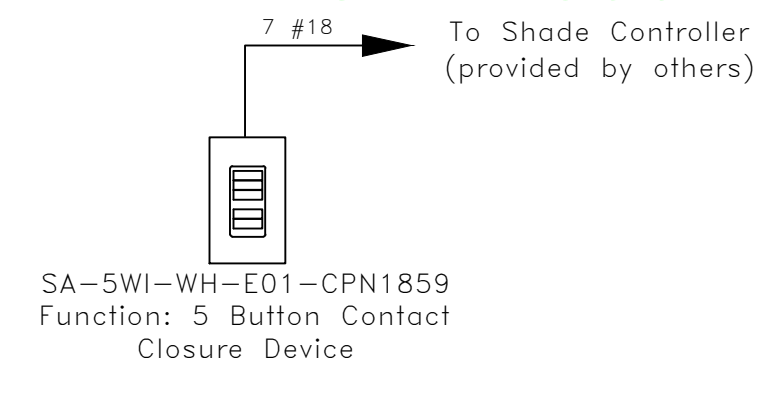

SA-7WI-WH-CPN1861

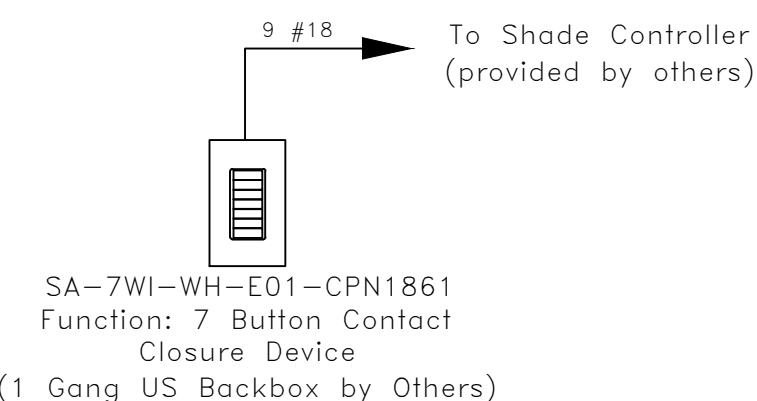

SG-2W

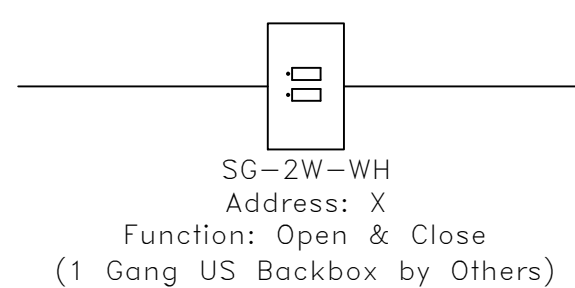

SG-3W

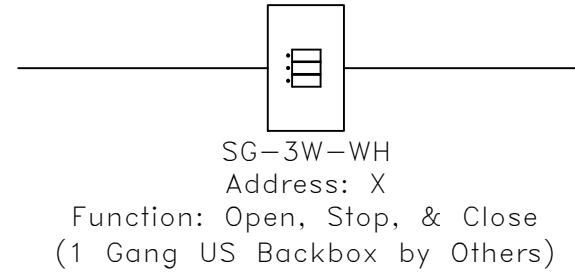

SG-3WD

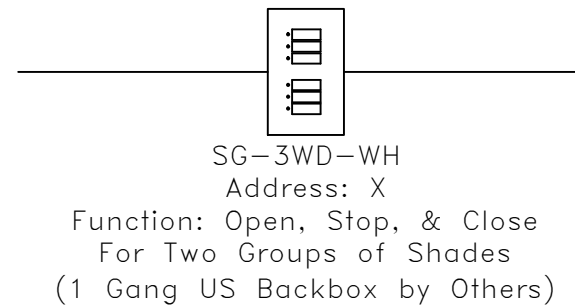

SG-3WRL

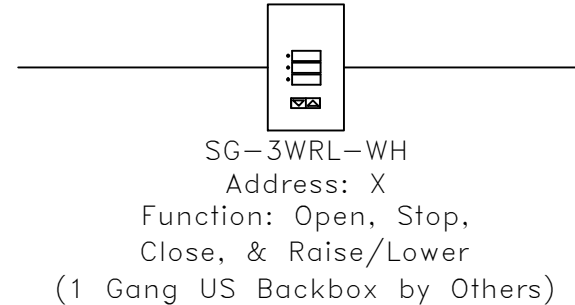

SG-5WRL

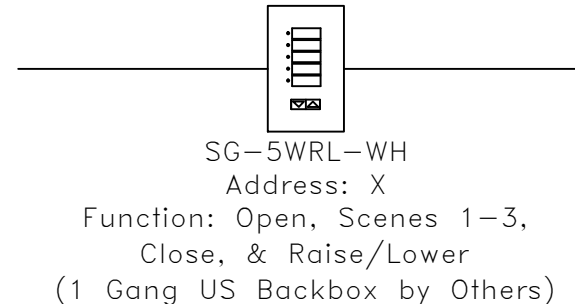

SG-SVC

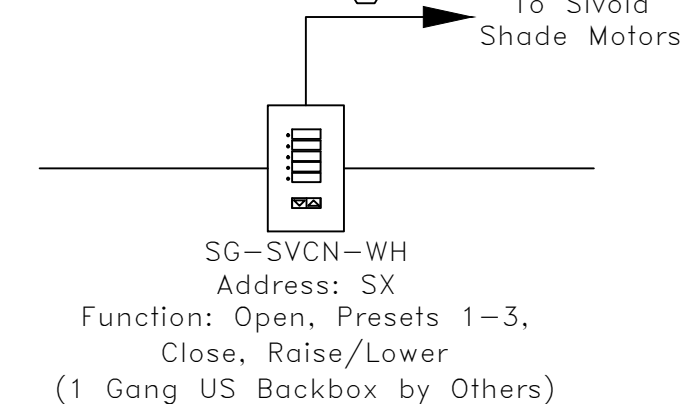

Shade Wiring Note

○ Sivoia link requires Lutron cable SVQ-CBL-250 or 2 #16(Power), 1 #18 (Gnd) plus 4 #18 Twisted and Shielded.

SO-2W

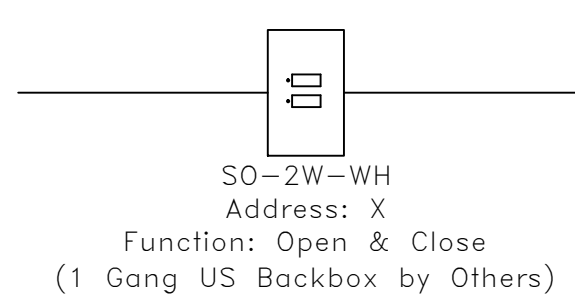

SO-3W

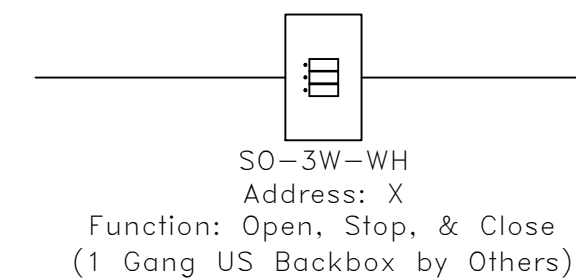

SO-3WD

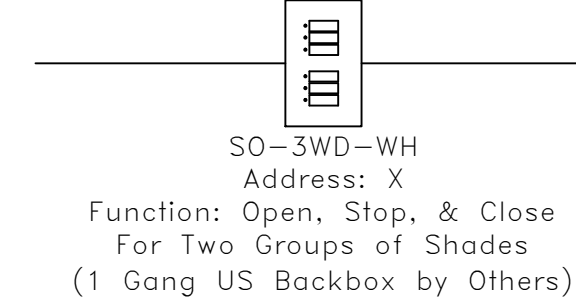

SO-3WRL

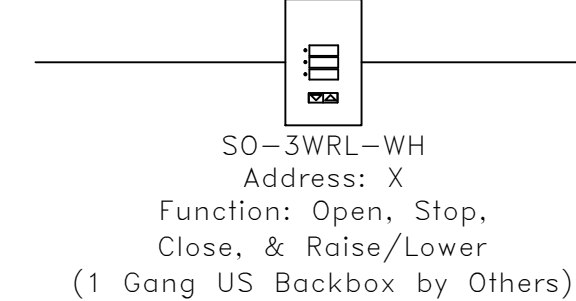

SO-5WRL

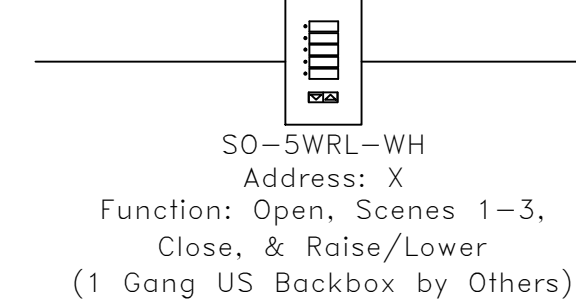

SO-SVC

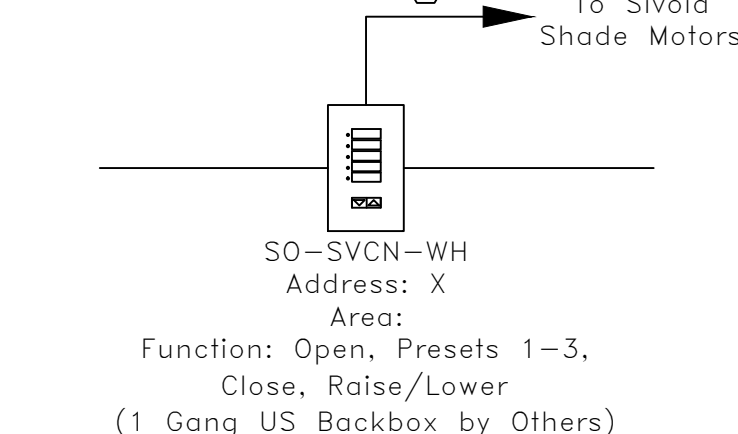

SVQ-10-PNL (Detail)

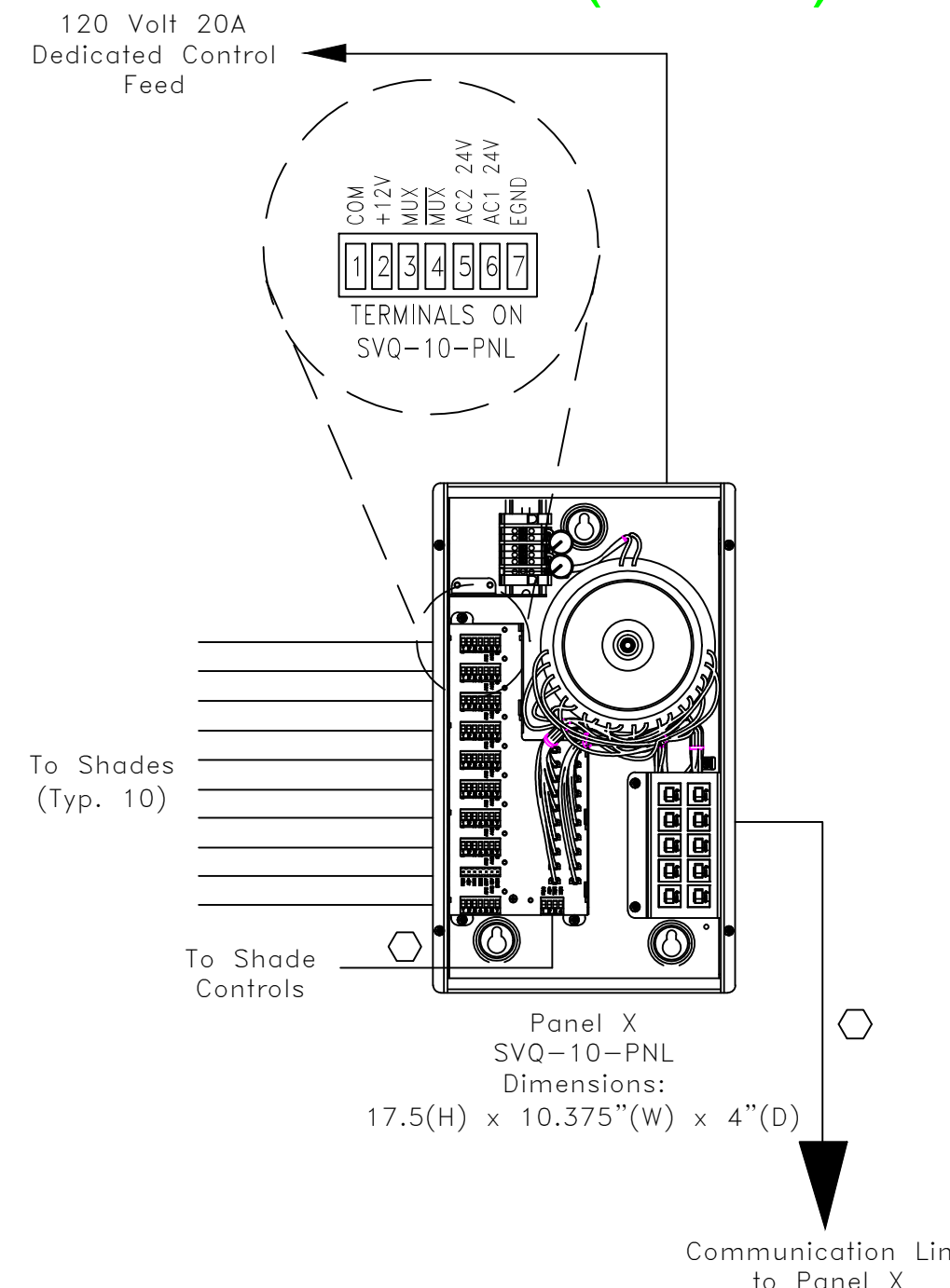

SVQ-10-PNL (Icon)

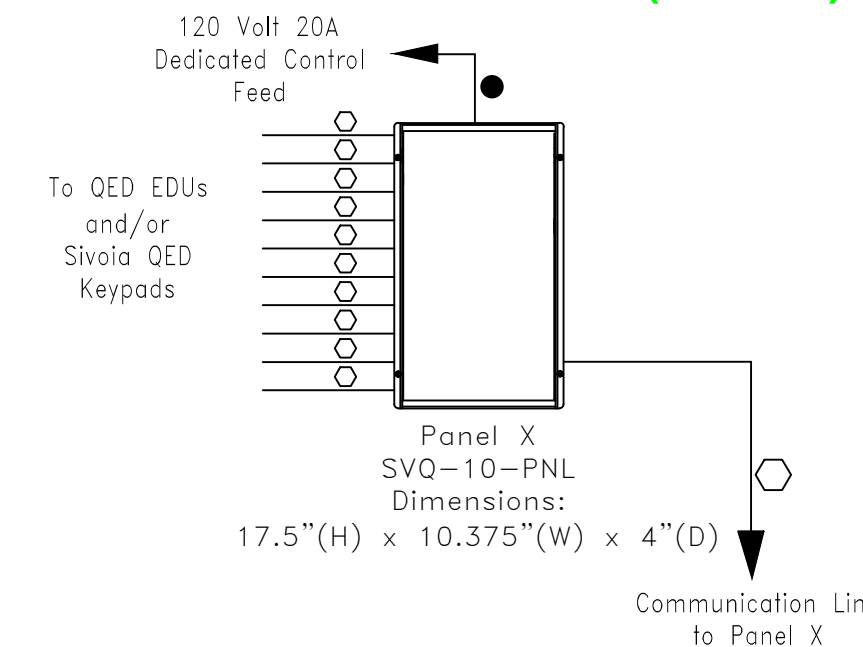

SVQ-CCI-8

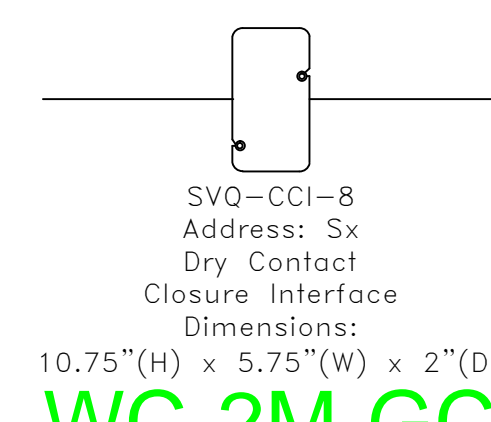

WC-2M-GC

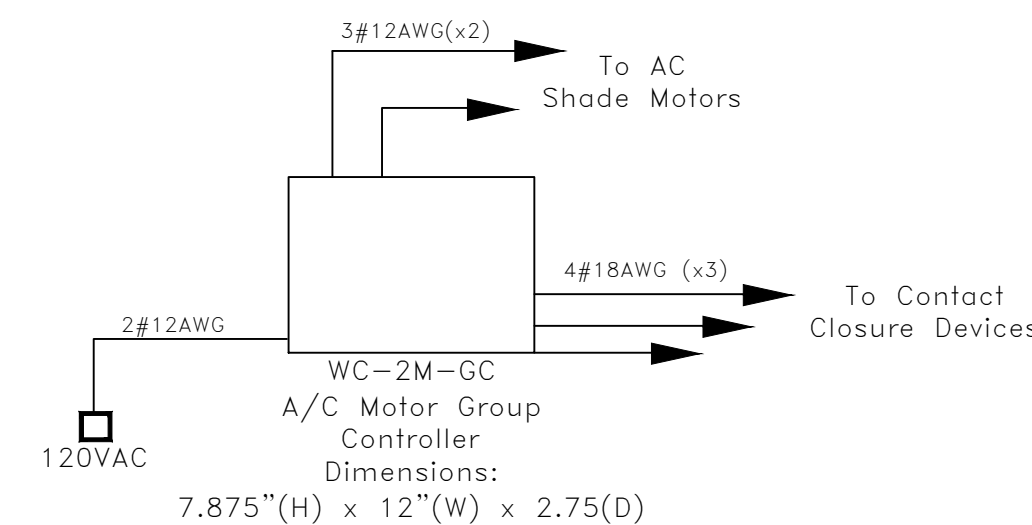

WC-4M-GC

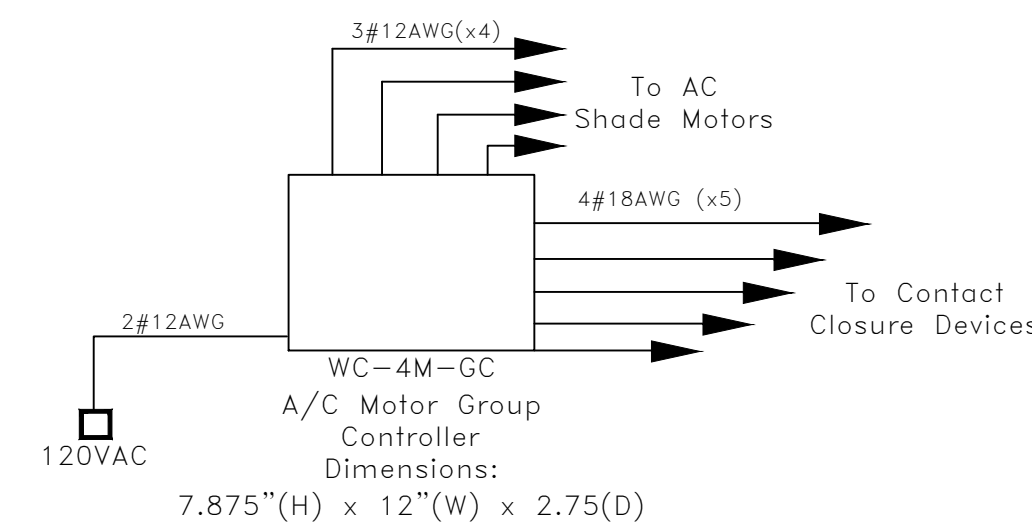

Window

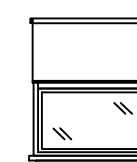

GRX-CCO-8

