

seeTouch™

Sivoia QED™ *seeTouch* Keypads

for use with *Lutron Sivoia QED* Motorized Window Treatment System

- | | |
|-------------------------------------------------|-------------------------------------------------|
| <input checked="" type="checkbox"/> SVQ-2W | <input checked="" type="checkbox"/> SVQ-2W-IR |
| <input checked="" type="checkbox"/> SVQ-2WRL | <input checked="" type="checkbox"/> SVQ-2WRL-IR |
| <input checked="" type="checkbox"/> SVQ-2WD | <input checked="" type="checkbox"/> SVQ-3W |
| <input checked="" type="checkbox"/> SVQ-3W-IR | <input checked="" type="checkbox"/> SVQ-3WRL |
| <input checked="" type="checkbox"/> SVQ-3WRL-IR | <input checked="" type="checkbox"/> SVQ-3WD |
| <input checked="" type="checkbox"/> SVQ-4WRL-IR | <input checked="" type="checkbox"/> SVQ-5WRL |

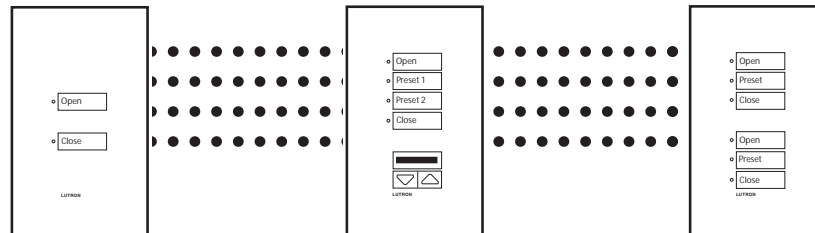

 **LUTRON**
shading solutions by **VIMCO**™

CAUTION!

- Lutron recommends that Keypads be installed by a qualified electrician.
- Do not connect high-voltage power to low-voltage terminals. **Improper wiring can result in personal injury or damage to the control or to other equipment.**
- Keypads must be connected to the *Sivoia QED* Electronic Drive Unit (EDU) by using Class 2/PELV wiring methods per the National Electrical Code®. Check with your local electrical inspector for the local code requirements and wiring practices allowed in your area.
- Use only a cloth with warm water and mild soap to clean faceplates (no chemical cleaners).

Keypad Configurations

Non-insert version shown. Insert version also available.

**SVQ-2W, SVQ-2WRL,
SVQ-2W-IR, SVQ-2WRL-IR**

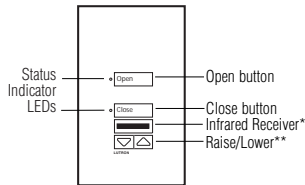

SVQ-2WD

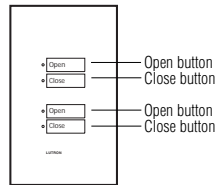

SVQ-4WRL-IR

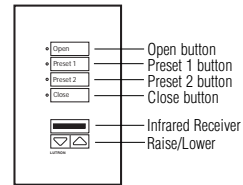

**SVQ-3W, SVQ-3WRL,
SVQ-3W-IR, SVQ-3WRL-IR**

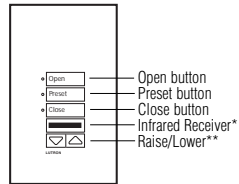

SVQ-3WD

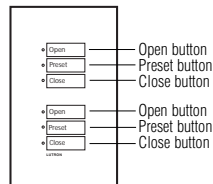

SVQ-5WRL

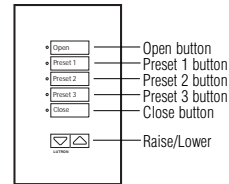

* Infrared Receiver available on SVQ-2W-IR, SVQ-2WRL-IR, SVQ-3W-IR, SVQ-3WRL-IR, and SVQ-4WRL-IR only.

** Raise and Lower buttons available on SVQ-2WRL, SVQ-2WRL-IR, SVQ-3WRL, SVQ-3WRL-IR, SVQ-4WRL-IR, and SVQ-5WRL only.

Button Functionality

Pressing the Open, Close, or Preset button will cause the window treatments to move to the selected position. While pressing the Raise or Lower button, the window treatments will raise or lower.

Open - Pressing the open button will cause the window treatments to move to the fully-open position.

Preset - Pressing one of the preset buttons (Preset 1, Preset 2, or Preset 3) will cause the window treatments to move to their programmed preset level.

Close - Pressing the close button will cause the window treatments to move to the fully-closed position.

Raise - Holding the raise button will cause the window treatments to move towards the open position. Releasing the raise button will cause the window treatments to stop.

Lower - Holding the lower button will cause the window treatments to move towards the closed position. Releasing the close button will cause the window treatments to stop.

Wiring Notes

- System Maximums:
 - Up to 64 Electronic Drive Units (EDUs) on one system. One transformer per EDU.
 - The Keypads wire to the *Sivoia QED* Communication Link. The Link can support up to 32 Keypads and can not exceed 4000 feet total.
 - The Keypads are either powered by EDUs or Keypad Power Supplies. Each EDU can provide power for one Keypad. The number of Keypads should not exceed the number of EDUs unless connecting with a Keypad Power Supply.
 - The maximum distance between any two *Sivoia QED* devices is 1000 feet unless specified otherwise.
 - Operating environment should be between 0°C - 40°C (32°F - 104°F).

Occupant Copy

3

Installation Instructions

- Keypad Wiring
 - Two #18 AWG (1.0 mm²) wires for power and two shielded #18 AWG (1.0 mm²) stranded wires for data (twisted pair). Lutron recommends and offers a one-cable, non-plenum, low-voltage cable solution (P/N SVQ-CBL-250).
 - Power: wires 1 & 2, 12 - 15 VDC.
 - Data: wires 3 & 4, twisted, shielded pair.
- *Sivoia QED* Link wiring layouts are shown on the next page.

Installation

Keypad circuits are classified as Class 2 circuits (U.S.A.) and PELV circuits (IEC). Unless otherwise specified, the voltages do not exceed 15 VDC. When installing and wiring to these Keypads, follow all applicable national and/or local wiring regulations.



Warning: Always turn Off the circuit breaker or remove the main fuse from the power line before doing any work. **Failure to do so can result in serious personal injury.**

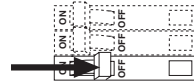

1. Turn power Off to all EDUs and power panels.
2. Mount standard U.S. 1-gang wallbox, 2.75 in. (70 mm) deep (available from Lutron P/N 241-519).
3. Strip insulation from wires so that 3/8 in. (10 mm) of bare wire is exposed for #18 AWG (1.0 mm²) wire.



Sivoia QED Link Wiring Using Power Panels

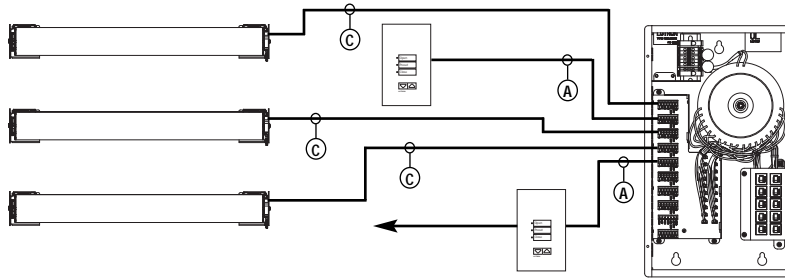

Sivoia QED Link Wiring Using Individual Transformers

For larger systems, distribute Keypads evenly on the link (maximum one Keypad between EDUs), as seen below.

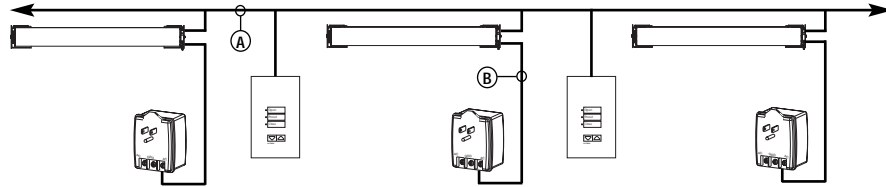

For systems with up to four Keypads and 400 feet of wire, there is no requirement for even distribution of EDUs and Keypads.

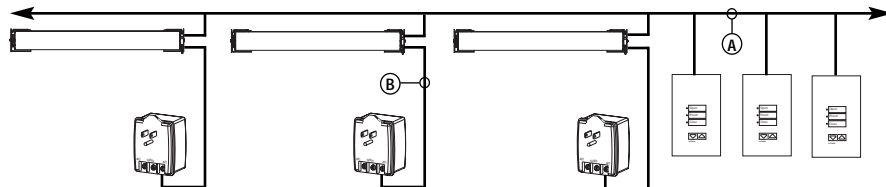

Wiring Key:

- (A) Communications Link: 4 Conductor #18 AWG (twisted and shielded)
- (B) Power Supply: 3 Conductor #16-20 AWG
- (C) SVQ-CBL-250 (A & B combined): 7 Conductors. For more information, see the *Sivoia QED* Technical Reference Guide.

- Each Keypad terminal will accept up to two #18 AWG (1.0 mm²) wires.
Connect two #18 AWG (1.0 mm²) wires to terminals 1 and 2 of the Keypad's terminal block.
Connect two #18 AWG (1.0 mm²) shielded, twisted pair wires to terminals 3 and 4 of the Keypad's terminal block.

Sivoia QED seeTouch Keypad Wiring

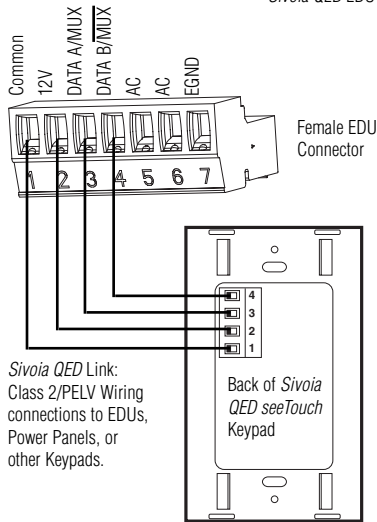
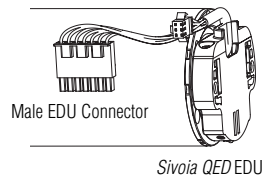

- Remove the faceplate from the Keypad. To remove the faceplate, pull outward at each corner, one corner at a time.



- Mount Keypad as shown in the diagram below.

Non-insert Version Mounting Diagram

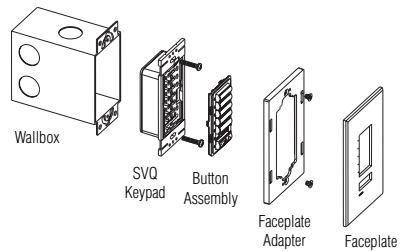

Insert Version Mounting Diagram

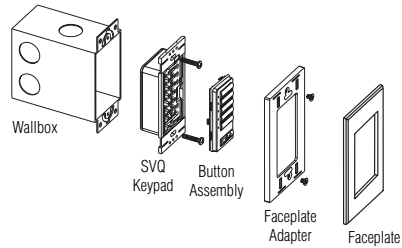

- Attach faceplate by pressing in at each corner, one corner at a time.

Addressing the System

1. Enter programming mode on the Keypad by pressing and holding the Open and Close buttons simultaneously for 5 seconds. The LEDs next to the Open and Close buttons will flash once per second, indicating the Keypad is in Programming mode.

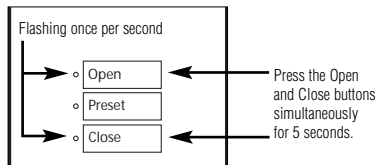

2. Initiate system addressing by pressing the Open button. The LED next to the Open button will flash quickly (8 times a second) and the LED next to the Close button will turn off. The system is now being automatically addressed.

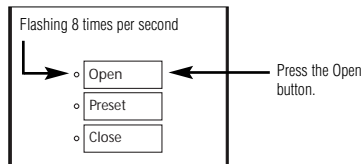

3. Wait for system addressing to be completed. This will take approximately one minute. While addressing is in progress, each Keypad will flash the Open LED quickly (8 times a second). When addressing has successfully completed, the Open and Close LEDs on each Keypad in the system will flash slowly (once per second).
4. When system addressing is complete, exit Programming mode by pressing and holding the Open and Close buttons simultaneously for 5 seconds. The Open and Close LEDs will stop flashing.

Setting Limits



Note: Entering Limit Setup mode may cause the window treatments to move approximately 8 inches up or down. **Be sure that each window treatment is positioned such that the fabric can safely move approximately 8 inches up or down before entering Limit Setup mode.**

Note: When using Keypads that do not have Raise and Lower buttons, set the limits at the EDU. Refer to the *Sivoia QED* Technical Reference Guide for more information.

1. Enter Limit Setup mode by pressing and holding the Open and Raise buttons simultaneously. The LED next to the Open button will flash once per second and the LED next to the Close button will flash quickly (8 times per second).

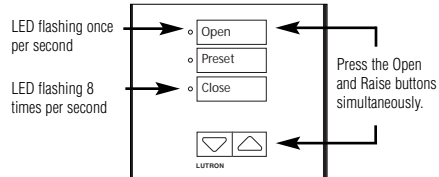

2. Select the EDU to adjust using the Open button on the Keypad. Each time the Open button is pressed and released, an EDU will begin opening and closing the window treatment over a range of approximately 8 inches. Repeat pressing the Open button until the desired EDU is selected. The Close button can also be used to select EDUs by moving through the EDUs in the opposite order.
3. Adjust the currently selected EDU to the desired level, using the Raise and Lower buttons on the Keypad.

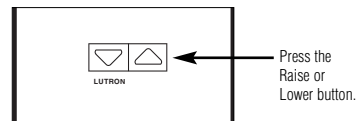

- Store the current position as the Open limit by pressing and holding the Open button on the Keypad for 5 seconds. The LED next to the Open button will turn on for two seconds.
OR
 Store the current position as the Close limit by pressing and holding the Close button on the Keypad for 5 seconds. The LED next to the Close button will turn on for two seconds.

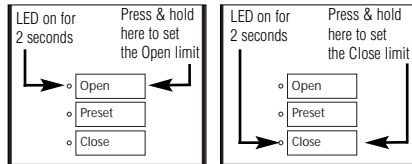

- Use the Open or Close buttons to select other window treatments and adjust the limits as in Steps 3 and 4.
- Exit Limit Set mode by pressing and holding the Open and Raise buttons simultaneously.

EDU Assignment



Note: Entering Assignment mode will cause the window treatments to move between their Open and Close limits. **Be sure that the Open and Close limits have been set appropriately.**

- Enter Programming mode on the Keypad by pressing and holding the Open and Close buttons simultaneously for 5 seconds. The LEDs next to the Open and Close buttons will flash once per second, indicating the Keypad is in Programming mode.

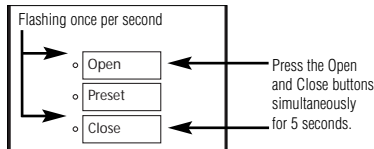

Occupant Copy

- Initiate Assignment mode by pressing the Close button. The LED next to the Close button will continue to flash (once per second) and the LED next to the Open button will turn off. EDUs that are assigned to the Keypad in Assignment Mode will move to their Close limit. EDUs that are not assigned to the Keypad will move to their Open limit.

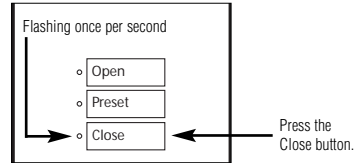

- Press any button on an EDU to toggle between assignment or unassignment with the Keypad.
OR
 Use the Open button to step through each EDU in the system. Each time the Open button is pressed, a window treatment will begin raising and lowering over approximately 8 inches. Repeat pressing the Open button until the desired EDU is selected. The Close button can also be used to select EDUs in the opposite order.

- Assign or unassign the currently selected EDU using the Raise and Lower buttons. Press the Raise button to unassign the selected EDU. Press the Lower button to assign the selected EDU.

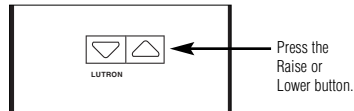

- Check assignment before exiting Assignment mode. EDUs that are at the Close limit are assigned. EDUs that are at the Open limit are unassigned.
- Exit Assignment mode by pressing and holding the Open and Close button simultaneously for 5 seconds. Each EDU will return to the level it was at when Assignment mode was entered. The Open and Close LEDs will stop flashing.

Installation Instructions

Storing Presets

Sivoia QED EDUs have the ability to store positions as presets.

1. Set all EDUs controlled by the Keypad to the desired level using the Raise and Lower buttons on the Keypad.
2. Store the EDUs' current position as a preset by pressing and holding the desired preset button for 5 seconds. The LED next to the preset button on the Keypad will flash and then turn on, indicating that the preset has been stored.

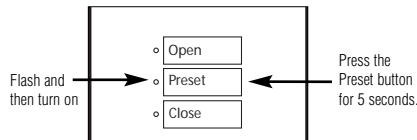

Note: The current position is stored as a preset only on the EDUs that are assigned to that preset button. The preset is only accessible from that particular Keypad.

Troubleshooting

For information on troubleshooting, please refer to the *Sivoia QED* Technical Reference Guide.

Technical Assistance

If you need assistance, call the toll free **VIMCO Technical Support Center**. Please provide exact model number when calling.
 (800) 466-1503 (U.S.A., Canada, and the Caribbean)
 Other countries call (804) 752-3300
 Fax (804) 752-3366
 Email: info@vimco.com
 Website: www.vimco.com

Limited Warranty

VIMCO will, at its option, repair or replace any unit that is defective in materials or manufacture within one year after purchase. For warranty service, return unit to place of purchase or mail to VIMCO at 11520 Sun Shade Lane, Ashland, VA 23005, postage prepaid. **This warranty is in lieu of all other express warranties, and the implied warranty of merchantability is limited to one year from purchase. This warranty does not cover the cost of installation, removal, or reinstallation, or damage resulting from misuse, abuse, or damage from improper wiring or installation. This warranty does not cover incidental or consequential damages. VIMCO's liability on any claim for damages arising out of or in connection with the manufacture, sale, installation, delivery, use, repair, or replacement of the SHADING system shall never exceed the price paid for the system.**

This warranty gives you specific legal rights, and you may also have other rights which vary from state to state. Some states do not allow the exclusion or limitation of incidental or consequential damages or limitations on how long an implied warranty may last, so the above limitation or exclusion may not apply to you.

These products may be covered under one or more of the following U.S. patents: 4,835,343; 4,924,349; D422,567; D436,930; D453,742; D456,783; D461,782; D465,460; D465,770; D466,090; D466,091; D466,484; D475,024; D475,025; and corresponding foreign patents. US and foreign patents pending.
 Lutron, the Sunburst logo, and *Sivoia* are registered trademarks and *Sivoia QED* and *seeTouch* are trademarks of Lutron Electronics Co., Inc. VIMCO and shading solutions by VIMCO are trademarks of Virginia Iron & Metal Company, Inc.
 National Electric Code is a registered trademarks of the National Fire Protection Association, Inc., Quincy, Massachusetts.
 © 2003 Virginia Iron & Metal Company, Inc.

LUTRON
 shading solutions by **VIMCO**
 VIMCO
 11520 Sun Shade Lane
 Ashland, VA 23005
 Made and printed in U.S.A.
 P/N 040-200 Rev.A 6/03