

Spacer System.slb

Spacer

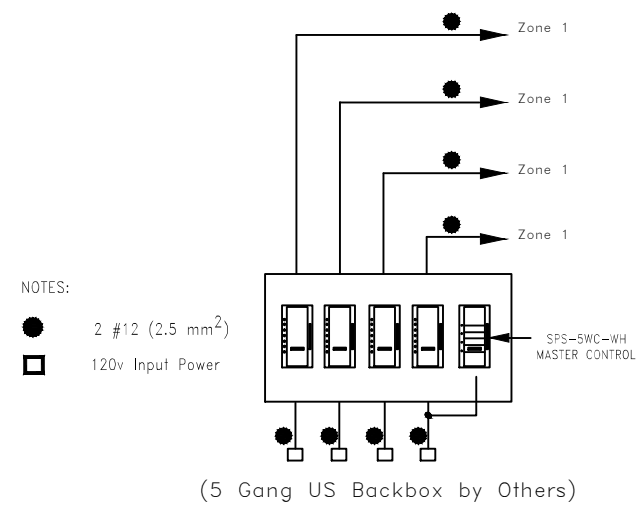

SPS-AD

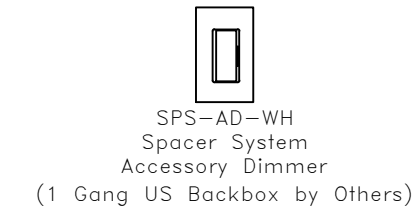

SPSF-6A

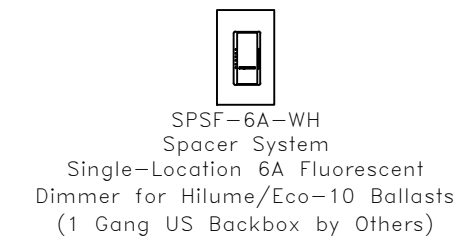

SPS-300LD

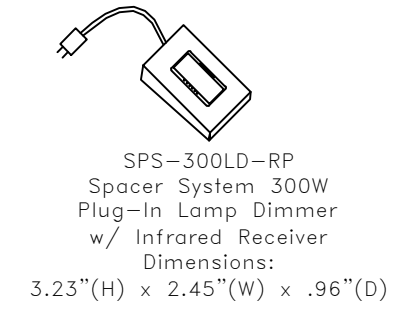

SPSF-S6A

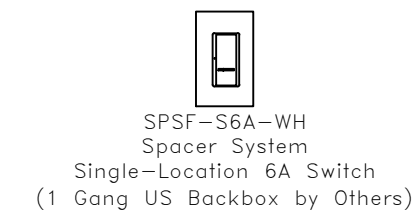

SPS-4IT

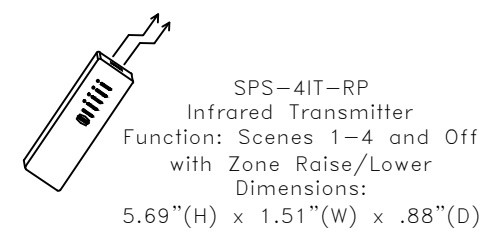

SPS-FSIT

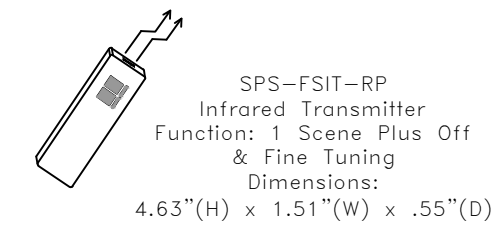

SPS-5WC

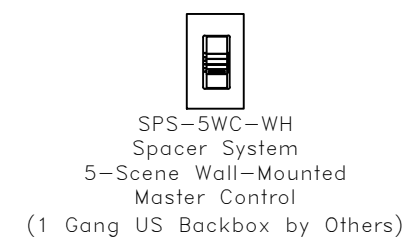

SPS-5WCR

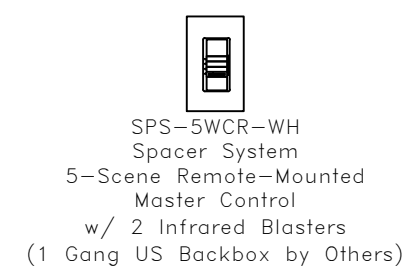

SPS-X

