

3-Wire Control 220/240 Volt T8 Linear and T-5 Twin Tube Lamps

rev eco-220-240-1b 1.10.02

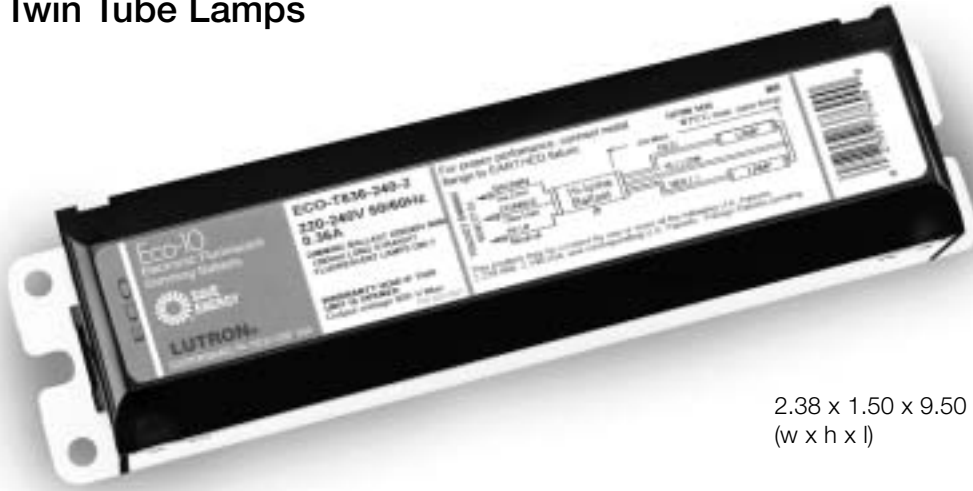

2.38 x 1.50 x 9.50 in. (60 x 38 x 241mm)
(w x h x l)

Description

- Continuous, flicker-free, 100%-10% dimming to provide lighting flexibility for a wide array of applications
- 3-wire line-voltage control technology for most consistent fixture-to-fixture dimming performance
- Low harmonic distortion throughout entire dimming range to maintain power quality
- Inrush current limiting circuitry to eliminate circuit breaker tripping, switch arcing, and relay failure
- Lamps turn on at any dimmed level without flashing to full light to eliminate nuisance flashing
- 100% performance tested prior to shipment
- 3-Year warranty
- Optional field service commissioning available – extends warranty to 5 years (limited)
- Designed and assembled in the U.S.
- Ultra quiet operation

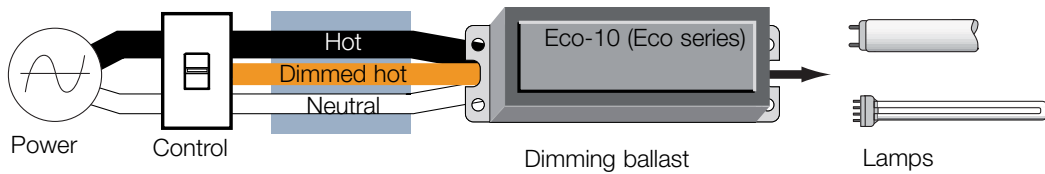

Job Name:	Model Numbers:
Job Number:	

Performance

- Dimming range: 100% - 10%
- Ballast factor greater than .85
- Total harmonic distortion less than 10%
- Power factor greater than .95
- Lamp current crest factor less than 1.6
- No visible lamp flicker
- Class A sound rating
- Continuous ballast case operating temperature 75° C
- Minimum lamp starting temperature 10° C

Standards

- UL listed, CSA approved, Class P thermally protected
- Meets ANSI C82.11 High Frequency Ballast Standard
- Meets FCC EMI/RFI emission requirements for commercial applications
- Meets ANSI C62.41 Category A surge protection standards
- ISO 9001 Certified

Eco-10 (Eco Series) Ballasts

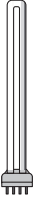
Lamps	Watts/ Length	Lamps per Ballast	Ballast Current ¹	Eco-10 (Eco) Model Number ²
 International style lamp 26 mm	18 W/600 mm	1	.10 A	ECO-T818-240-1
		2	.21 A	ECO-T818-240-2
	36 W/1200 mm	1	.20 A	ECO-T836-240-1
		2	.36 A	ECO-T836-240-2
	58 W/1500 mm	1	.25 A	ECO-T858-240-1
		2	.44 A	ECO-T858-240-2
US style lamp	32 W/1200 mm	2	.32 A	ECO-T832-240-2
 5/8 in. diameter	36 W/400 mm	1	.18 A	ECO-T536-240-1
	36 W/400 mm	2	.32 A	ECO-T536-240-2

¹For maximum number of ballasts per control, divide the control's capacity by the sum total of all ballast currents.

²Not for use in countries requiring Harmonized European Standard (CE).

Job Name:

Model Numbers:

Job Number:

Eco-10™ (Eco-Series) Linear Lamp Models

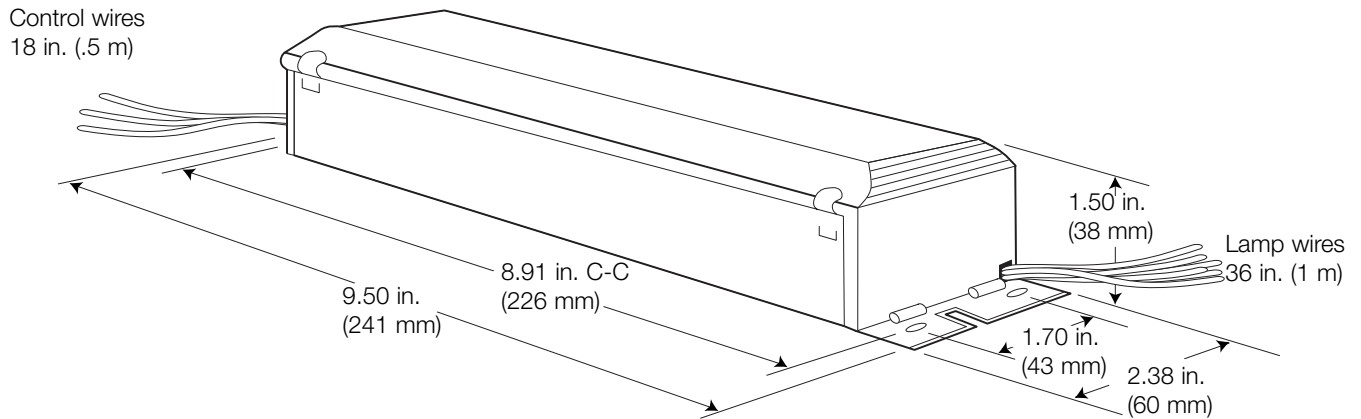

Note: For T5-HO, T8, and T12 linear lamps, maximum lamp to ballast wire length is 7 feet (2 m). For T4 Compact and T5 Twin Tube lamps, maximum lamp to ballast wire length is 3 feet (1 m).

Job Name:

Model Numbers:

Job Number:

Ballast Wiring

Note: Wire colors shown are for Lutron controls and ballasts only.

Note: For T5-HO, T8, and T12 linear lamps, maximum lamp to ballast wire length is 7 feet (2 m). For T4 Compact and T5 Twin Tube lamps, maximum lamp to ballast wire length is 3 feet (1 m).

One Lamp

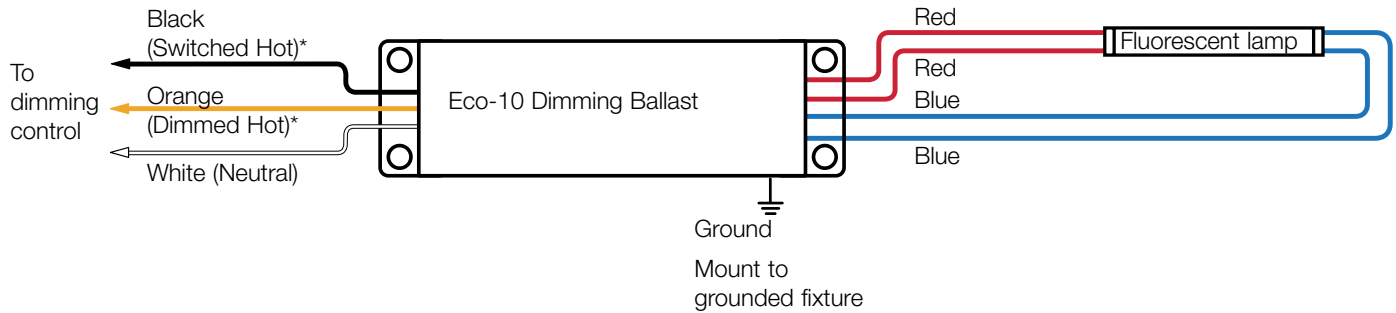

Two Lamps

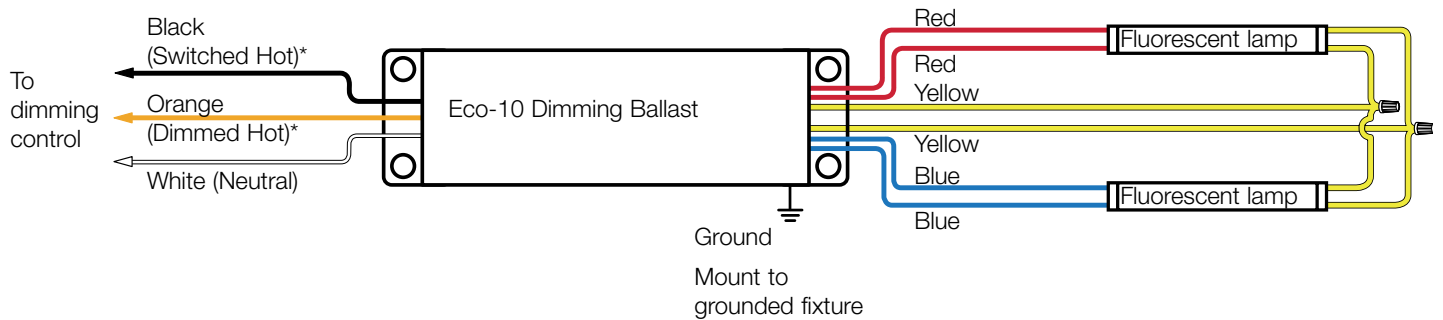

*Control wire colors do not necessarily match ballast wire colors (e.g., control “dimmed hot” may be yellow and ballast “dimmed hot” may be orange).

Job Name:	Model Numbers:
Job Number:	

Attention Specifiers

Application Notes

Perceived vs. Actual Light

An important aspect of lighting control is the difference between measured and perceived light levels. For example, a light dimmed to 10% output is perceived by the eye as 32%. A light dimmed to 1% is perceived as 10%. This “Square Law” phenomenon takes advantage of how the human eye functions to achieve significant energy savings, while improving the visual environment.

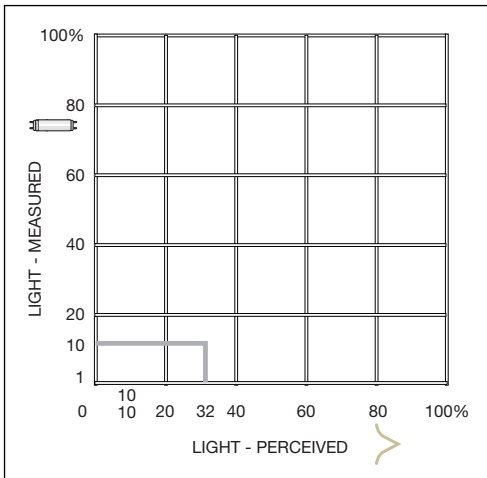

Power vs. Light

The nearly linear relationship between fluorescent light levels and power consumption saves energy proportionately as lights are dimmed.

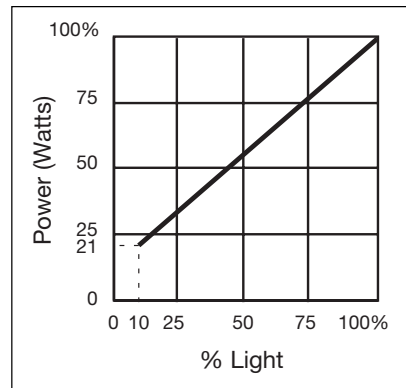

Specifications

Rapid-Start Sockets Must Be Used

Rapid-start type sockets must be used to provide proper lamp filament heating and dimming operation.

Quality knife-edge sockets are recommended for new and retrofit applications to ensure positive lamp/pin contact.

Mixing Ballast and Lamps per Circuit

For optimal dimming performance, do not mix ballast lamp types (T4, T5, T8, or T12) on a given circuit. Mixing lamp lengths (48 in., 36 in., 24 in., etc.) within a single lamp type is permissible and will not diminish dimming performance.

Do not mix ballast types on a given circuit (i.e., mix Hi-lume with Eco-10 or Tu-Wire).

Number of Ballasts per Control

For maximum number of ballasts per control, divide control's current capacity by the individual ballast current. Certain controls also have a specific number of ballast maximums.

Job Name:	Model Numbers:
Job Number:	

Attention Contractors and Electricians**Installation**Ballast/Socket Leads

Lead lengths from electronic dimming ballast to socket must not exceed 7 ft. (2 m) for T8 linear lamps.

Lamp Mounting

Many fluorescent lamp sockets are available with mounting slots to vary the height of the lamp away from the grounded metal surface. Use these slots to get the outside edge of the lamp to be 1/2 in. +/- 1/4 in. away from the grounded metal surface.

Having a fluorescent lamp too close to the grounded metal will make the minimum intensity too low and will reduce lamp life.

Having a fluorescent lamp too far away from the grounded metal will make the lamp flicker or not turn on at all.

Wiring and Grounding

All wiring from the dimming control to the Hi-lume® Ballasts is Class 1 and may be run together in the same conduit.

Ballast and lighting fixture must have a positive electrical contact with ground.

Ballasts must be installed per national and local electrical codes.

Attention Facilities Manager**Performance**Lamps Must Be Seasoned

New Lamps must be operated ("seasoned") for 100 hours at full light output prior to dimming to achieve proper dimming performance and ensure average rated lamp life.

Ballast Operating Temperature

Ballast case temperature must not exceed 75 °C at any point on ballast.

ServiceReplacement Parts

Use replacement parts with exact Lutron model numbers. Consult Lutron if you have any questions.

Further Information

Ballasts for other lamp types and voltages may be available; consult Lutron for further information.

For further information on dimming ballast applications, consult Lutron's Ballast Fluorescent Dimming Systems Guide (publication 366-606).

Job Name:	Model Numbers:
Job Number:	