

Color and Finish Codes

**EGRX-4M-\_\_-\_\_**

**4-Unit Master Wallstation**

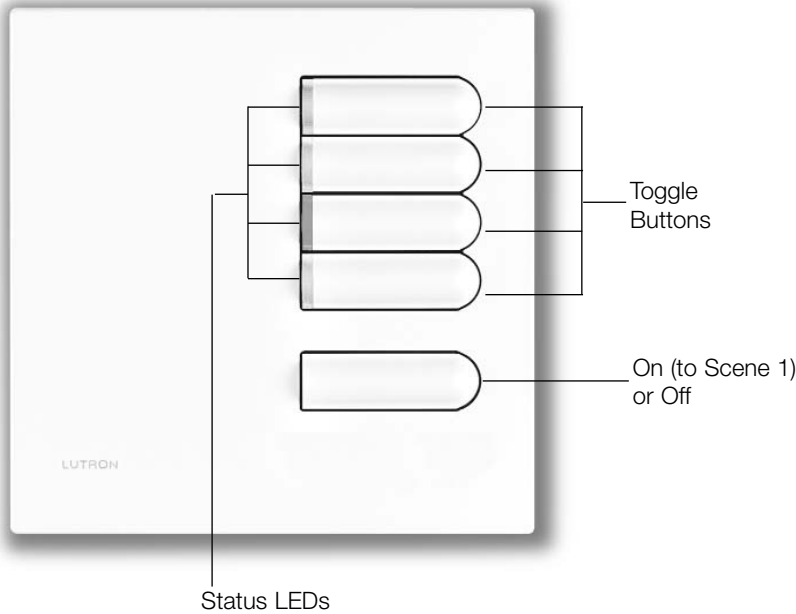



**Description**

- Allows user to control several different areas of GRAFIK Eye lighting from one master location.
- Each button can operate a different GRAFIK Eye Control Unit or group of Control Units.
- Four buttons toggle their associated Control Units on (to Scene 1) and off.
- Status LEDs indicate which Control Units are on.
- The bottom button turns all associated Control Units on (to scene 1) or off, depending on settings of DIP switches 5 and 6.
- In a home, a Master Control might be placed inside the main entry. The first button would turn on foyer lights, the second button would light a path to the kitchen, etc.
- Works with a total of eight GRAFIK Eye 3000 or 4000 Series Control Units. Control Units may be assigned to buttons in any combination.
- Mounts in UK/German wallbox. In the U.S., Lutron supplies a UK wallbox (P/N 241-683) with the Wallstation.

**Finish and Engraving Options**

Available with engraving to meet specific project needs.

**Field Selected Functionality**

DIP Switch Settings	Bottom button:
5 6	
	Turns all associated Control Units on to Scene 1.
	Turns all associated Control Units off.

 DIP Switches 7-10 are set at the factory. Do not change these switches.

<b>Job Name:</b>	<b>Model Numbers:</b>
<b>Job Number:</b>	

**Specifications**

**Power**

Low-voltage Type Class 2 (PELV).  
Operating voltage: 12/24 V Direct Current

**Key Design Features**

- Meets IEC 801-2. Tested to withstand 15kV electro-static discharge without damage or memory loss.
- Faceplate snaps on with no visible means of attachment.

**System Communications and Capacity**

- Low-voltage Type Class 2 (PELV) wiring connects Wallstations to Control Units and Control Interfaces.
- Up to 8 Control Units and up to 16 total Wallstations and/or Control Interfaces may be linked for a total of 24 control points.

**Terminals**

Accept up to two 1.0mm<sup>2</sup> (#18 AWG) wires typical.

**Environment**

0-40°C (32-104°F). Relative humidity less than 90% non-condensing.

**Color and Finish Codes**

**Standard Finishes**

Ship in 48 hours\*  
Black BL  
White WH  
Bright Brass BB  
Bright Chrome BC  
Satin Brass SB  
Satin Chrome SC

**Matte Finishes**

Ship in 3 to 4 weeks  
Ivory IV  
Beige BE  
Gray GR  
Brown BR

**Metal Finishes**

Ship in 4 to 6 weeks  
Bright Nickel BN  
Satin Nickel SN  
Antique Brass QB  
Antique Bronze QZ

**Anodized Aluminum Finishes**

Ship in 4 to 6 weeks  
Clear CLA  
Black BLA  
Brass BRA  
Engraving E  
Wallbox Included NA

Also available:  
-Custom Controls  
-Color matching  
Ship in 4 to 6 weeks. Pricing may vary depending on finish.

\* 48 hours for 4S, 2B-SL, 4SIR-8S, 8S-IR. All others – 2 weeks.

**Dimensions Front View**

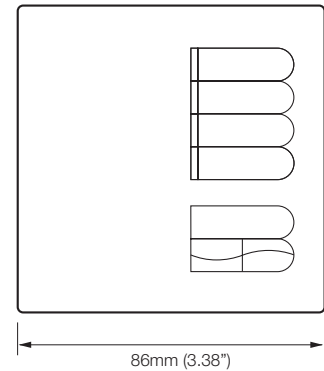

**Side View**

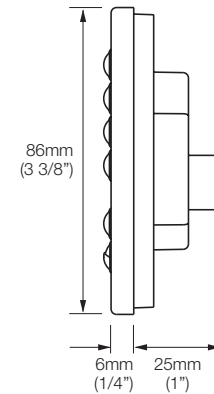

**Back View**

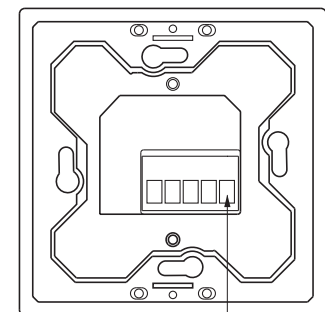

Terminals for PELV (Class 2) Wiring

**Mounting**

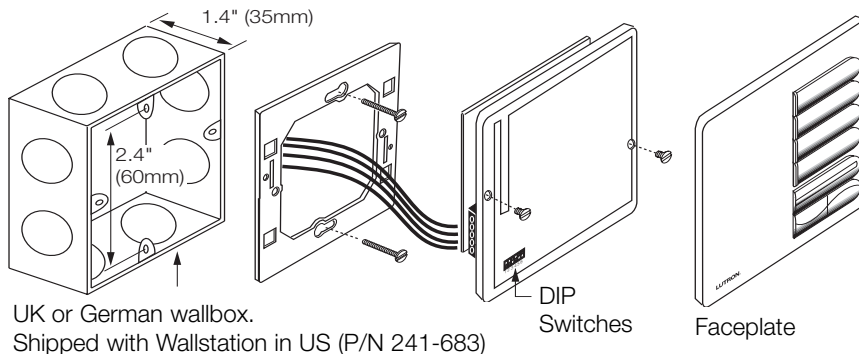

<b>Job Name:</b>	<b>Model Numbers:</b>
<b>Job Number:</b>	

## Wallstation Installation

### DIP Switches

- Set DIP switches 1-4 to give the Wallstation a unique system address from 1 to 16.
- Set additional DIP switches (if any) to specify function as shown on the first page of the Wallstation's Specification Submittal.

Address	DIP Switch Settings			
	1	2	3	4
1				
2				
3				
4				
5				
6				
7				
8				
9				
10				
11				
12				
13				
14				
15				
16				

Reserved for GRX-PRG, if present on link.

### Low-Voltage Class 2 (PELV) Wiring

- Use low-voltage Class 2 (PELV) wiring to daisy-chain Wallstations to Control Units and other components.
- Make connections inside the wallbox or in a switch/junction box with a maximum wire length of 8 feet (2.5m) from the link to the Wallstation.

Note: EGRX Wallstations have a "D" terminal for Drain. Connect the Drain/Shield at this terminal.

### When used with GRAFIK Eye 3000 Control Units:

- Two #18 AWG (1.0mm<sup>2</sup>) conductors for common (terminal 1) and 12 V Direct Current (terminal 2). Ensure that the terminal 2 connection is wired correctly. Refer to GRAFIK Eye 3000 Series Specification Submittal.
- One shielded, twisted pair #18 AWG (1.0mm<sup>2</sup>) for data link (terminals 3 and 4).

### When used with GRAFIK Eye 4000 Control Units:

- Two #12 AWG (2.5mm<sup>2</sup>) conductors for common (terminal 1) and 24 V Direct Current (terminal 2). These won't fit in terminals. Connect as shown.
- One shielded, twisted pair #18 AWG (1.0mm<sup>2</sup>) for data link (terminals 3 and 4).
- Connect Drain/Shield as shown. Do not connect to Ground (Earth). Connect the bare drain wires and cut off the outside shield.

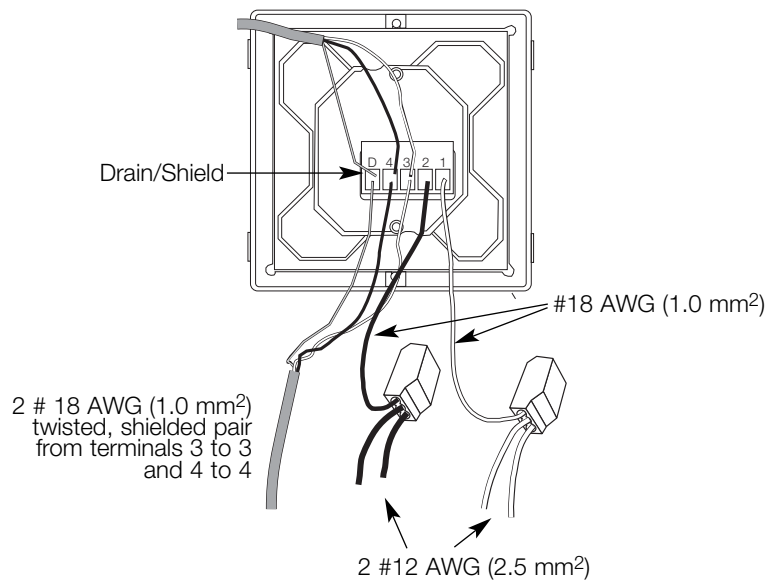

<b>Job Name:</b>	<b>Model Numbers:</b>
<b>Job Number:</b>	