

347 Volt operation 4-Wire/0-10 VDC Control T8 Linear Lamps

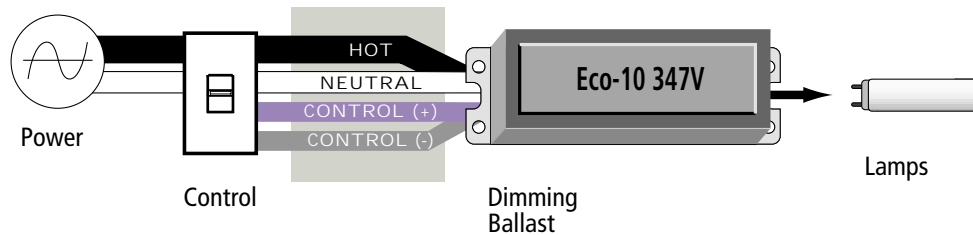

2.38" w (60mm) x 1.50" h (38mm) x 9.50" l (241mm)



DESCRIPTION

- Continuous, flicker-free, 100%-10% dimming to provide lighting flexibility for a wide array of applications
- Low-voltage 0-10VDC control technology
- Low harmonic distortion throughout entire dimming range to maintain power quality
- Inrush current limiting circuitry to eliminate circuit breaker tripping, switch arcing, and relay failure
- Lamps turn on at any dimmed level without flashing to full light to eliminate nuisance flashing
- 100% performance tested prior to shipment
- 3-Year warranty
- Optional field service commissioning available – extends warranty to 5 years (limited)
- Designed and assembled in the USA
- Ultra quiet operation

JOB NAME:	MODEL NUMBERS:
JOB NUMBER:	

PERFORMANCE

- Dimming range: 100% - 10%
- Ballast factor greater than .85
- Total harmonic distortion less than 10%
- Power factor greater than .95
- Lamp current crest factor less than 1.7
- No visible lamp flicker
- Class A sound rating
- Continuous ballast case operating temperature 75°C
- Minimum ballast starting temperature 10°C

STANDARDS

- UL listed, CSA approved, Class P thermally protected
- Meets ANSI C82.11 High Frequency Ballast Standard
- Meets FCC EMI/RFI emission requirements for commercial applications
- Meets ANSI C62.41 Category A surge protection standards
- ISO 9001 Certified

ECO-10 BALLASTS

LAMPS	WATTS/ LENGTH	LAMPS PER BALLAST	BALLAST CURRENT ¹	ECO-10 (TVE) ² MODEL NUMBER
T8 LINEAR AND U-TUBE	32W/48"	1 2	.11 .19	TVE-T832-347-1 TVE-T832-347-2
 1" Diameter				

¹ For maximum number of ballasts per circuit, divide the circuit's capacity by the sum total of all ballast currents.

² May Require Lutron Power Pack for on/off switching control.



<p>JOB NAME:</p> <p>JOB NUMBER:</p>	<p>MODEL NUMBERS:</p>
--	------------------------------

ECO-10™ 347V BALLASTS – LINEAR AND U-TUBE MODELS

(Wires exit ends of ballasts, Model Suffix-E)

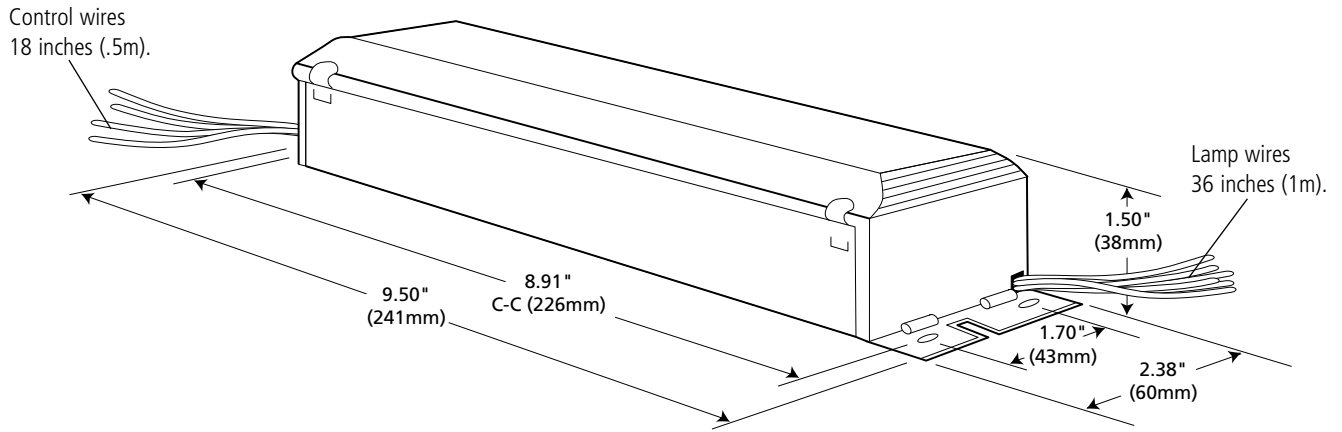

Note: For T8 linear lamps, maximum lamp to ballast wire length is 7 feet (2m).

<p>JOB NAME:</p> <p>JOB NUMBER:</p>	<p>MODEL NUMBERS:</p>
--	-----------------------

BALLAST WIRING

Note: For T8 linear lamps, maximum lamp to ballast wire length is 7 feet (2m).

Note: Wire colors shown are for Lutron controls and ballasts only.

One Lamp

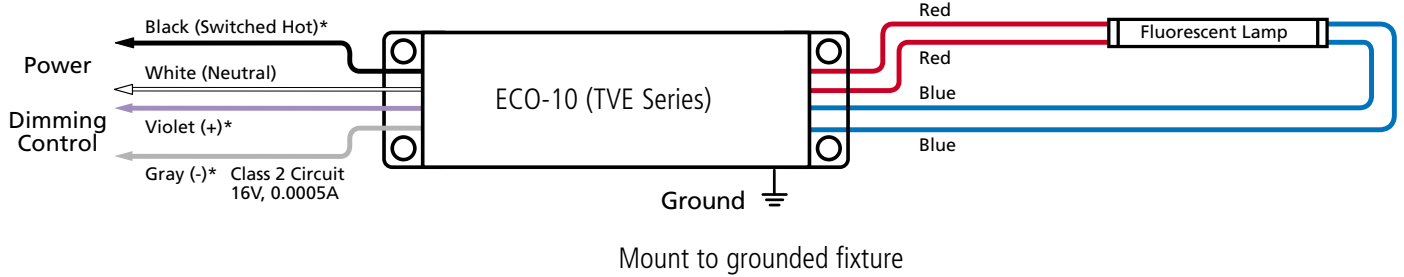

Two Lamps

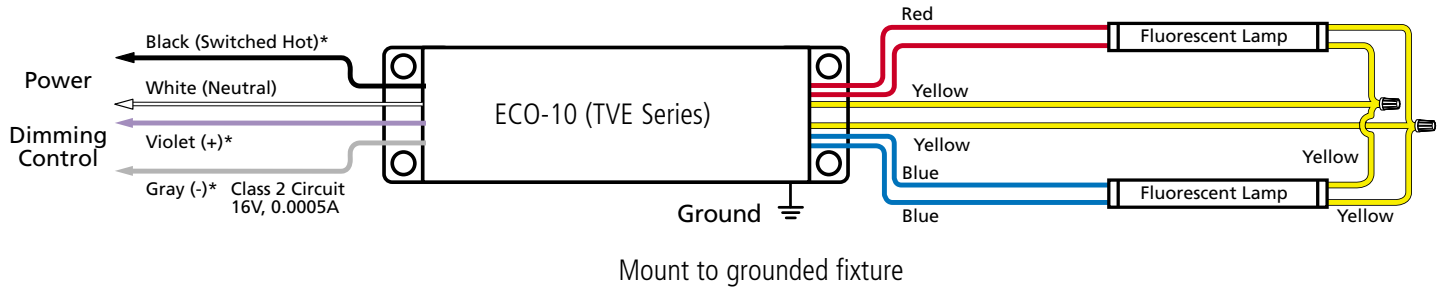

*Control wire colors do not necessarily match ballast wire colors

JOB NAME:	MODEL NUMBERS:
JOB NUMBER:	



ATTENTION SPECIFIERS:

APPLICATION NOTES

Perceived vs. Actual Light

An important aspect of lighting control is the difference between measured and perceived light levels. For example, a light dimmed to 10% output is perceived by the eye as 32%. A light dimmed to 1% is perceived as 10%. This "Square Law" phenomenon takes advantage of how the human eye functions to achieve significant energy savings, while improving the visual environment.

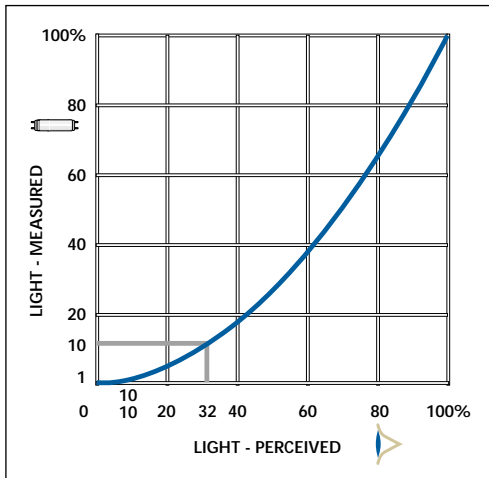

Power vs. Light

The nearly linear relationship between fluorescent light levels and power consumption saves energy proportionately as lights are dimmed.

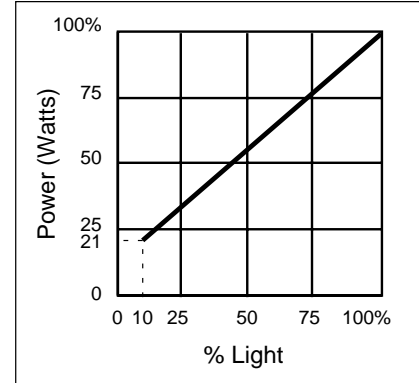

SPECIFICATIONS

Rapid-Start Sockets Must Be Used

Rapid-start type sockets must be used to provide proper lamp filament heating and dimming operation.

Quality knife-edge sockets are recommended for new and retrofit applications to ensure positive lamp/pin contact.

Mixing Ballast and Lamps per Circuit

For optimal dimming performance, do not mix ballast lamp types (T4, T5, T8, or T12) on a given circuit.

Do not mix ballast types on a given circuit (i.e., mix Hi-lume with Eco-10 or Tu-Wire).

Number of Ballasts per Control

For maximum number of ballasts per control, divide control's current capacity by the individual ballast current. Certain controls have a specific number of ballast maximums.

<p>JOB NAME:</p> <p>JOB NUMBER:</p>	<p>MODEL NUMBERS:</p>
--	------------------------------



ATTENTION CONTRACTORS AND ELECTRICIANS:

INSTALLATION

Ballast/Socket Leads

Lead lengths from electronic dimming ballast to socket must not exceed 7' (2m) for T8 linear lamps.

Lamp Mounting

Many fluorescent lamp sockets are available with mounting slots to vary the height of the lamp away from the grounded metal surface. Use these slots to get the outside edge of the lamp to be 1/2" +/- 1/4" away from the grounded metal surface.

Having a fluorescent lamp too close to the grounded metal will make the minimum intensity too low and will reduce lamp life.

Having a fluorescent lamp too far away from the grounded metal will make the lamp flicker or not turn on at all.

Wiring and Grounding

All wiring from the dimming control to the Hi-lume® Ballasts is Class 1 and may be run together in the same conduit.

Ballast and lighting fixture must have a positive electrical contact with ground.

Ballasts must be installed per national and local electrical codes.



ATTENTION FACILITIES MANAGER:

PERFORMANCE

Lamps Must Be Seasoned

New Lamps must be operated ("seasoned") for 100 hours at full light output prior to dimming to achieve proper dimming performance and ensure average rated lamp life.

Ballast Operating Temperature

Ballast case temperature must not exceed 75°C at any point on ballast.

SERVICE

Replacement Parts

Use replacement parts with exact Lutron model numbers. Consult Lutron if you have any questions.

Further Information

Ballasts for other lamp types and voltages may be available; consult Lutron for further information.

For further information on dimming ballast applications, consult Lutron's Ballast Fluorescent Dimming Systems Guide (publication 366-606).

JOB NAME:	MODEL NUMBERS:
JOB NUMBER:	