

JUNO®

Project: _____

Fixture Type: _____

Location: _____

Contact/Phone: _____

6" IC LED DOWNLIGHT REMODEL

IC22RLED RECESSED HOUSING LENSED TRIMS

PRODUCT DESCRIPTION

Dedicated LED, Air-Loc® remodel housing with integral light engine

- IC remodel housing for remodel application where back side of ceiling is not accessible
- Installs through an opening in the ceiling from below
- Secured in place by factory installed remodel springs
- Can be completely covered with insulation
- When used with supplied ALG kit, stops infiltration and exfiltration of air, reducing heating and air cooling costs
- LED housing is designed to provide 50,000 hours of life and is compatible with many standard Juno trims
- 3 year warranty.

ENVIRONMENTALLY FRIENDLY, ENERGY EFFICIENT

- No harmful ultraviolet or infrared wavelengths
- No lead or mercury
- Comparable light output to 65W BR30 incandescent while consuming 14W



PRODUCT SPECIFICATIONS

LED Light Engine Cast aluminum heat sink integrated directly with housing provides superior thermal management to ensure the long life of the LED • Replaceable PC board with quick connector mounts directly to heat sink and incorporates the latest generation of high lumen output LEDs binned to Energy Star standards • 3000K, 3500K, or 4100K color temperatures available.

Optical System Computer-optimized internal reflector with specular finish coupled with a high transmission diffusing lens conceals the LEDs and produces uniform aperture luminance.

Aesthetic Trim Selections Compatible with wide selection of existing Juno trims • Shadow free, knife edge design blends seamlessly into ceiling. • Trims are wet location approved for covered ceiling applications.

LED Driver Universal voltage driver accommodates input voltages from 120 to 277 volts AC at 60Hz • Power factor > 0.9 at 120V input • Driver has integral thermal protection • Driver is dimmable with the use of Juno qualified 120V electronic low voltage wall box dimmers.

Life Rated for 50,000 hours at 70% lumen maintenance.

Labels UL listed for damp locations • Union made AFL-CIO, UL and cUL, RoHS complaint.

Testing All reports are based on published industry procedures; field performance may differ from laboratory performance.

Product specifications subject to change without notice.

HOUSING FEATURES

Housing Designed for use in IC (insulated ceiling) or non-IC construction • .032" aluminum housing sealed for Air-Loc compliance • Remodel springs accommodate up to 1 1/8" ceiling thickness.

Junction Box Pre-wired junction box provided with (5) 1/2" knockouts and ground wire, UL listed and cUL listed for daisy chaining • Knockouts equipped with pryout slots • Push-in electrical connectors supplied as standard for fast, secure installation.

DIMENSIONS

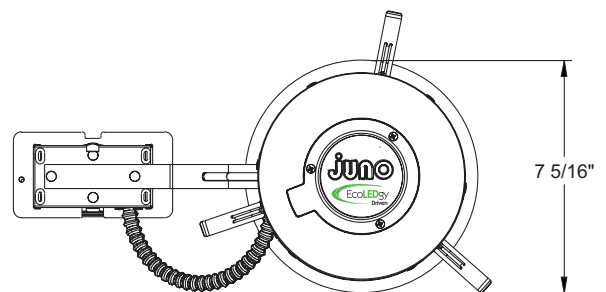
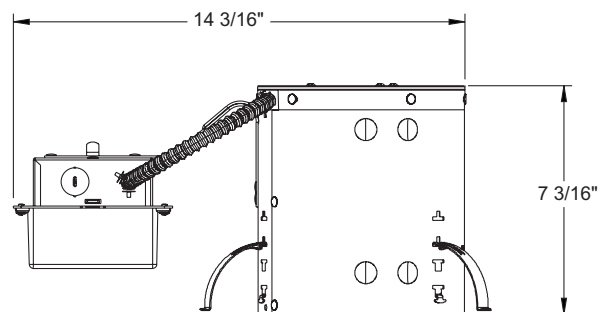

6 3/4" CEILING CUTOUT

ELECTRICAL DATA

	120V	277V
Input Power	14.2W (+/-5%)	15.4W (+/-5%)
Input Current - Max	0.128A	0.069A
Frequency	60Hz	60Hz
EMI/RFI	FCC Title 47 CFR, Part 18, Class B (consumer)	FCC Title 47 CFR, Part 18, Class A (commercial)
Minimum starting temp	-20°C (-4°F)	-20°C (-4°F)

120V APPROVED DIMMERS

Electronic low voltage dimmers require a neutral wire in the wall box.

Lutron®:

Model numbers -
Skylark® SELV-303P
Skylark® SELV-300P
Nova T☆® NTELV-600
Nova T☆® NTELV-300
Diva® DVELV-300P

Leviton®:













Model number -
Acenti® ACE06-1LW
Monet® MNE04-1LW
Vizia+® VPE04-1LZ
Vizia+® VZE04-1LX

Consult technical services or factory for additional dimmers.

6" IC LED DOWNLIGHT REMODEL

IC22RLED RECESSED HOUSING LENSED TRIMS

ORDERING INFORMATION: Housing, trim and accessories each ordered separately.

Example: IC22RLED-3K		Example: 2330W-WH	
Housing	Color Temperature Options	Trim/Description	
IC22RLED	3K 3000K 35K 3500K 41K 4100K	 20-WH 20-PW	 2330W-WH *
		 21-WH 21-PW	 2330B-WH *
		 22-WH	 6101-ABZ *
		 239-WH *	 6101-SC *
		 242-WH 242-SC 242-ABZ	 6101-WH *
		 243-WH *	 9900-WH *

UL Listed for use in wet location.
 * Do not use reflector shipped with trim for LED housing.
 Trim Size: 2330 - 7³/₈" O.D.; 239, 242, 243, 990 - 7⁷/₈" O.D.; 6101 - 7³/₄" O.D.; 20, 21, 22 - 8" O.D.;
 Trim Finish: ABZ - Classic Aged Bronze, SC - Satin Chrome, WH - White, PW - Plastic White (Polycarbonate material shower trim).
 Note: In Canada when insulation is present, Type IC fixtures must be used.
Air-Loc JUNO IC housings meet IECC Energy Code requirements per ASTM E283.
 Air-Loc® rated trims are pre-gasketed for minimum air leakage with IC housings.

PHOTOMETRIC REPORT

Test Report #: LTL14391
Catalog No: IC22RLED-35K
 with 239-WH Trim
Luminaire Spacing Criterion: 1.2
Luminaire LPW: 36.5

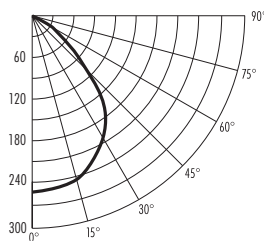

CANDLEPOWER DISTRIBUTION (Candelas)

Degrees Vertical	0°
0	253
5	252
15	247
25	225
35	171
45	102
55	55
65	32
75	18
85	5
90	0

Multiplier: 3K - 0.96
 41K - 1.03

AVERAGE INITIAL FOOTCANDLES

Multiple Units (Square Array, 60'x60' room)
Ceiling 80% Wall 50% Floor 20%

Spacing	RCR1	RCR3	RCR5
4.0'	34	30	26
5.0'	22	19	16
6.0'	15	13	11
7.0'	12	11	9
8.0'	10	8	7
9.0'	7	6	6
10.0'	5	5	4

ZONAL LUMEN SUMMARY

Zone	Lumens	%Lamp	%Fixture
0-30°	197	N/A	40.2
0-40°	303	N/A	61.9
0-60°	432	N/A	88.3
0-90°	489	N/A	100.0

INITIAL FOOTCANDLES (One Unit, 13.4W, 82.4° Beam)

Distance to Illuminated Plane (Feet)	Footcandles Beam Center	Beam Diameter
4	15.8	4.9'
6	7.0	7.4'
8	4.0	9.8'
10	2.5	12.3'

LUMINANCE (Average cd/m²)

Degrees	Average Luminance
45	8226
55	5503
65	4369
75	4039
85	3553

Fixtures tested to IES recommended standard for solid state lighting per LM-79-08. Photometric performance on a single unit represents a baseline of performance for the fixture. Results may vary in the field.



1300 S. Wolf Road • Des Plaines, IL 60018 • Phone (847) 827-9880 • Fax (847) 827-2925
 220 Chrysler Drive • Brampton, Ontario • Canada L6S 6B6 • Phone (905) 792-7335 • Fax (905) 792-0064
 Visit us at www.junolightinggroup.com