

COLOR AND ENGRAVING CODES

SG-4MN-____-____
4-Button Wallstation

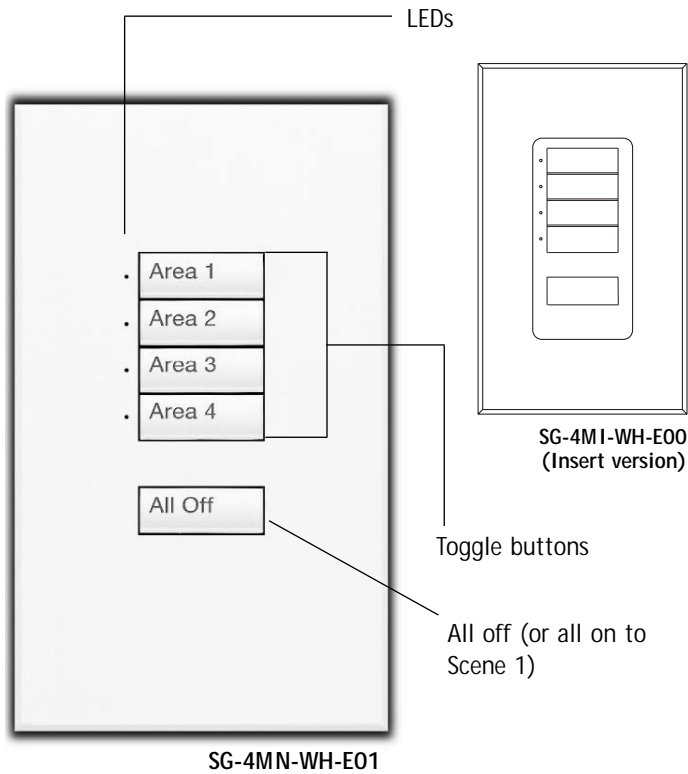

DESCRIPTION

Lets occupants control several different areas of GRAFIK Eye lighting from one master location. Each button can operate a different GRAFIK Eye Control Unit or group of Control Units.

- Large, rounded buttons are easy to touch.
- Backlit buttons with optional on-button engraving make it easy to find and operate the control in low light conditions.
- Optional on-button engraving is angled up to the eye for easy reading.
- Four toggle buttons turn their associated Control Units on (to Scene 1) and off.
- Status LEDs light up to show which Control Units are on.
- The last button either turns all associated Control Units on (to scene 1) or off, depending on how you set DIP switches 5 and 6.

For residential applications, a Master Control might be used inside the main entry. The first button would turn on foyer lights, the second button would light a path to the kitchen, and so on.

The Master Control can work with a total of eight GRX-3000 or GRX-4000 Control Units. These Control Units can be assigned to buttons in any combination.

SPECIAL FINISH AND ENGRAVING

- On-button engraving is available for improved clarity of control functions in low light conditions.
- Three engraving options are available: General Engraving, Standard Engraving, & Non-Standard Text Engraving. For more details, please refer to the *seeTouch* Ordering Guide (P/N 367-274) or visit the website at www.lutron.com/seeTouch.

FUNCTIONS

DIP SWITCH SETTINGS	The last button does this:
5 6	
	Turns all associated Control Units on to scene 1.
	Turns all associated Control Units off.



Please note: DIP Switches 7-10 are set at the factory. Consult Lutron when changing 7-9(may change functionality of control). Dip switch 10 controls the button backlight. All settings are explained in the product installation guide.

JOB NAME:	MODEL NUMBERS:
JOB NUMBER:	

SPECIFICATIONS

Power

Operating voltage: Low-voltage type Class 2(PELV), 12VDC to 24VFW.

Key Design Features

- Field-changeable button and faceplate assemblies make for easy customization.
- Front accessible DIP switches allow change of function without removing the unit from the wall.
- Meets IEC 801-2. Tested to withstand 15kV electro-static discharge without damage or memory loss.
- Has faceplate that snaps on with no visible means of attachment.
- Available as an "insert" style control for multi-ganging.
- Can be ganged to share a common faceplate with NovaT☆ and Vareo Dimmers. To order new Wallplates for multi-ganging, specify "R3" openings in a Lutron NovaT multi-gang FB (fins broken) Series model number.
- Use Button Replacement Kits to change color, button configuration, engraving, or between insert and non-insert versions.
- Button Replacement Kits may also be used to convert between non-insert and insert configurations.

System Communications and Capacity

- Low-voltage type Class 2 (PELV) wiring connects Wallstations to Control Units and other components.
- You can link up to 8 Control Units and up to 16 total Wallstations and/or Control Interfaces for a total of 24 control points.

Terminals

Capacity: Accept up to two #18 AWG (1.0mm²) typical.

Environment

32-104°F (0-40°C). Relative humidity less than 90% non-condensing.

MOUNTING- Typical backbox dimensions: 95mm (3.74") high, 55mm (2.17") wide, 70mm (2.75") deep.

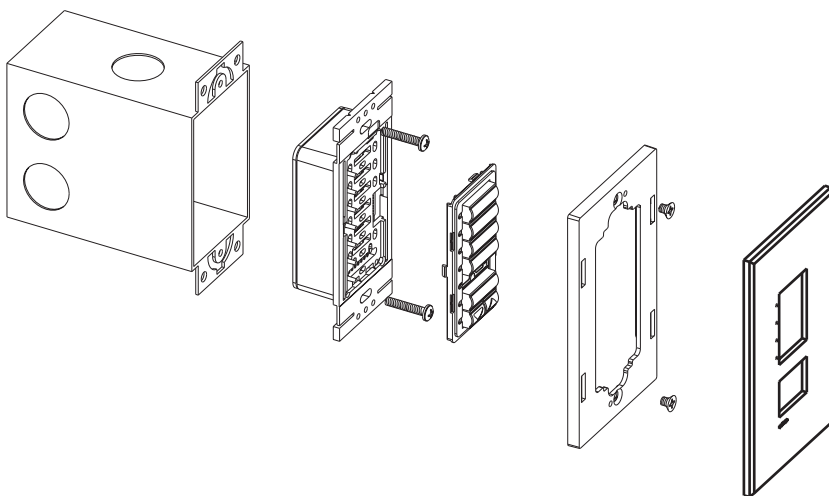

DIMENSIONS

Front View

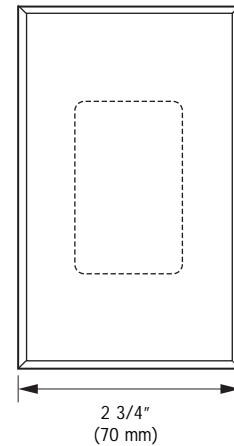

Side View

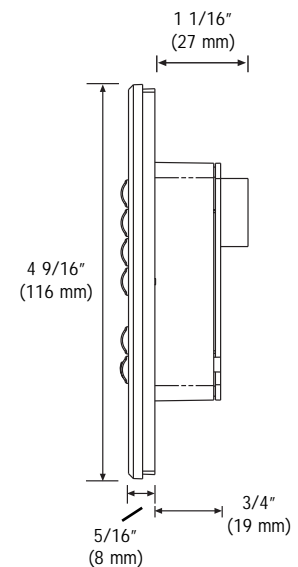

Back View

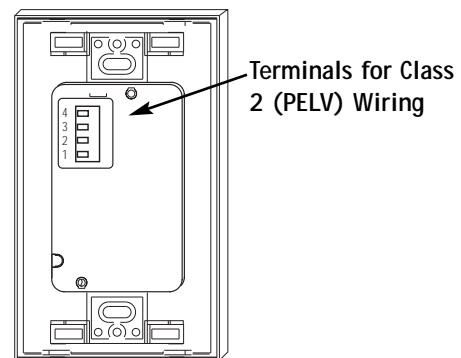

JOB NAME:	MODEL NUMBERS:
JOB NUMBER:	

Color/Finish and Customizing Information

COLORS/FINISH

Matte Finishes

White	WH
Ivory	IV*
Beige	BE
Gray	GR*
Brown	BR
Black	BL

* GR, IV not currently backlighted

Metal Finishes

(Standard with Black Plastic Buttons)

Bright Brass	BB
Bright Chrome	BC
Bright Nickel	BN
Satin Brass	SB
Satin Chrome	SC
Satin Nickel	SN
Antique Brass	QB
Antique Bronze	QZ

Gloss Finishes

(Available with Insert (I) style controls only; ship with Claro® style faceplates)

White	GWH
Light Almond	GLA

Anodized Aluminum

Clear	CLA
Black	BLA
Brass	BRA

Backlighting Notes:

Illuminated text (translucent text on buttons) is available for these colors: BL and BR (also applies to all metal finishes).

Illuminated buttons (with black text on buttons) are available for these colors/finishes: WH, BE, GR, GWH*, GLA*.

* Insert (I) style controls only

MULTI-GANGING

1. Order Insert (I) style controls.
2. To order new Wallplates for multi-ganging, specify "R3" openings in a Lutron NovaT multi-gang FB (fins broken) Series model number.

Examples:

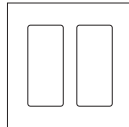

Wallplate for 2 Seetouch Wallstations, Model # **NT-R3-R3-FB**-(color)

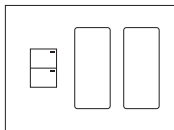

Wallplate for other Lutron controls and 2 Seetouch Wallstations, Model # **NT-T8-R3-R3-FB**-(color)

Note: New button inserts are **not** included with multi-ganging Wallplates.

BUTTON REPLACEMENT KITS

Use Button Replacement Kits to change: colors, button configuration, engraving, between insert and non-insert versions.

Non-Insert Kit

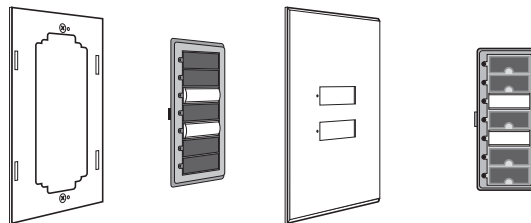

Each Kit includes an adapter, button assembly, and wallplate

Insert Kit

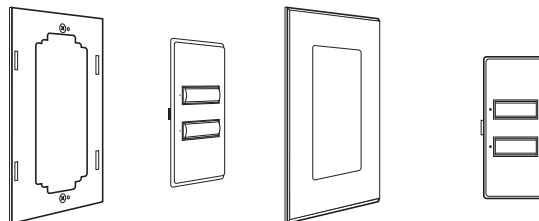

JOB NAME:	MODEL NUMBERS:
JOB NUMBER:	

Wallstation Installation

DIP SWITCHES

- Set DIP switches 1-4 to give the Wallstation the unique system address from 1 to 16.
- Set additional DIP switches (if any) to specify function as shown on the first page of the Wallstation's Specification Submittal.
- Dip switch 10 controls the button backlight.

Address	DIP SWITCH SETTINGS			
	1	2	3	4
1	↑	↑	↑	↑
2	↑	↑	↑	↓
3	↑	↑	↓	↑
4	↑	↑	↓	↓
5	↑	↓	↑	↑
6	↑	↓	↑	↓
7	↑	↓	↓	↑
8	↑	↓	↓	↓
9	↓	↑	↑	↑
10	↓	↑	↑	↓
11	↓	↑	↓	↑
12	↓	↑	↓	↓
13	↓	↓	↑	↑
14	↓	↓	↑	↓
15	↓	↓	↓	↑
16	↓	↓	↓	↓

Reserved for GRX-PRG, if present on link.

LOW-VOLTAGE CLASS 2 (PELV) WIRING

- Use low-voltage Class 2 (PELV) wiring to daisy-chain Wallstations to Control Units and other components.
- Make connections inside the wallbox. Or in a switchbox or junction box with a maximum wire length of 8 feet (2.5m) from the link to the Wallstation.

Note: EGRX Eurostyle Wallstations have a D terminal for Drain. You can connect the Drain/Shield at this terminal.

When used with GRX-3000 Control Units

- Two #18 AWG (1.0mm²) conductors for common (terminal 1) and 12VDC (terminal 2). Make sure you wire the terminal 2 connection correctly. Refer to GRX-3000 Specification Submittal.
- One shielded, twisted pair #18 AWG (1.0mm²) for data link (terminals 3 and 4).

When used with GRX-4000 Control Units

- Two #12 AWG (2.5mm²) conductors for common (terminal 1) and 24VFW (terminal 2). These won't fit in terminals. Connect as shown.
- One shielded, twisted pair #18 AWG (1.0mm²) for data link (terminals 3 and 4).
- Connect Drain/Shield as shown.
 - Do not connect to Ground (Earth) or Wallstation.
 - Connect the bare drain wires and cut off the outside shield.

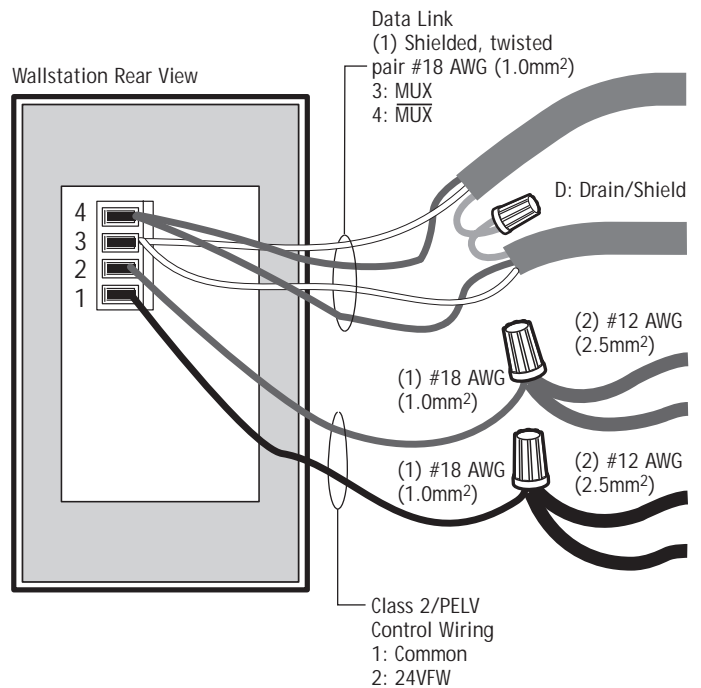

JOB NAME:	MODEL NUMBERS:
JOB NUMBER:	