

# HOMEWORKS™ Coordinating Accessories

## NT-, NTR-

### LUTRON SPECIFICATION SUBMITTAL

Job Name		Job Number			
Location					
Model No. NT-, NTR-	Color	<input type="checkbox"/> White	<input type="checkbox"/> BEige	<input type="checkbox"/> Ivory	<input type="checkbox"/> GRay
		<input type="checkbox"/> BRown	<input type="checkbox"/> BLack	<input type="checkbox"/> TauPe	<input type="checkbox"/> Dusty Rose

## Vareo Style Coordinating Accessories

### Receptacles

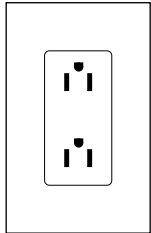

**NTR-15-**  
15 Amp, 125V

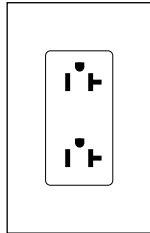

**NTR-20-**  
20 Amp, 125V

### Phone / Cable Jack<sup>2</sup>

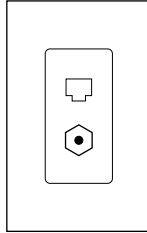

**NT-PJ8CJ-**  
8 conductor, category 5  
75 Ohm, coaxial cable

### Cable TV Jack<sup>2</sup>

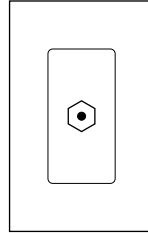

**NT-CJ-**  
F style, 75 Ohm  
coaxial cable

### The Finishing Touch

HomeWorks coordinating accessories unify the look of the home's phone jacks, cable jacks and receptacles with Vareo, Lutron's premier wallbox line. The coordinating accessories feature automatic multigang alignment for quick and easy installation.

### GFCI Receptacles<sup>1</sup>

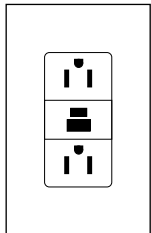

**NTR-15-GFCI-**  
15 Amp, 125V

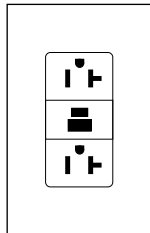

**NTR-20-GFCI-**  
20 Amp, 125V

### Telephone Jack<sup>2</sup>

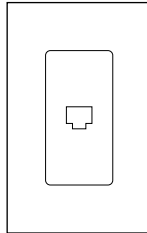

**NT-PJ-**  
6 conductor

### Dual Phone Jack<sup>2</sup>

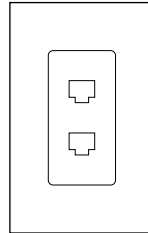

**NT-PJ8X2-**  
8 conductor each jack  
category 5

### Triple Phone Jack<sup>2</sup>

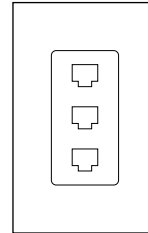

**NT-PJ8X3-**  
8 conductor each jack  
category 5

### Isolated Ground Receptacles

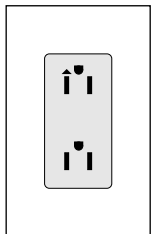

**NTR-15-IG-**  
15 Amp

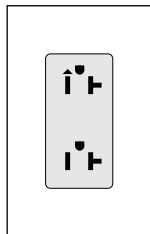

**NTR-20-IG-**  
20 Amp

### Dimensions for Accessories

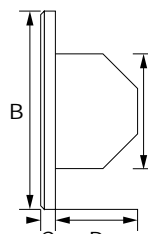
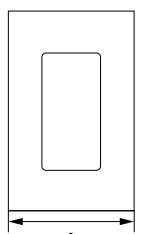

	Inches	mm
A	2.75	70.0
B	4.50	114.0
C	.30	7.5
D	1.31	32.7†
E	2.75	70.0

† some models up to 1.71" (43.4 mm)



Lutron Electronics Co., Inc.  
7200 Suter Road  
Coopersburg, PA 18036, USA  
8/97 P/N 366-556

- GFCI receptacles are only available in white, ivory, gray, brown, black, bright chrome, bright brass and satin brass.
- A physical barrier (partition) must exist when ganging with 120V products.

For additional submittal sheets, call our Hot Line and Fax-on-Demand Service at 1-800-523-9466, or visit Lutron's Web site at <http://www.lutron.com/resi>

## HomeWorks Accessories Wiring Diagrams

Wiring diagram for NTR-15-GFCI- & NTR-20-GFCI-

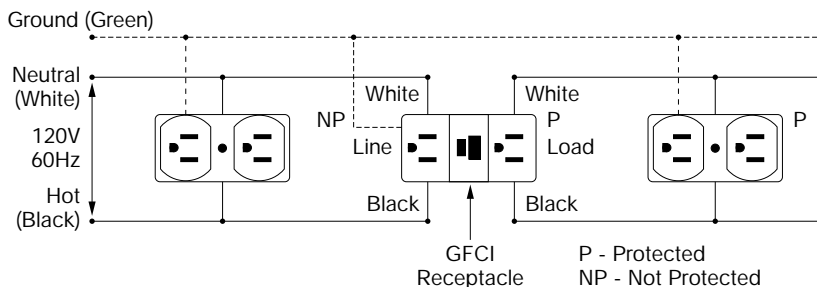

Wiring diagram for NTR-15-,  
NTR-20-, NTR-15-IG- & NTR-20-IG-

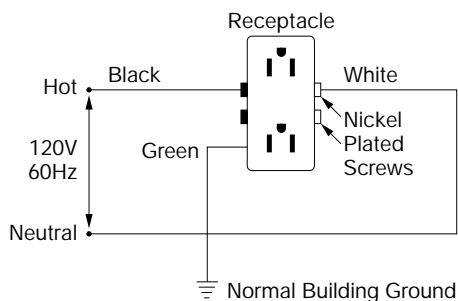

Wiring diagram for NTR-15-,  
NTR-20-, NTR-15-IG- & NTR-20-IG-

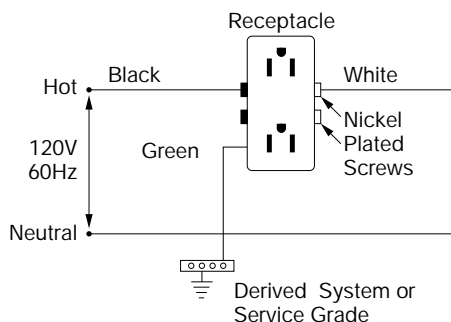

Wiring table for NT-PJ

Jack Position	Wire Color
1	white
2	black
3	red
4	green
5	yellow
6	blue

Wiring table for NT-PJ8X2-, NT-PJ8X3- & NT-PJ8CJ-

AT&T T568B	Wire Color	ISDN T568A	Wire Color
5	white-blue	5	white-blue
4	blue	4	blue
1	white-orange	3	white-orange
2	orange	6	orange
3	white-green	1	white-green
6	green	2	green
7	white-brown	7	white-brown
8	brown	8	brown

### Receptacles and Jacks

- 1(a). Receptacles shall be Lutron NovaT<sup>®</sup> style with two-pole three-wire ground and rated 15A or 20A at 125V. Configuration shall be of this duplex type with rectangular design.
- 1(b). Isolated Ground Receptacles shall be Lutron NovaT<sup>®</sup> style with two-pole three-wire ground and rated 15A or 20A at 125V. Configuration shall be of the duplex type with rectangular design. Receptacle's face shall be orange with black isolated ground triangle or standard NovaT<sup>®</sup> colors with orange isolated ground triangle.

2. Ground-fault interrupter receptacles shall be NovaT<sup>®</sup> style with two-pole, three-wire ground and rated to 15A or 20A at 125V. Receptacles shall have a 5 milliamperere ground-fault trip level with "test" and "reset" buttons.
3. Telephone jacks shall be Lutron NovaT<sup>®</sup> style designed to mate with standard six-conductor plugs and shall meet FCC Part 68, paragraph-F standards to ensure compatibility with U.S. telephone systems.
4. Eight-conductor telephone jacks shall be Category 5 Voice and Data rated. They shall be FCC Part 68, Sub-part F compliant.

### Warranty

Lutron will, at its option, repair or replace any control that is defective in materials or manufacture within two years after the purchase.

This warranty is in lieu of any other warranties, express or implied, and the implied warranty of merchantability is limited to two years from purchase.

This warranty does not cover the cost of installation, removal or reinstallation, or damage resulting from misuse, abuse, or improper wiring or insulation.

This warranty gives you specific legal rights, and you may also have other rights which vary from state to state. Some states do not allow the exclusion or limitation of incidental or consequential damages, or limitations on how long an implied warranty may last, so the above limitations and exclusions may not apply to you.

Printed in U.S.A.

© 1997 Lutron Electronics Co., Inc.