

Color and Engraving Codes

SO-3BON-___ - ___

SO-3BOI-___ - ___

3-Button Wallstation with Occupant Sensor Connection

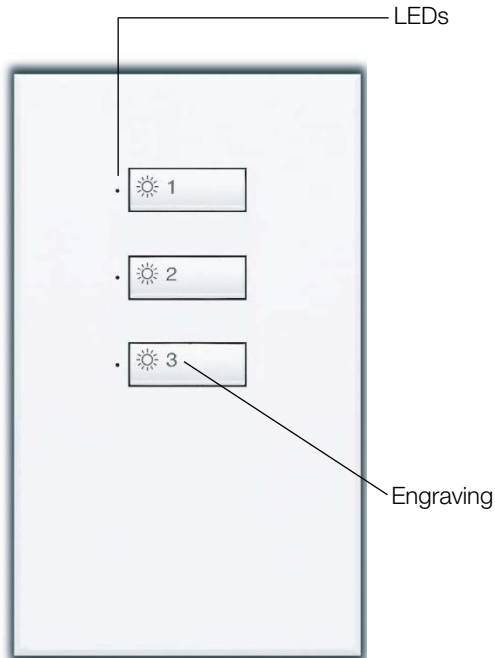

SO-3BON-WH-EGN
(Non-insert version)

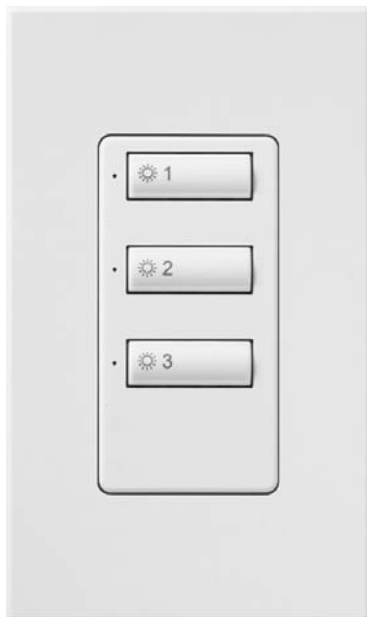

SO-3BOI-WH-EGN
(Insert version)

Description

- Used to select scenes.
- Supplies power to and receives a control signal from an Occupant Sensor via a connector on the back of the Wallstation.
- Large, rounded buttons are easy to use.
- Backlit buttons with optional engraving make it easy to find and operate the Wallstation in low light conditions.
- Optional button engraving is angled up to the eye for easy reading.
- Recalls preset light levels for scenes.
- Reflects door status of partitions.
- May be custom-configured for other functions.
- Works with GRAFIK 5000™, GRAFIK 6000®, GRAFIK 7000™, Softswitch128™, and Softswitch512™ Systems.

Finish and Engraving Options

- Available with button engraving.
- Three engraving options are available: General Engraving, Standard Engraving, & Non-Standard Text Engraving. For more details, visit the *seeTouch* website at www.lutron.com/seetouch.

Job Name:

Model Numbers:

Job Number:

Specifications

Power Input (Control Link Terminal 2)

Low-voltage type PELV (Class 2: USA). Operating voltage: 24 V_{DC}

Key Design Features

- Field-changeable button and faceplate assemblies allow easy customization.
- Front accessible address and option switches allow change of function without removing the unit from the wall.
- Meets IEC 801-2. Tested to withstand 15kV electro-static discharge without damage or memory loss.
- Faceplate snaps on with no visible means of attachment.
- Available as an “insert” style control for multi-gangung.
- Can be ganged to share a common faceplate with NovaT*® and Vareo® Dimmers. To order new Wallplates for multi-gangung, specify “R3” openings in a NovaT* multi-gang FB (fins broken) Series model number.
- Use Faceplate Replacement Kits to change color, button configuration, or engraving.
- Faceplate Replacement Kits may also be used to convert between non-insert and insert configurations.

System Communications and Capacity

- Low-voltage type PELV (Class 2: USA) wiring connects Wallstations to Processor Panel on the Control Station Device (CSD) Link.
- Counts as one Control Station Device (CSD).

Terminals

Accept up to two #18 AWG (1.0mm²) typical.

Environment

32-104°F (0-40°C). Relative humidity less than 90% non-condensing.

Mounting

Typical backbox dimensions: 3.74” (95mm) high, 2.17” (55mm) wide, 2.75” (70mm) deep.

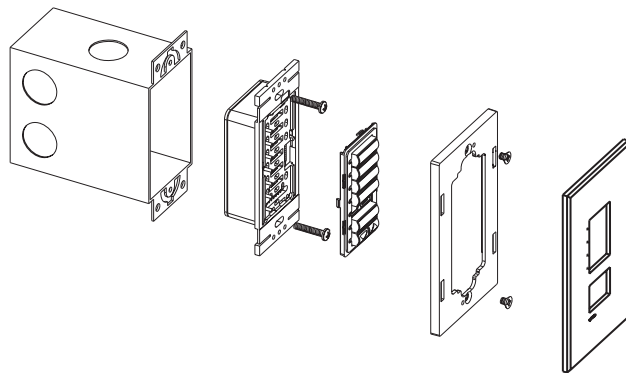

Dimensions

Front View

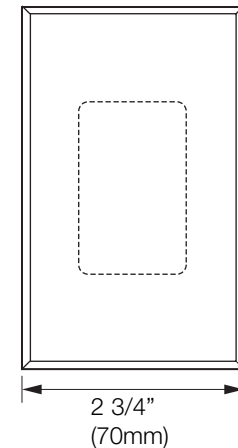

Side View

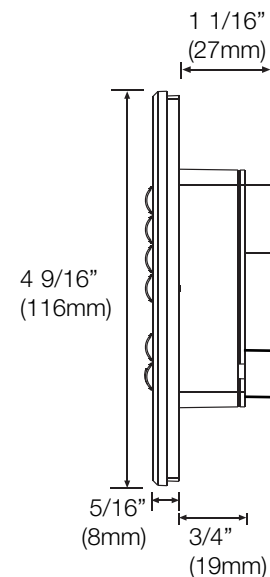

Back View

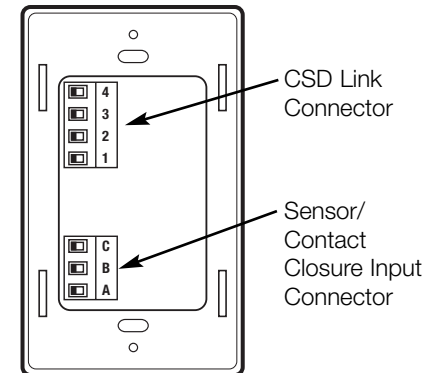

Job Name:

Model Numbers:

Job Number:

How to Build a seeTouch Model Number

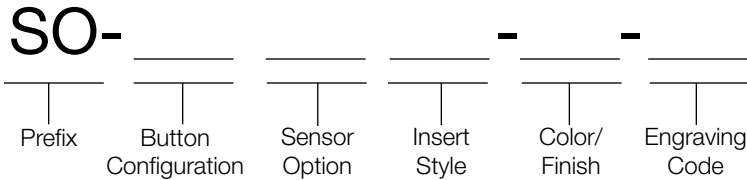

Omit: CCI
O: Occupant sensor

N: Non-insert
I: Insert

Color/Finish Codes

Matte Finishes		Satin Colors™	
White	WH	Available with Insert (I) style controls only.	
Ivory	IV	Snow	SW
Beige	BE	Biscuit	BI
Gray	GR	Eggshell	ES
Brown	BR	Midnight	MN
Black	BL	Blue Mist	BT*
Taupe	TP	Limestone	LS*
		Stone	ST*
		Desert Stone	DS*
		Terracotta	TC*
		Ochre	OC*
		Hot	HT*

Gloss Finishes
Available with Insert (I) style controls only. Ship with Claro® Wallplates.

White	GWH
Light Almond	GLA

Metal Finishes
With black plastic buttons (standard).

Bright Brass	BB
Bright Chrome	BC
Bright Nickel	BN
Satin Brass	SB
Satin Chrome	SC
Satin Nickel	SN
Antique Brass	QB
Antique Bronze	QZ

Anodized Aluminum Finishes
With black plastic buttons (standard).

Clear	CLA
Black	BLA
Brass	BRA

*Note: Some *Satin Colors* units ship with different color buttons. For more information, please visit the [seeTouch](http://www.lutron.com/seetouch) website at www.lutron.com/seetouch.

Engraving Codes

Unengraved	E00
------------	-----

General/Standard Engraving

Arabic	Axx
Portug. (Latin)	Bxx
Chinese	Cxx
Danish	Dxx
English	Exx
French	Fxx
German	Gxx
Italian	Ixx
Japanese	Jxx
Spanish (Latin)	Lxx
Dutch	Nxx
Portug. (Euro)	Pxx
Spanish (Euro)	Sxx

Note: Replace the xx with either GN (general engraving) or a two-digit number (01-99; standard engraving). Please visit the [seeTouch](http://www.lutron.com/seetouch) website at www.lutron.com/seetouch for a listing of the standard engraving choices.

Non-Standard Text Engraving
Customized button engraving for particular needs. Use with Faceplate Replacement Kits only (model number begins with SR). Use an engraving code of NST. To order, contact Lutron customer service. Please visit the [seeTouch](http://www.lutron.com/seetouch) website at www.lutron.com/seetouch for custom engraving sheets.

Job Name:	Model Numbers:
Job Number:	

Faceplate Information

Multi-ganging

- Order Insert (I) style controls.
- To order Wallplates for multi-ganging, specify “R3” openings in a NovaT*® multi-gang FB (fins broken) Series model number.

Examples:

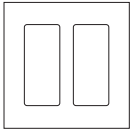

Wallplate for 2 *seeTouch* Wallstations,
Model # NT-R3-R3-FB-(color)

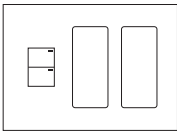

Wallplate for other *Lutron* controls and 2 *seeTouch* Wallstations,
Model # NT-T8-R3-R3-FB-(color)

- Order Claro® Wallplates for multi-ganging Wallstations in Gloss Finishes.
- Order Satin Colors™ Wallplates for multi-ganging Wallstations in *Satin Colors*.

Note: New button inserts are not included with multi-ganging Wallplates.

Wallstation Installation

Control Station Device (CSD) Link Wiring

- Use low-voltage PELV (Class 2: USA) wiring to daisy-chain Wallstations to the Processor Panel.
- Make connections inside the wallbox or in a switch/junction box with a maximum wire length of 8 feet (2.5m) from the link to the Wallstation.
- Two #12 AWG (2.5mm²) conductors for common (terminal 1) and 24 V_{AC} (terminal 2). These will not fit in terminals. Connect as shown.
- One shielded, twisted pair #18 AWG (1.0mm²) for data link (terminals 3 and 4).
- Connect Drain/Shield as shown. Do not connect to Ground (Earth) or Wallstation. Connect the bare drain wires and cut off the outside shield.

Note: Some Wallstations have a “D” terminal for Drain. The Drain/Shield wire may be connected to this terminal.

Faceplate Replacement Kits

Use Faceplate Replacement Kits to change: colors, button configuration, engraving, between insert and non-insert versions. Each Kit includes an adapter, button assembly, and wallplate

Non-Insert Kit

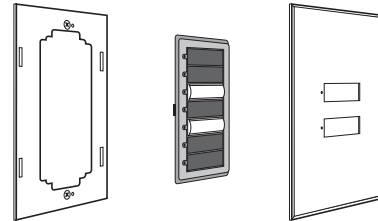

Insert Kit

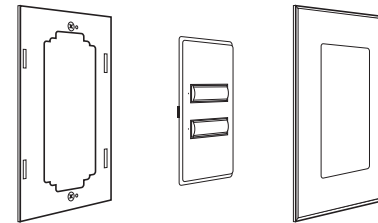

Wiring to Control Link

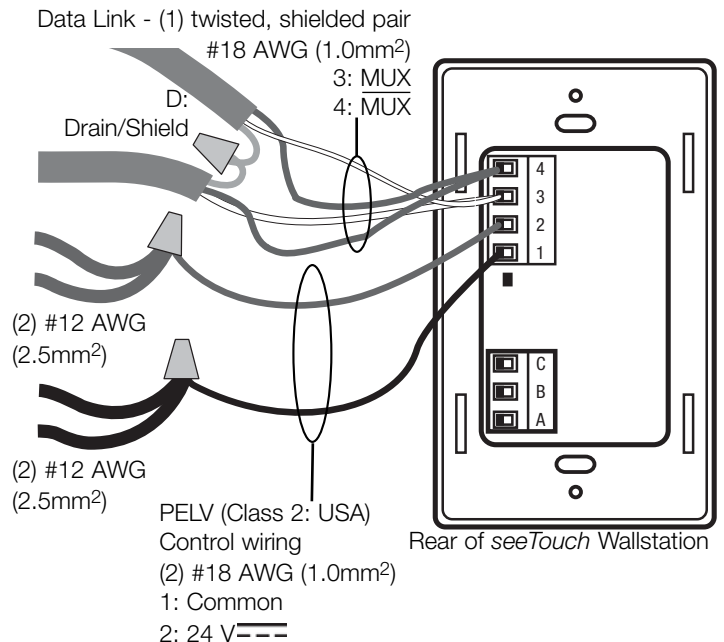

Note: Use appropriate wire connecting devices as specified by local codes.

Job Name:

Model Numbers:

Job Number:

Occupant Sensor Connection

Specifications

- No power pack required to power one occupant sensor (see next page for wiring details).
- Power Supply Output (Terminal B):
 - 24 V $\overline{=}$, 50 mA maximum.
 - An auxiliary power supply must be used if the maximum current limit is exceeded or more than one occupant sensor is connected to the wallstation (see next page for wiring details)
- Occupant Sensor Signal Input (Terminal A):
 - Input must be dry contact closure or solid-state output from the Occupant Sensor:
 - Dry Contact Closure from Occupant Sensor:
 - Referenced to Common (Terminal C) or Power Supply (Terminal B: 24 V $\overline{=}$).
 - Rated Voltage: 20 V $\overline{=}$ when open.
 - Rated Current: 0.5 mA when closed.
 - Solid-State Output from Occupant Sensor:
 - Open collector (NPN or PNP) or active-high/active-low.
 - When open collector NPN or active-low referenced to Common (Terminal C), on-state voltage at Terminal A must be less than 6 V $\overline{=}$ (at 0.3 mA).
 - When open collector PNP or active-high referenced to Power Supply (Terminal B), on-state voltage at Terminal A must be greater than 18 V $\overline{=}$ (at 0.3 mA).
 - Off-state leakage current less than ± 60 μ A.
 - Outputs must stay in the closed or open states for at least 40 msec in order to be recognized by the Wallstation.
- Wallstation is miswire protected up to 36 V $\overline{=}$.
- Wallstation supplies power for and receives a control signal back from one occupant sensor.
- See next page for wiring details.



Caution! A *seeTouch* Wallstation that is supplying power to an occupant sensor counts as 2 Control Station Devices (CSDs) on the CSD link.

Job Name:	Model Numbers:
Job Number:	

Occupant Sensor Connection (continued)

Wiring Details

Occupant Sensor Wiring

(one occupant sensor)

- Use low-voltage PELV (Class 2: USA) wiring to connect the Occupant Sensor to the Wallstation.

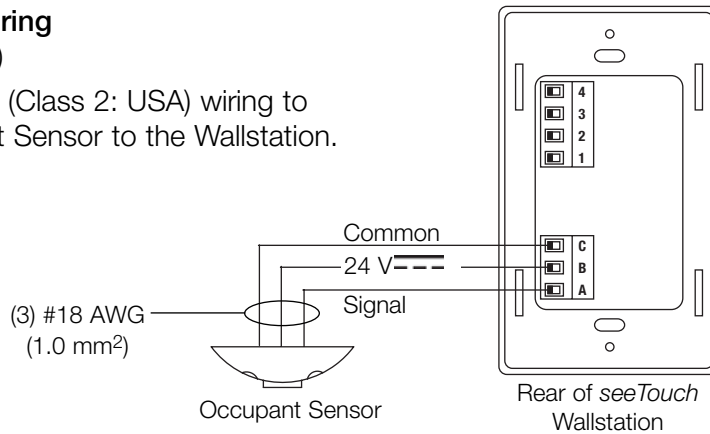

Occupant Sensor Wiring

(more than one occupant sensor)

- Use low-voltage PELV (Class 2: USA) wiring to connect the Occupant Sensors to the Wallstation.

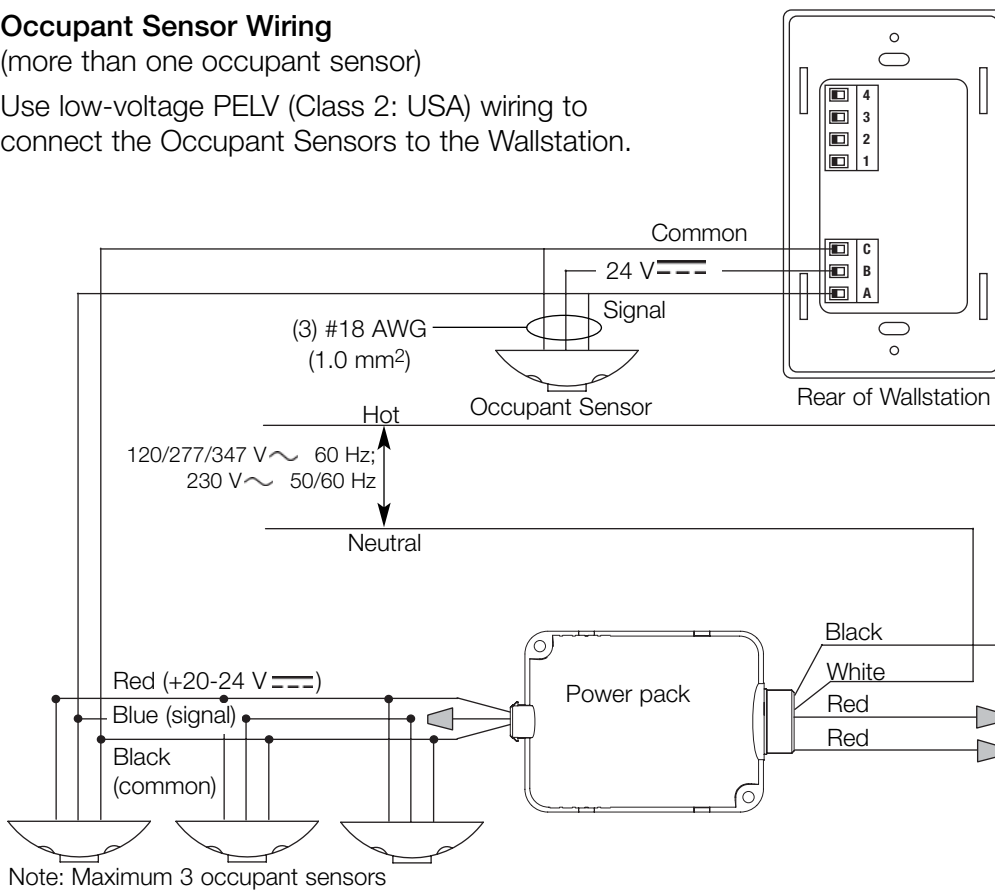

Job Name:

Model Numbers:

Job Number: