

GRAFIK Eye.

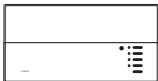

seeTouch™

Wallstations

for use with 3000 Series and 4000 Series systems

- | | |
|---------------------------------------------|--------------------------------------------|
| <input checked="" type="checkbox"/> SG-4S | <input checked="" type="checkbox"/> SG-4PS |
| <input checked="" type="checkbox"/> SG-4SIR | <input checked="" type="checkbox"/> SG-4M |
| <input checked="" type="checkbox"/> SG-4B | <input checked="" type="checkbox"/> SG-2B |
| <input checked="" type="checkbox"/> SG-4NRL | |

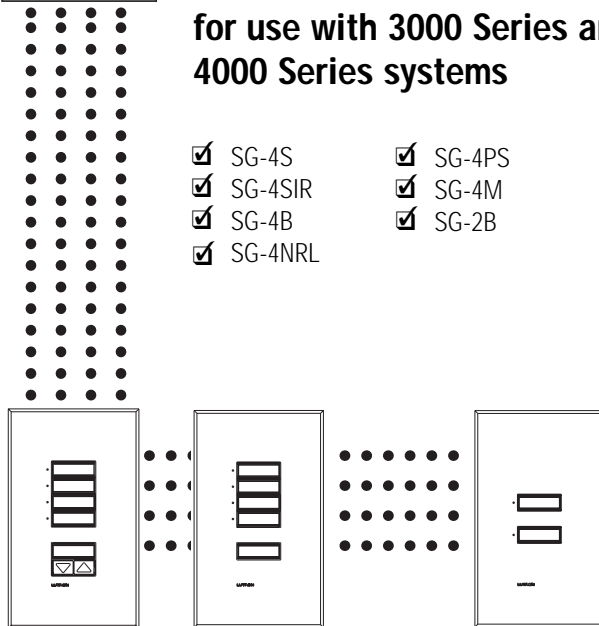

LUTRON.

Installation Instructions
Occupant Copy

Instrucciones de Instalación
Copia Para el Usuario
Favor de leer antes de instalar

Installationshinweise
Occupant Copy

Installation Instructions
Occupant Copy

Installation Instructions
Occupant Copy

Instruções de Instalação
Cópia do Usuário

ENGLISH

ESPAÑOL

DEUTSCH

FRANÇAIS

CHINESE

PORTUGUES

SG-4S, SG-4NRL (No Raise/Lower)

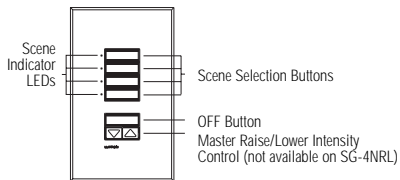

SG-4PS

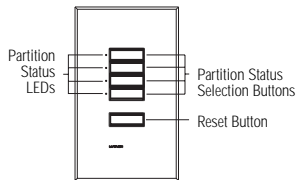

SG-4SIR

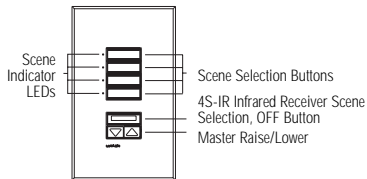

SG-4M

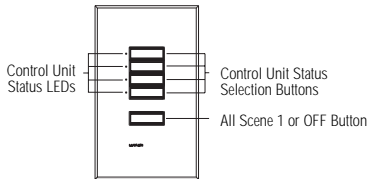

SG-4B

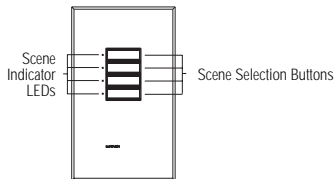

SG-2B

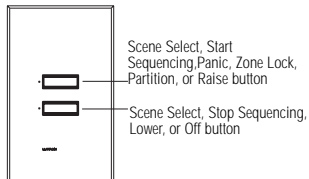

Wallstation circuits are classified as Class 2 circuits (U.S.A.) and PELV circuits (IEC). Unless otherwise specified, the voltages do not exceed 24 VAC or 15 VDC. As Class 2 circuits, they comply with the requirements of NFPA 70 National Electrical Code (NEC). As PELV circuits, they comply with the requirements of IEC 60364-4-41, VDE 0100 Part 410, BS7671:1992 and other equivalent standards. When installing and wiring to these Wallstations, follow all applicable national and/or local wiring regulations. External circuits connected to input, output, RS232, DMX512, and other communication terminals of Wallstations, must be supplied from a Listed Class 2 source or comply with the requirements for PELV circuits, as applicable in your country.

CAUTION!

- Lutron recommends that Wallstations be installed by a qualified electrician.
- Do not connect high-voltage power to low-voltage terminals. Improper wiring can result in personal injury or damage to the control or to other equipment.
- *GRAFIK Eye* Wallstations must be connected to the *GRAFIK Eye* Control Unit by using Class 2/PELV wiring methods per the National Electrical Code. Check with your local electrical inspector for the local code requirements and wiring practices allowed in your area.

Wiring Notes

- System Maximums:
 - 8 Unique *GRAFIK Eye* addresses per system.
 - 16 Wallstations per system.
 - *GRAFIK Eye* 3000 Series Control Units can power a maximum of 3 Wallstations.
 - 2000 ft. (600 m) wiring length.
 - 0 °C—40 °C operating temperature.
- Wallstation Wiring
 - 3000 Series: Four #18 AWG (1.0 mm²) Class 2/PELV wires (2 twisted, pair). Lutron offers a one-cable, non-plenum, low-voltage solution (P/N GRX-CBL-346S-500), and a one-cable, plenum, low-voltage solution (P/N GRX-PCBL346S-500). Other suggested cables are Belden No. 9156, Alpha No. 1132, or equivalent, for *GRAFIK Eye* 3000 Series Control Units.
 - 4000 Series: Two #12 AWG (2.5 mm²) Class 2/PELV wires and two shielded #18 AWG (1.0 mm²) Class 2/PELV wires (twisted, shielded pair). Lutron offers a one-cable (non-plenum), low-voltage solution (P/N GRX-CBL-46L).
 - Power: wires 1 & 2, 12 VDC-24 VFW.
 - Data: wires 3 & 4, twisted, shielded pair.
- Terminal 2 (power) must not be connected between *GRAFIK Eye* 3000 Series Control Units.

Installation



Warning: Always turn Off the circuit breaker/MCB or remove the main fuse from the power line before doing any work. Failure to do so can result in serious personal injury.

Proper wiring of Wallstations is dependent upon the *GRAFIK Eye* Control System that is providing power. *GRAFIK Eye* 3000 Series and *GRAFIK Eye* 4000 Series Control Units have different power limitations and wiring techniques. Please confirm the type of Control Unit to which the Wallstation is being wired and use the corresponding instructions that follow.

1. Turn power Off.
2. Mount standard U.S. 1-gang wallbox, 2.75 in. (70 mm) deep (available from Lutron P/N 241-519).
3. Strip insulation from wires so that 3/8 in. (10 mm) of bare wire is exposed for #18 AWG (1.0 mm²) wire.



4. Remove the faceplate, adapter (if applicable), and button assembly from the Wallstation to access DIP switches.

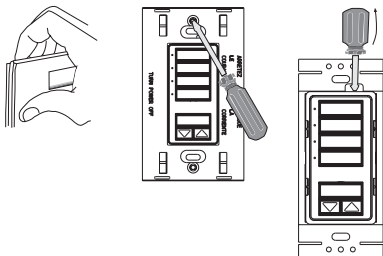

5. Address Wallstations. Each Wallstation in a system **must** be assigned a unique address. Set DIP switches 1—4 of each Wallstation to one of the positions illustrated below and record its location.



For this address

Set switches like this:	Location:	Set Switches like this:	Location:
1 ↑ ↓ ↑ ↓	1	9 ↑ ↓ ↑ ↓	9
2 ↑ ↓ ↑ ↓	2	10 ↑ ↓ ↑ ↓	10
3 ↑ ↓ ↑ ↓	3	11 ↑ ↓ ↑ ↓	11
4 ↑ ↓ ↑ ↓	4	12 ↑ ↓ ↑ ↓	12
5 ↑ ↓ ↑ ↓	5	13 ↑ ↓ ↑ ↓	13
6 ↑ ↓ ↑ ↓	6	14 ↑ ↓ ↑ ↓	14
7 ↑ ↓ ↑ ↓	7	15 ↑ ↓ ↑ ↓	15
8 ↑ ↓ ↑ ↓	8	16 ↑ ↓ ↑ ↓	16

6. Select function. Set DIP switches 5 and 6 (and 7, if applicable) on the Wallstation to select its function. DIP switch settings and their corresponding function are shown in the chart on the next page.

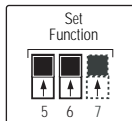

7. Select Control type. Set DIP switches 7, 8, and 9 or 8 and 9 (depending on Control type) on the Wallstation to select the Control type (refer to the Select Control Type table on the next page).

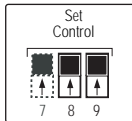



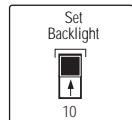









8. Backlight Option. Your Wallstation is factory set for the backlight to be On. The backlight can be switched on or off by setting DIP switch 10.







Note: If only one IR receiver is located in a room, the Wallstation may be set to select any group of four scenes. However, if more than one IR receiver is located in a room, all IR receivers in the room **must** be configured with the same scene setting. Therefore, all IR Wallstations **must** be set to include scenes 1—4 if installed in the same room with a *GRAFIK Eye Control Unit*. (*GRAFIK Eye Control Unit* scene buttons are **always** scenes 1—4.)

Select Function

Wallstation	 Factory Set			
SG-4S, SG-4SIR SG-4B, SG-4NRL	Select Scenes 1—4	Select Scenes 5—8	Select Scenes 9—12	Select Scenes 13—16
SG-4PS	Not Applicable	Not Applicable	Not Applicable	Not Applicable
SG-4M	Fifth button turns Control Units On only	Not Applicable	Not Applicable	Fifth button turns Control Units Off only

Wallstation								
SG-2B	Select Scenes 1 and Off	Select Scenes 9 and 10	Select Scenes 13 and 14	Panic Control	Fine Tuning Control	Partition Status Control	Zone Lockout	Sequence Scenes 5—16

Select Control Type

Control Type	DIP Switch Position 7 8 9
SG-4S, SG-4B, SG-4NRL	
SG-4SIR	
SG-4PS	
SG-4M	
SG-2B	Refer to the Select Function table above for Dip switch 7 position. 

9. Wiring must be done in a daisy-chain and 1-to-1 configuration (please see Installer's Guide included with Control Unit for more information). Each Wallstation terminal will accept up to two #18 AWG (1.0 mm²) wires.

3000 Series System Wiring. Connect four #18 (1.0 mm²) twisted pair wires to the Wallstation's terminal block.

4000 Series System Wiring. Connect two #18 (1.0 mm²) shielded, twisted pair wires to terminals 3 and 4 of the Wallstation's terminal block. Shielding must be connected as shown, but do not connect to Earth/Ground or Wallstation. Two #12 AWG (2.5 mm²) power wires will not fit in the terminal blocks, however, #12 AWG (2.5 mm²) is necessary due to voltage drop on the wire. Use the diagram shown at right to make the connections in the wallbox.

10. Mount WallStations as shown below. Attach faceplate by pressing in at each corner, one corner at a time. Restore power.

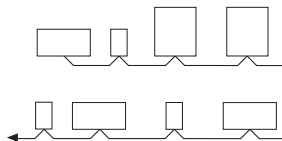

Daisy-Chain Configuration

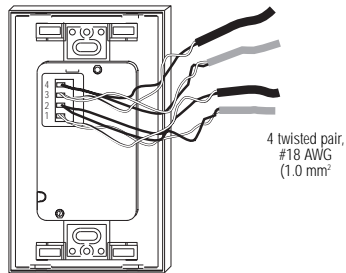

3000 Series System Wiring

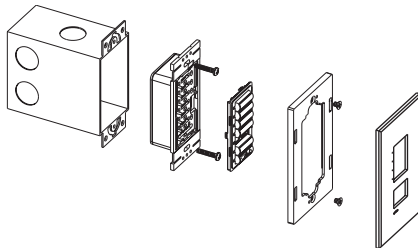

Typical Mounting Diagram

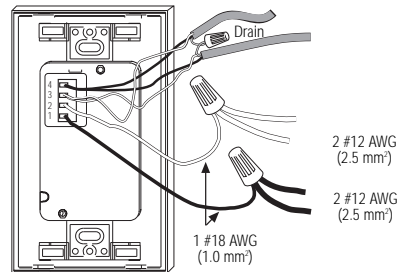

4000 Series System Wiring

System Communications

In order for Wallstations to communicate with a Control Unit, each Wallstation must be individually configured to "talk" by putting the Wallstation in setup mode.

- Put the Wallstation in setup mode (only one Wallstation can be in setup mode at a time).

SG-4S/4SIR/4B/4NRL, SG-2B: Press and hold the buttons indicated for about 3 seconds, until the LED(s) start cycling.

SG-4S/4SIR/4NRL

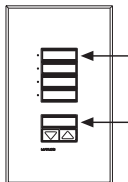

Press here
for "talk"

SG-4B

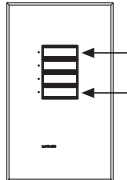

SG-2B

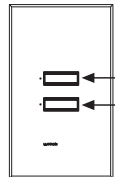

LEDs cycle

SG-4PS/SG-4M: Press and hold the buttons indicated for about 3 seconds, until the first LED flashes.

SG-4PS

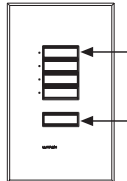

SG-4M

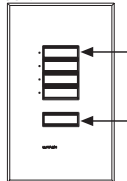

2. Identify the Control Unit(s) that you want to “listen” to this Wallstation. (Control Units must be addressed!)

SG-4S/4SIR/4B/4NRL, SG-2B: Press and hold the top Scene button on the Control Unit for about 3 seconds, until the LEDs flash in unison. Repeat for each Control Unit that you want to “listen” to the Wallstation.



LEDs flash in unison

Note: (To make a “listening” Control Unit not listen to a Wallstation in setup mode, then press the “listening” Control Unit’s OFF button until the LEDs stop flashing.)

SG-4PS and SG-4M: Control Units “listen” to individual buttons, not to the entire Wallstation. Press a button on the Wallstation so that its LED flashes. Press and hold the top Scene button on the Control Unit for about 3 seconds, until the LEDs flash in unison. Repeat for each Control Unit that you want to “listen” to this button. Repeat for the remaining buttons.

Note: (To make a “listening” Control Unit not listen to a button: Put the Wallstation in setup mode and press the button, then press the “listening” Control Unit’s OFF button until the LEDs stop flashing.)

3. **Exit setup mode.** Press and hold the buttons indicated in Step 1 for about 3 seconds, until the LEDs stop cycling (or flashing).

Internet: www.lutron.com
E-mail: product@lutron.com

WORLD HEADQUARTERS

Lutron Electronics Co., Inc.,
TOLL FREE: (800) 523-9466
(U.S.A., Canada, Caribbean)
Tel: (610) 282-3800;
International 1-610-282-3800
Fax: (610) 282-3090;
International 1-610-282-3090

ASIAN HEADQUARTERS

Lutron Asuka Co. Ltd.,
TOLL FREE: (0120) 083417 (Japan)
Tel: (03) 5405-7333;
International 81-3-5405-7333
Fax: (03) 5405-7496;
International 81-3-5405-7496

EUROPEAN HEADQUARTERS

Lutron EA Ltd.,
FREEPHONE: 0800 282107 (U.K.)
Tel: (171) 702-0657;
International 44-171-702-0657
Fax: (171) 480-6899;
International 44-171-480-6899

HONG KONG SALES OFFICE

Lutron GL (Hong Kong)
Tel: 2104-7733;
International 852-2104-7733
Fax: 2104-7633;
International 852-2104-7633

SINGAPORE

Lutron GL (Singapore)
Tel: 65 220 4666
Fax: 65 220 4333

LIMITED WARRANTY

Lutron will, at its option, repair or replace any unit that is defective in materials or manufacture within one year after purchase. For warranty service, return unit to place of purchase or mail to Lutron at 7200 Suter Rd., Coopersburg, PA 18036-1299, postage prepaid.

This warranty is in lieu of all other express warranties, and the implied warranty of merchantability is limited to one year from purchase. This warranty does not cover the cost of installation, removal, or reinstallation, or damage resulting from misuse, abuse, or improper or incorrect repair, or damage from improper wiring or installation. This warranty does not cover incidental or consequential damages. Lutron's liability on any claim for damages arising out of or in connection with the manufacture, sale, installation, delivery, or use of the unit shall never exceed the purchase price of the unit.

This warranty gives you specific legal rights, and you may also have other rights which vary from state to state. Some states do not allow limitations on how long an implied warranty lasts, so the above limitation may not apply to you. Some states do not allow the exclusion or limitation of incidental or consequential damages, so the above limitation or exclusion may not apply to you.

These products may be covered under one or more of the following U.S. patents: 4,835,343; 4,924,349; 4,954,768; DES 422,567 and DES 436,930; and corresponding foreign patents.

Lutron and *GRAFIK Eye* are registered trademarks, and *seeTouch* is a trademark of Lutron Electronics Co., Inc.

© 2001 Lutron Electronics Co., Inc.

LUTRON.

Lutron Electronics Co., Inc.
Made and printed in U.S.A.
P/N 030-731 Rev. A 11/01